

User Guide



GG IMAGE P4100 Series Black-and-white laser single-function printer



It is recommended that you read this Guide carefully before using the printer

Preface

Welcome to the GG IMAGE Series products!

We heartily appreciate your using of GG IMAGE Series products!

To protect your vital interests, please carefully read the following statements.

Legal Notice

Trademark

Microsoft®, Windows®, Windows Server® and Windows Vista® are trademarks registered by Microsoft Corporation in the United States or other countries/regions.

Apple, AirPrint and macOS are trademarks of Apple Inc., registered in the U.S. and other countries. Use of the Works with Apple badge means that an accessory has been designed to work specifically with the technology identified in the badge and has been certified by the developer to meet Apple performance standards.

Wi-Fi Direct, Wi-Fi Protected Setup (WPS), WPA, WPA2, and Wi-Fi Protected Access are marks of the Wi-Fi Alliance.

The ownership to the names of the software in this User Guide belongs to their respective companies in accordance with corresponding license agreement, and they are referred for instructions only.

All other product and brand names herein may be the registered trademarks, trademarks or service marks of their respective owners, and they are referred for instructions only.

Copyright

The Copyright of this User Guide is owned by Ninestar Corporation.

It is prohibited to copy, translate, modify and transmit this User Guide by any means or in any form without the prior written consent of Ninestar Corporation.

Version: V1.1

Disclaimer

For a better user experience, Ninestar Corporation reserves the right to make changes to the User Guide. The information contained herein is subject to change without notice.

Users are responsible for any damages arising from failing to follow this User Guide. Meanwhile, except the express warranty made in the product maintenance manual or service commitment, Ninestar Corporation does not make any express or implied warranty or guarantee to this User Guide (including composing or words).

Using this product to copy, print, scan certain documents or images or make other forms of operations may be prohibited by the local laws. If you are uncertain about the legality of using this product for certain documents or images, you should consult your legal advisor in advance.

The product can only be used safely in the non-tropical areas at an altitude no higher than 2000 meters.

Safety Precautions

Disconnect the power supply

The product should be placed close to or easily accessible to power sockets, so as to allow easy disconnection of power supply!

Laser Safety

The laser radiation is harmful to the human body. Since laser components are completely sealed in the printer, laser radiation will not leak. To avoid laser radiation, please do not randomly disassemble the printer!

The printer follows the provisions of Class 1 laser products under CFR standard. The printer has a Class III b laser diode, which has no laser radiation leakage among laser components.

The laser components shall comply with the requirements of: U.S. Code of Federal Regulations, 21 CFR 1040, IEC 60825-1.

The following label is attached to the laser components inside the printer:



Safety Warning

Please note the following safety warnings before using the printer:

Warning		
	There is high-voltage electrode inside the printer. Before cleaning the printer, make sure the power is turned off!	
	Plugging and unplugging the power cord plug with a wet hand can result in an electric shock.	
	The fuser unit is hot when and after printing. Touching the fuser unit (the shaded area as shown) may cause burns!	
	The fuser unit is attached with a high temperature warning label. Please do not remove or damage this label.	

Precautions

Precautions before Using the Printer:

1. Read and understand all instructions;
2. Familiarize yourself with the basic principles associated with operating electrical appliances;
3. Comply with all warnings and instructions marked on the equipment or specified in the manual supplied with the equipment;
4. If the operating instructions conflict with the safety information, please refer back to the safety information, as you may have misunderstood the operating instructions. If you cannot resolve the conflicts, please call the Customer Service Hotline or contact a service representative for help;
5. Before cleaning the equipment, remove the power cord from the AC power supply outlet. Do not use liquid or aerosol cleaners;
6. Please make sure that the equipment is put on a stable desktop surface to avoid serious damage caused by the falling of the equipment;
7. Do not put the equipment near a radiator, an air conditioner, or a ventilation pipe;
8. Do not put any articles on the power cord. Do not put the equipment at the place where its power cord could be stepped on by people;
9. Outlets and extension cords must not be overloaded. This may reduce performance and could result in fire or electric shock;
10. Do not allow pets to chew on the AC power cord or the computer interface cable;
11. Do not allow sharp objects piercing equipment slot, so as to avoid contact with the high-voltage device, which otherwise may result in fire or electric shock. Take care not to spill liquids onto the equipment;
12. Do not disassemble the equipment so as to avoid the risk of electric shock. Necessary repairs may only be carried out by professional maintenance personnel. Opening or removing the cover could result in an electric shock or other potential hazards. Incorrect disassembly and assembly could also result in an electric shock during future use;
13. If any one of the following occurs, disconnect the equipment from the computer and pull out the power cord from the AC wall socket and contact a qualified member of the service personnel for maintenance:
 - Liquid has been spilled into the equipment.
 - The equipment has been exposed to rain or water.
 - The equipment falls, or the cover is damaged.
 - Significant changes in the equipment's performance.
14. Only adjust the control mentioned in the instructions. Incorrect adjustment of other controls may result in damage and mean that professional maintenance personnel need to spend more time fixing it;
15. Do not use the equipment in a thunderstorm so as to avoid the risk of an electric shock. If possible, pull out the AC power cord during a thunderstorm;
16. If you continuously print multiple pages, the surface of the tray will become very hot. Take care not to touch this surface, and keep children away from this surface;
17. The signal wire of the device connected with the printer can not be connected to the outdoors;
18. Please ensure timely ventilation in case of a prolonged use or printing huge amounts of documents in a poorly ventilated room;

-
-
19. In standby status, the product will automatically enter into the power saving (sleep) mode if it does not receive any job order for a while (such as 1 minute); and it can realize zero power consumption only if it has not been connected with any external input power supply;
 20. As the Class I equipment, the product must be connected to the power supply outlet with protective grounding line when using;
 21. This product should be placed according to the shipping marks on the product package box during delivery;
 22. This product is a kind of low-voltage equipment. When using this product below the specified voltage range, please refer to the product precautions or call Aftersales Service Centre, if the toner comes off the printed contents, or the equipment starts slowly;
 23. This product is sold as a complete machine. The consumers can go to Aftersales Service Centre to purchase parts they need. If the product sold is inconsistent with the package list, please go to the specified Aftersales Service Centre to solve the problem;
 24. Install this product in a place with the temperature between 10°C and 35 and the relative humidity between 20% and 80%;
 25. Changes or modification not expressly approved by the party responsible for compliance could void the user's authority to operate the equipment.
 26. The power consumption of the product is 3.137W in networked standby if all wired network ports are connected and all wireless network ports are activated;
 27. Please keep this User Guide properly.
 28. changes or modifications not expressly approved by the party responsible for compliance could void the user's authority to operate the equipment.
 29. This equipment has been tested and found to comply with the limits for a Class B digital device, pursuant to Part 15 of the FCC Rules. These limits are designed to provide reasonable protection against harmful interference in a residential installation. This equipment generates, uses and can radiate radio frequency energy and, if not installed and used in accordance with the instructions, may cause harmful interference to radio communications. However, there is no guarantee that interference will not occur in a particular installation.

If this equipment does cause harmful interference to radio or television reception, which can be determined by turning the equipment off and on, the user is encouraged to try to correct the interference by one or more of the following measures:

 - Reorient or relocate the receiving antenna.
 - Increase the separation between the equipment and receiver.
 - Connect the equipment into an outlet on a circuit different from that to which the receiver is connected.
 - Consult the dealer or an experienced radio/TV technician for help.
 30. This equipment complies with FCC radiation exposure limits set forth for an uncontrolled environment. This equipment should be installed and operated with minimum distance 20cm between the radiator and your body. This transmitter must not be co-located or operating in conjunction with any other antenna or transmitter.

Legal Information



This symbol indicates that, at the end of your product's life, it must not be discarded as domestic waste. Instead, you should dispose of your used equipment at a designated collection point for the recycling of waste electrical and electronic equipment. Ref: EU Directive 2002/96/EC on Waste Electrical and Electronic Equipment (WEEE). Please contact your distributor / supplier for further information.



This product is suitable for indoor use only.



European Community (EC) directives conformity

This product complies with the protection requirements of EC directives 2014/30/EU and 2014/35/EU on the approximation and harmonization of the laws of the Member States relating to electromagnetic compatibility and safety of electrical equipment designed for use within certain voltage limits. The manufacturer of this product is: Unit 18 9/f New Commerce Centre NO. 9 on Lai Street, Shatin, Hong Kong, China.

A declaration of conformity to the requirements of the Directives is available upon request from the Authorized Representative.

This product satisfies the Class B limits of EN 55032 and safety requirements of EN 62368

Table of Contents

1. Before Using the Printer	1
1.1. Product series introduction	1
1.2. Supplied Accessories	2
1.3. Product View	3
1.4. Laser Toner Cartridge	5
1.5. Control Panel	6
1.5.1. Overview of control panel.....	6
1.5.2. Indicator function of control panel.....	8
2. Paper and Print Media	10
2.1. Paper Specification	10
2.2. Special Paper	11
2.3. Loading Paper	12
2.3.1. Loading into the Automatic Feeder Tray.....	12
2.3.2. Install manual feed tray	13
2.4. Non-printable Area	15
2.5. Paper application rules.....	15
3. Driver installation and uninstallation	16
3.1. How to install Windows printer driver.....	16
3.1.1. One-click Installation	16
3.1.2. Manual installation	29
3.1.3. Method of driver unistallation	36
3.2. macOS system driver installation	36
3.2.1. Driver installation	36
3.3. Add printer to macOS system.....	38
3.3.1. Add up the printer via USB.....	38
3.3.2. Add up the printer via wireline connection (applicable to wired network models)	38
3.3.3. Add up the printer via wireless connection(applicable to Wi-Fi models)	38
3.3.4. Add AirPrint printer.....	39
4. Wired network setup (applicable to wired network models)	40
4.1. Set IP Address	40
4.1.1. Automatic Setting	40
4.1.2. Manual Setting	40
5. Wireless network setup (applicable to Wi-Fi models)	41
5.1. Basic structure mode.....	41
5.1.1. Wireless network setup tools.....	41
5.1.2. Wi-Fi Protected Setup (WPS) setup	45
5.1.3. How to disable the Wi-Fi network connected.....	46
5.2. Wi-Fi Direct mode	46
5.2.1. Preliminary preparations	46
5.2.2. Wi-Fi Direct connection	46
5.2.3. How to disable the Wi-Fi Direct	47
5.3. Wireless network setup FAQs	48

6. Web server	49
6.1. Visit the embedded Web server	49
6.2. Use Web server to manage printer	50
6.2.1. IP address setup	50
6.2.2. Wireless setup	51
6.2.3. Machine setup.....	51
6.2.4. Recover factory settings via Web server	52
7. Print	53
7.1. Print Function	53
7.2. Print Settings.....	54
7.3. Cancel printing	54
7.4. Printing Mode	54
7.4.1. Printing with the Automatic Feeder Tray.....	54
7.4.2. Printing with manual feed tray	55
7.5. Automatic Two-Sided Printing	55
7.5.1. Duplex printing unit setup.....	56
7.5.2. How to carry out auto duplex printing	57
7.6. Fine mode printing	59
7.7. Mute printing	60
7.8. Auto shut-off setting	61
7.9. Open Help Document.....	62
8. Mobile Print.....	63
8.1 AirPrint mobile print.....	63
8.1.1 Operating systems supported by AirPrint mobile print.....	63
8.1.2 Preliminary preparations	63
8.1.3 How to use AirPrint mobile printing	63
9. General Settings	64
9.1. System Setting	64
9.1.1. Language Setting	64
9.1.2. Sleep Time Setting.....	65
9.1.3. Toner Save	66
9.1.4. Mute printing	66
9.1.5. Restore Factory Settings.....	67
9.1.6. Print a Page for Clean & Fix.....	67
9.1.7. Auto shut-off setting	68
9.2. Network Settings	69
9.3. Network Information	69
9.4. Print information report.....	70
10. Routine Maintenance	71
10.1. Cleaning the Printer.....	71
10.2. Toner cartridge and drum component component maintenance	73
10.2.1. About toner cartridge and drum component component.....	73
10.2.2. Replace toner cartridge and drum component.....	74

11. Troubleshooting	78
11.1. Cleaning Jammed Paper	78
11.1.1. Paper jam of auto feed tray	78
11.1.2. Paper jam of manual feed tray	79
11.1.3. Middle jam	80
11.1.4. Paper Jam in the Fuser Unit.....	82
11.1.5. Duplex Unit Jam.....	84
11.2. Software Failure	85
11.3. Common Troubleshooting	86
11.3.1. Common Problems	86
11.3.2. Image Defects	87
12. Menu Structure	90
13. Product Specifications.....	91
13.1. Overview of the Specifications.....	91

1. Before Using the Printer



1.1. Product series introduction

Product series parameters		P4100DN series	P4100DWseries	
Interface type	USB	●	●	
	NET	●	●	
	Wi-Fi		●	
Print Language	GDI			
	PDL	●	●	
Control Panel	LED			
	LCD	●	●	
Print Speed	A4	30ppm		
		33ppm	●	●
	Letter	32ppm		
		35ppm	●	●
Automatic Two-Sided Printing		●	●	
Mute printing		●	●	

(●: Support; Blank: Unsupport)

This product series is subject to additions or changes without prior notice.

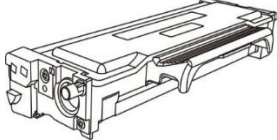
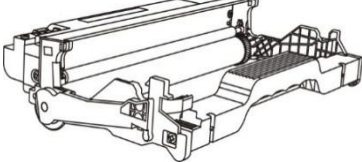
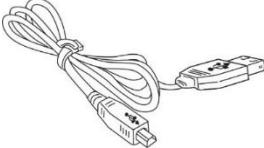
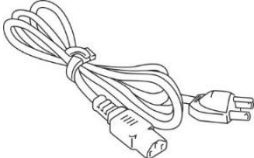
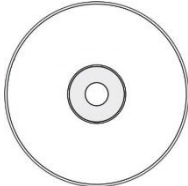
1.2. Supplied Accessories

Name	Parts
Toner cartridge	
Drum component	
USB Interface Cable	
Power Cord	
CD	
Quick Setup Guide	
GG IMAGE Warranty	



Note: • The GG IMAGE Warranty may not be attached in some regions.

1.3. Product View

Side view

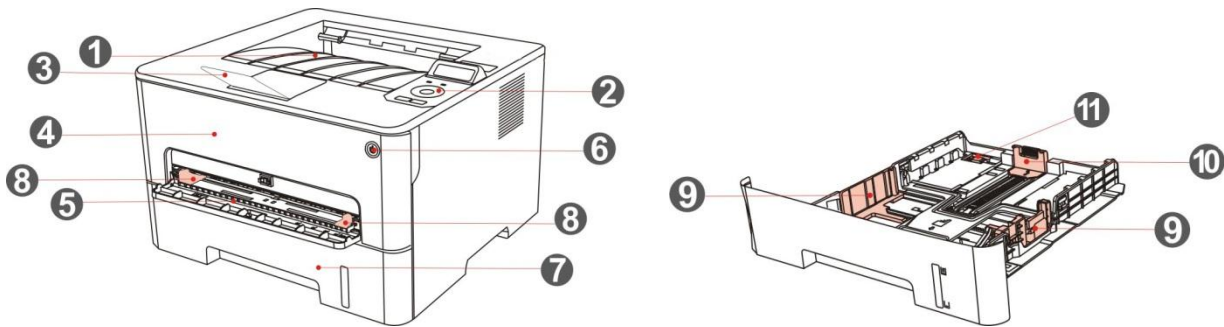

1	Output Bin	For storing the printed paper.
2	Control Panel	Indicate printer status to conduct set operation.
3	Output Tray	To prevent the printed paper from falling.
4	Front Cover	To open the front cover to take out the laser toner cartridge.
5	Manual feed tray	For placing mediums that are printed in manual feed tray.
6	Power switch	Turn the power on or off and press this button under Ready state to enter energy-saving mode. Press and hold this button for more than 2s to turn the printer power off.
7	Automatic Feeder Tray	For placing mediums that are printed in auto feed tray.
8	Paper deflector of manual feed tray	Slide paper deflector to adapt to paper width.
9	Paper width deflector of auto feed tray	Slide paper width deflector to adapt to paper width.
10	Paper length deflector of auto feed tray	Slide paper length deflector to adapt to paper length.
11	Clip of extended tray of auto feed tray	For adjustment of length extension of the tray .

Rear View

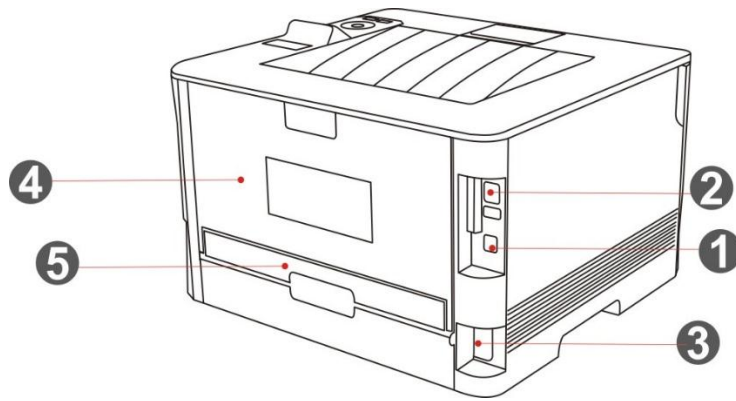

1	USB Interface	For connecting product to computer with USB cable.
2	Network Interface	For connecting product to network with network cable.
3	Power Interface	For connecting product to power with power cord.
4	Rear Cover	For paper release when it gets jammed.
5	Duplex Printing Unit	For paper feed at duplex printing and paper release when paper gets jammed at duplex printing.



Note: • Printer appearance may differ because of various models and functions, so the schematic diagram is only for your reference.

1.4. Laser Toner Cartridge

Laser toner cartridge is composed of drum component and toner cartridge.

Service life of drum component

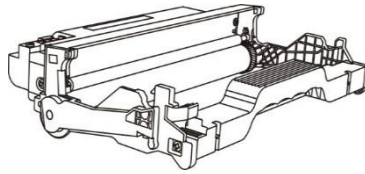

Type	Average Print Volume
High volume drum component	About 25000 Pages(Based on A4/LTR size (3pages/job))

Service life of toner cartridge

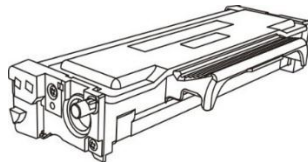

Type	Average Print Volume
Standard-volume toner cartridge	About 3000 Pages(Based on ISO 19752 standard)
High-volume toner cartridge	About 6000 Pages(Based on ISO 19752 standard)
Super large volume cartridge	About 11000 Pages(Based on ISO 19752 standard)



- Note:**
- The model is subject to increase without notice.
 - Consumables capacity may vary with different using types.
 - The Company does not recommend using consumables other than the original consumables provided, as any damages caused by non-original consumables are not covered by the scope of warranty.
 - Toner cartridge appearance may differ because of multiple volume and models, so the schematic diagram is only for your reference.
 - High volume drum component and super large volume cartridge are only applicable to some models, please refer to the specifications of the model that you actually purchase.
-

1.5. Control Panel

1.5.1. Overview of control panel

The layout of the printer control panel is shown below:

LCD control panel

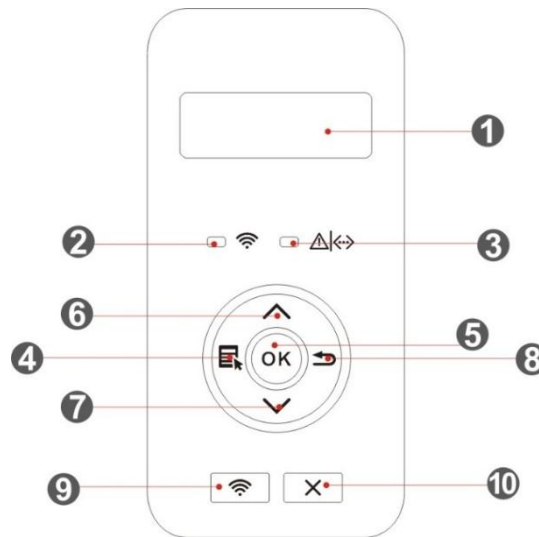

No.	Name	Functions
1	LCD Display	Display operation interface and product information.
2	Wi-Fi indicator/save toner indicator	Indicate Wi-Fi connection status (applicable to Wi-Fi model only). Indicate the on/off of save toner function (applicable to non-Wi-Fi model only). (Please refer to Chapter 1.5.2.1)
3	Toner cartridge/status indicator	Indicate the status of toner cartridge and printer (please refer to Chapter 1.5.2.1)
4	Menu	Open the main menu of control panel.
5	OK	Confirm the selection on screen.
6	UP	Scroll through the menus and options . For menu items need to input, change the numeric value by cycle accumulating.
7	Down	Scroll through the menus and options . For menu item needs to be input, shift the entry positions from left to right, for example, IP address entry.
8	Back	Return to the previous menu.
9	Wi-Fi key/save toner key	Short press Wi-Fi button to turn on direct Wi-Fi connection of the printer and automatically print out "Mobile Device Wi-Fi Connection Wizard" page (for models with Wi-Fi function only).

Long press Wi-Fi button for over 2s to start WPS when Wi-Fi is not connected or to disconnect Wi-Fi when it has already been connected (for models with Wi-Fi function only).

Open save toner function (applicable to non-Wi-Fi model only).

10	Cancel	Execute cancel operation.
----	--------	---------------------------

LED control panel

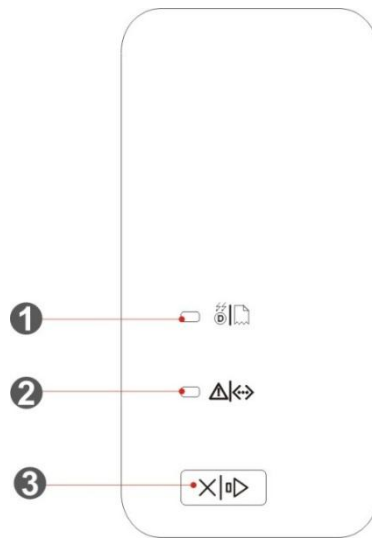



No.	Name	Functions
1	Drum/paper status indicator	Indicate the status of paper and drum component (please refer to Chapter 1.5.2.2).
2	Toner cartridge/status indicator	Indicate the status of toner cartridge and others other than paper (please refer to Chapter 1.5.2.2).
3	Cancel/continuously press key	<p>Press this button for more than 2s to cancel current printing operation under normal printing condition.</p> <p>Press this button to continue the current printing operation, or press this key for more than 2s to cancel the current printing operation when paper feed fails or it is lack of paper.</p> <p>Press this button for more than 2s to print information page at idle state.</p>







1.5.2. Indicator function of control panel

1.5.2.1. Indicator status display of LCD control panel

Display meanings of Wi-Fi / save toner indicator are as follows:





No.	Display of Wi-Fi/save toner indicator	Status	Status description (applicable to Wi-Fi model only)	Status description (applicable to non-Wi-Fi model only)
1		Die out	Wi-Fi disconnected and sleep mode	Turn save toner state function and sleep mode
2		Blue indicator blinks	Wi-Fi connecting	None
3		Blue indicator normally on	Wi-Fi connected	Turn on save toner function

Display meanings of toner cartridge / status indicator are as follows:







No.	Display of toner cartridge/status indicator	Status	Status description
1		Die out	Sleep mode
2		Green indicator blinks	Warming up, printing, print cancelling
3		Green indicator normally on	Printer is ready
4		Orange indicator blinks	Low toner warning
5		Orange indicator normally on	Toner cartridge error (uninstalled ink cartridge, unmatching ink cartridge, invalid toner cartridge)
6		Red indicator normally on	Printer errors such as paper error (paper out, paper jam, paper feed failure), opened front cover

1.5.2.2. Indicator status display of LED control panel

Display meanings of drum component/paper status indicators are as follows:

No.	Display of drum component/paper status indicators	Status	Status description
1		Die out	Sleep mode
2		Green indicator normally on	Normal drum, paper out failure
3		Red indicator normally on	Drum component error (uninstalled drum component, unmatching drum component, invalid drum component), paper error (paper out, paper jam, paper feed failure)
4		Orange indicator normally on	Drum component is about to end its expected service life

Display meanings of toner cartridge/status indicator are as follows:

No.	Display of toner cartridge/status indicator	Status	Status description
1		Die out	Sleep mode
2		Green indicator normally on	Printer is ready
3		Green indicator blinks	Warming up, printing, print cancelling
4		Red indicator normally on	Printer errors such as opened front cover
5		Orange indicator normally on	Toner cartridge error (uninstalled ink cartridge, unmatching ink cartridge, invalid toner cartridge)
6		Orange indicator blinks	Low toner warning

2. Paper and Print Media

2.1. Paper Specification

Automatic Feeder Tray	Media Type	Plain paper(70~105g/m ²),thin paper(60~70g/m ²)
	Media size	A4, Letter, A5, Legal, Statement, JIS B5, Folio, Oficio, Executive, ISO B5, A6, B6, 16K, Big 16K, 32K, Big 32K, Custom
	Media weight	60~105 g/m ²
	Maximum capacity of the tray	250 pages (80 g/m ²)
Manual feed tray	Media Type	Plain paper(70~105g/m ²),thin paper(60~70g/m ²),thick paper(105~200g/m ²),transparent film, carton paper,label paper, envelope
	Media size	A4, Letter, Legal, Folio, Oficio, Statement, Executive, JIS B5, ISO B5, A5, A6, B6, Monarch Env, DL Env, C5 Env, NO.10 Env, C6 Env, Japanese Postcard, ZL, 16K, Big 16K, 32K, Big 32K, Yougata4, Postcard, Younaga3, Nagagata3, Yougata2, Custom
	Media weight	60~200 g/m ²
	Maximum capacity of the tray	1 pages

-  **Note:**
- 80 g/m² standard paper is recommended for this printer.
 - It is not recommended to use special paper extensively, which may affect the service life of the printer.
 - The print media that does not meet the guidelines listed in this User Guide may result in poor print quality, increased paper jam and excessive wear of the printer.
 - Properties such as weight, composition, texture and humidity are important factors affecting the printer performance and output quality.

Please note the following matters when selecting the print media:

1. Desired print effect: The print media selected should meet the requirement of the print tasks.
2. Surface smoothness: The smoothness of the print media may affect the sharpness of the print outcome.
3. Some print media may meet all the use guidelines contained herein, but they still can not bring satisfactory effect. This may be due to incorrect operation, inappropriate temperature and humidity, or other factors beyond the control of GG IMAGE . Before purchasing large quantities of print media, make sure that the print media meets the specifications specified in this User Guide.

2.2. Special Paper

This printer supports using the special paper for printing. Special paper includes: label paper, envelope, transparent film, thick paper, carton paper, thin paper.



Note: • When using special paper or print media, be sure to select matched print type and size in the print settings so as to get the best print effect.

Please observe the following standards:

Types of Print Media	Correct Practices	Incorrect Practices
Label Paper	<p>Use labels with no exposed lining paper only.</p> <p>Labels shall be put flat when using.</p> <p>Use labels of full sheet only.</p> <p>There is no guarantee that all the labels in the market can meet corresponding requirements.</p>	<p>Use wrinkled, blistered or damaged label papers.</p>
Envelope	<p>Envelopes should be loaded evenly.</p>	<p>Use wrinkled, nicked, stuck or damaged envelopes.</p> <p>Use envelopes with clips, snaps, windows, or coated linings.</p> <p>Use envelopes with self-adhesive stickers or other synthetic materials.</p>
Transparent Film	<p>Only use transparent films approved for use in laser printers.</p>	<p>Use transparent print media that is not suitable for laser printers.</p>
Thick Paper, carton paper	<p>Only use heavy paper that is approved for use in laser printers and meets the weight specifications of this printer.</p>	<p>Use the paper whose weight is more than the specification of the media recommended for this printer, unless the paper is approved for use in this printer.</p>

2.3. Loading Paper

2.3.1. Loading into the Automatic Feeder Tray

1. Slide out the automatic feeder tray from the printer.

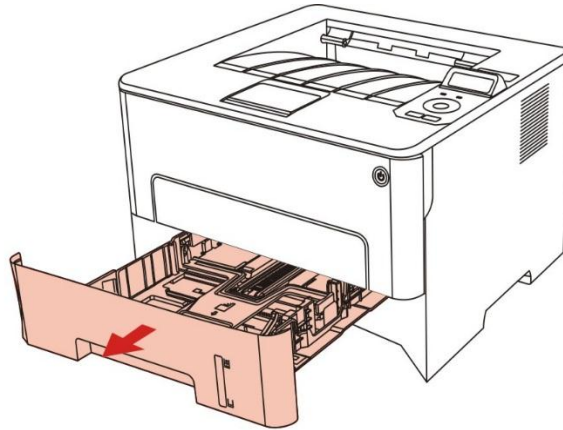

2. Slide the clip of extended tray of auto feed tray, paper length deflector and paper width deflector to the slot suitable for paper size, in order to match paper length and width.

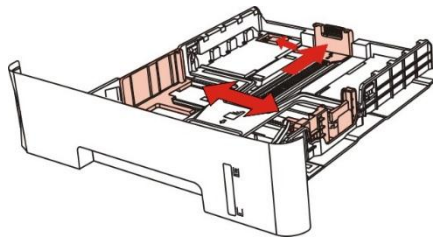

 **Note:** • Do not overly squeeze the "paper length guide" and "paper width guide", otherwise it could easily lead to deformation of paper.

3. Before loading paper, please unfold the stacked paper to avoid a paper jam or feed error, and then load the paper into the tray print-side down. The automatic feeder tray can be loaded up to 250 pages, 80g/m² paper.

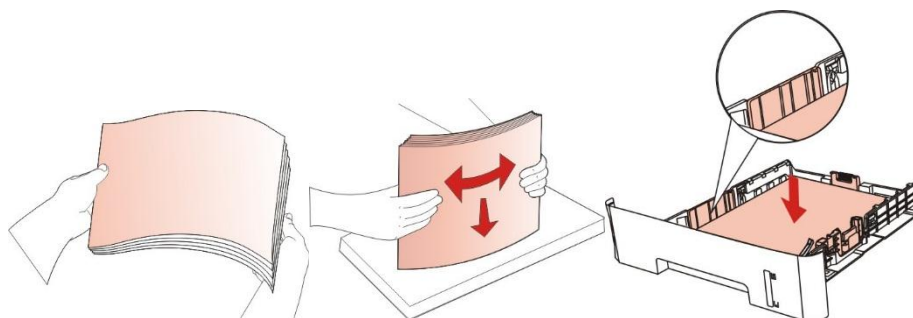

4. Raise the output tray to avoid the printed paper from slipping and falling, or immediately remove the printed document after the printing is complete.

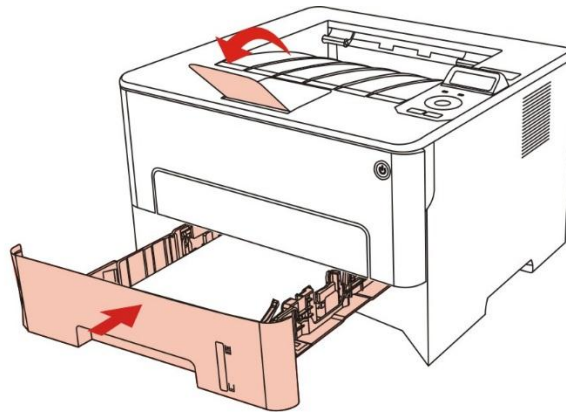

Note:

- It is recommended that you raise the output tray to prevent the paper from slipping and falling after printing. If you choose not to raise the output tray, we recommend that you immediately remove the printed paper from the printer.
- If more than 250 pages (80 g/m²) are put inside the auto feed tray at one time, paper jam or paper feed failure will be led to.
- If carrying out single-sided printing, please make sure that the side to be printed (the blank side) is face down.

2.3.2. Install manual feed tray

1. Raise the output tray to avoid the printed paper from slipping and falling, or immediately remove the printed document after the printing is complete.

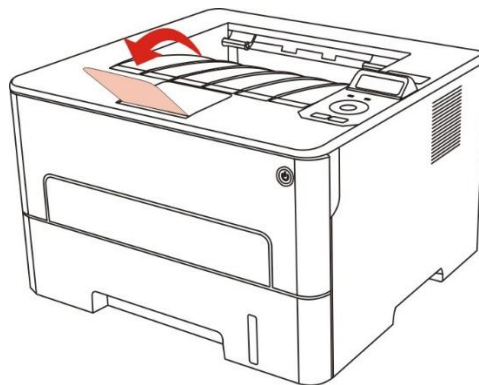

2. Open manual feed tray.

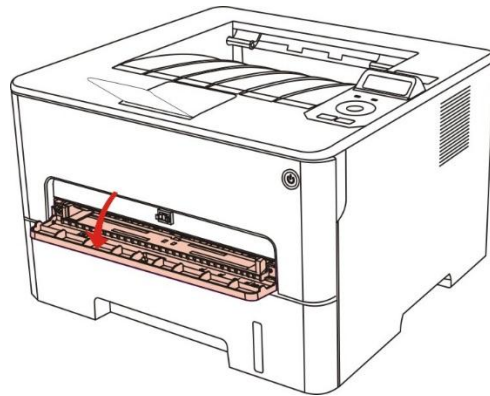

3. Slide the paper deflector of manual feed tray to match the two sides of paper. Do not use excessive force; otherwise, paper will be made jammed or skewed.

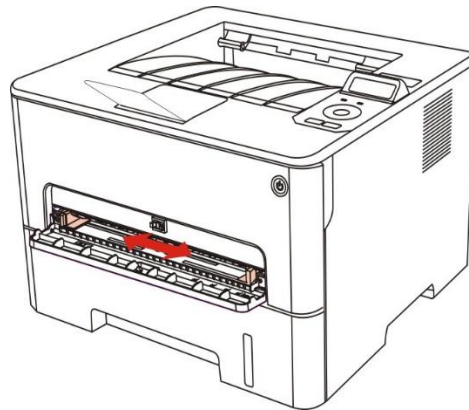

4. Put a flat printing medium into the manual feed tray with both hands.

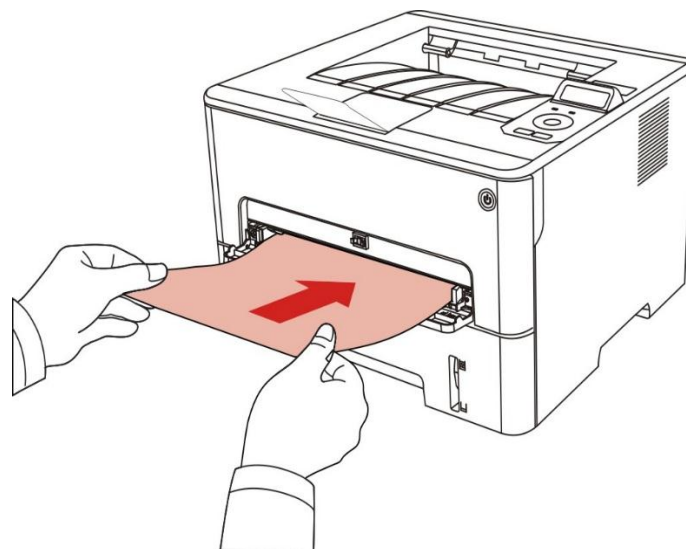



- Note:**
- The printer will enter manual feed mode automatically when you put papers inside the manual feed tray.
 - Please put one printing medium inside the manual feed tray each time and put in another piece after finishing printing.
 - Put the printing medium inside the manual feed tray with the printing side up; the top of paper should be put inside first.

5. When the printed page is output from the printer, put the second piece inside according to the above steps to continue printing. Slow action will lead to the prompt of paper out or paper failure of manual feed tray. After paper is put inside, printing will be resumed automatically; too quick action may make paper caught up in the printer, which will easily result in paper jam.



- Note:**
- After printing, please take out printed papers output from printer immediately. Stacked papers or envelopes will lead to paper jam or wrapped paper.

2.4. Non-printable Area

The shaded area indicates the non-printable area.

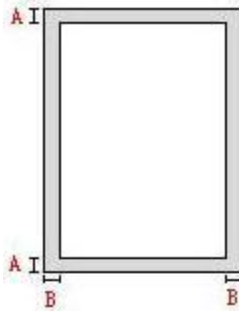

Usage	Paper Size	Top and bottom margins (A)	Left and right margins (B)
Printing	A4	5mm(0.197inch)	5mm(0.197inch)
	Letter	5mm(0.197inch)	5mm(0.197inch)

2.5. Paper application rules

- Rough textured, uneven, oil stained and extremely smooth paper will make printing effect poor.
- Please make sure that there is no dust, fluff, etc. on the paper.
- Paper shall be put on a flat surface and stored under a cool and dry environment.

3. Driver installation and uninstallation

3.1. How to install Windows printer driver

Windows driver installation software provides two installing methods: one-click installation and manual installation. We recommend one-click installation, which can help to install driver automatically in a faster and more convenient way. If you have any difficulty in using one-click installation, please try manual installation.



Note: • Driver installation interface may differ because of different models and functions, so the schematic diagram is only for your reference.

3.1.1. One-click Installation

One-click installation provides three methods of installation: connect the printer via USB cable, connect the printer via wired network, and connect the printer via wireless network. You can choose one of them according to your habit.

3.1.1.1. Method I: Connect the printer via USB cable

1. Connect the printer to computer via USB cable, power the printer and computer on.
2. Place the attached installation CD in the computer CD-ROM:
 - Windows XP system: automatically run the installation procedure.
 - Windows 7/Vista/Server 2008 system: Pop up "Autoplay" interface, click "Autorun.exe" to run the installation procedure.
 - Windows 8 system: When the "DVD RW driver" window pops up from the right top corner of computer desktop, click anywhere in the pop-up window, then click "Autorun.exe" to run the installation procedure.
 - Windows 10 system: When the "DVD RW driver" window pops up from the right top corner of computer desktop, click anywhere in the window, then click "Autorun.exe" to run the installation procedure.



Note: • Some computers may be unable to auto play the CD because of system configuration. Please double click "Computer" icon, find "DVD RW driver", then double click "DVD RW driver" to run the installation procedure.

3. Click on the "I agree" button on the right bottom corner after reading the license agreement and enter into driver installation interface.

4. Click on the "One-click installation" button in Method I and enter into the installation process. The process may need some time, and the duration is related to your computer configuration, please wait patiently.

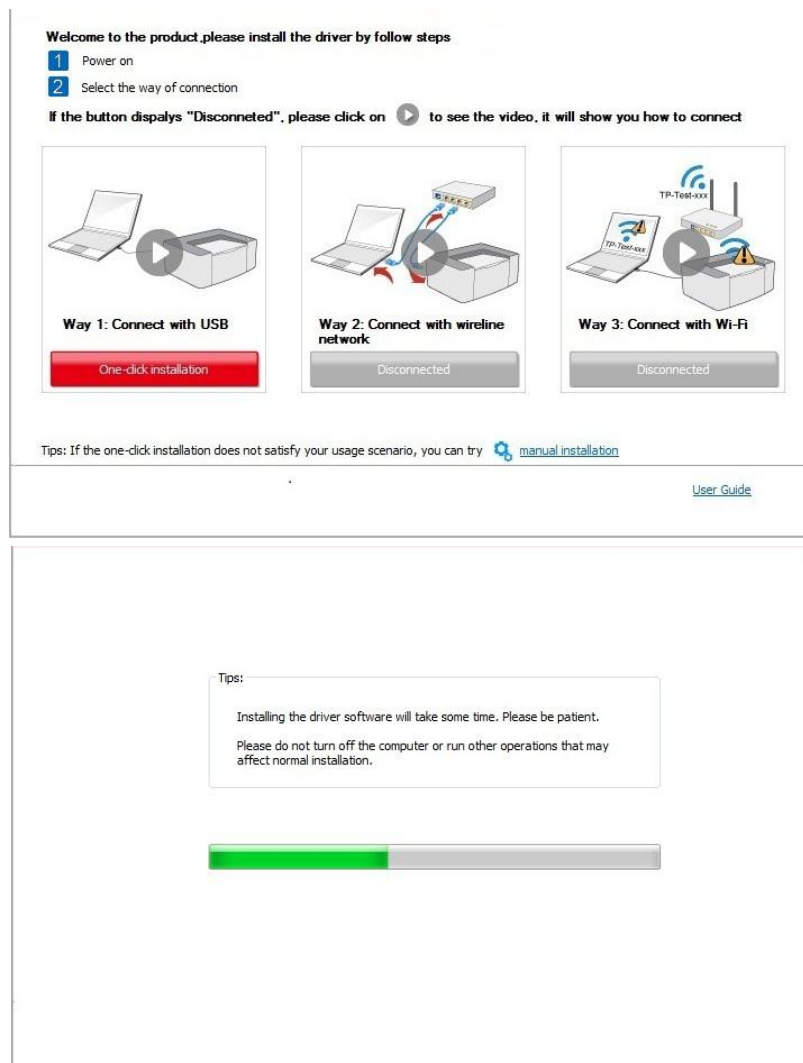

5. After the installation, click "Print & Test Page" button. If your printer prints the test page successfully, it means that you have installed the driver correctly.

3.1.1.2. Method II: Connect the printer via wired network (applicable to wired network models)

1. Turn the power of printer and computer on.
2. Connect the computer to wired network.
3. Connect network cable to the network interface of printer, to make sure the printer is connected to computer network (please refer to [Chapter 4](#) for network setup).
4. Place the attached installation CD in the computer CD-ROM:
 - Windows XP system: automatically run the installation procedure.
 - Windows 7/Vista/Server 2008 system: Pop up "Autoplay" interface, click "Autorun.exe" to run the installation procedure.

- Windows 8 system: When the "DVD RW driver" window pops up from the right top corner of computer desktop, click anywhere in the pop-up window, then click "Autorun.exe" to run the installation procedure.
- Windows 10 system: When the "DVD RW driver" window pops up from the right top corner of computer desktop, click anywhere in the window, then click "Autorun.exe" to run the installation procedure.

 **Note:** • Some computers may be unable to auto play the CD because of system configuration. Please double click "Computer" icon, find "DVD RW driver", then double click "DVD RW driver" to run the installation procedure.

5. Click on the "I agree" button on the right bottom corner after reading the license agreement and enter into driver installation interface.

6. Please click on the "One-click installation" button in Method II and install driver software.

 **Note:** • You can put your mouse cursor in the "One-click installation" button to check the popup information in order to confirm if the current printer is the one you need to install through IP address before you click the button.



- You can check the printer IP address through "Network configuration page" (Please see [Chapter 9.4](#) for how to print)
-

- Click on the "One-click installation" button to enter installation process if your software has searched only one printer. The process may need some time, and the duration is related to your computer configuration. Please wait patiently.

Welcome to the product, please install the driver by follow steps

- 1 Power on
- 2 Select the way of connection

If the button displays "Disconnected", please click on  to see the video, it will show you how to connect

 <p>Way 1: Connect with USB</p> <p>Disconnected</p>	 <p>Way 2: Connect with wireline network</p> <p>One-click installation</p>	 <p>Way 3: Connect with Wi-Fi</p> <p>Disconnected</p>
---	--	--

Tips: If the one-click installation does not satisfy your usage scenario, you can try [manual installation](#)

[User Guide](#)

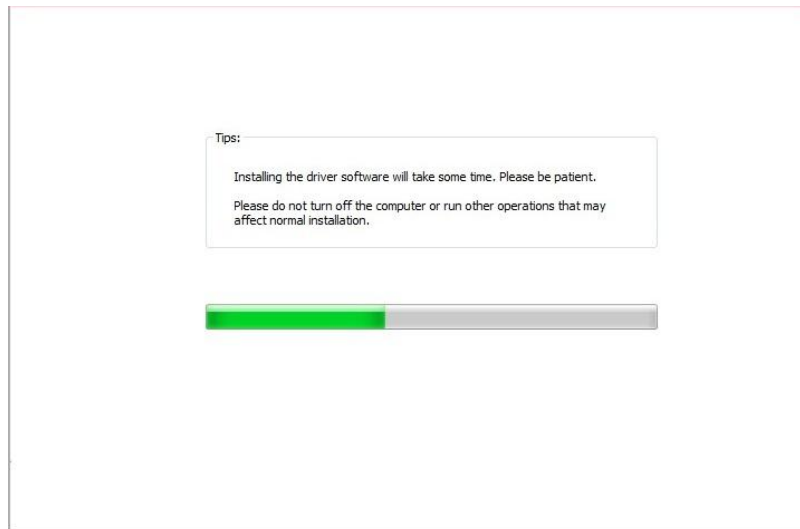

- If your software has searched several printers, click on the "One-click installation" button, and the printer list interface will pop up. Please select the printer that you need according to your printer wired network IP address or host ID.

Welcome to the product, please install the driver by follow steps

- 1 Power on
- 2 Select the way of connection

If the button displays "Disconnected", please click on to see the video, it will show you how to connect

Way 1: Connect with USB

Disconnected

Way 2: Connect with wireline network

One-click installation

Way 3: Connect with Wi-Fi

Disconnected

Tips: If the one-click installation does not satisfy your usage scenario, you can try [manual installation](#)

[User Guide](#)

Please select the printer you would like to install

Configure and install Wi-Fi via USB

Printer Name	Port

Wireline network printer

Printer Name	IP Address	Host name
<input checked="" type="checkbox"/> X X X Series PCL6 0001	10.10.148.119	X X X -04B2E7
<input type="checkbox"/> X X X Series PCL6 0002	10.10.148.155	X X X -04B304

Install the printer from the list with a hostname

Tips: If your printer is not in the list, please check the printer network status and see if it is in the same network as the current PC

-
-  **Note:**• If the printer you need is not shown in the list, please click "Refresh" button to search again. If it is not found, please check if the printer and computer are in the same network. (Please see [Chapter 5.3](#) for how to check).
- When the printer IP address changes under printer driver installed with host ID , you can also directly print without re-installing the driver. If you need to install the printer driver with the host ID, please check the option "Install the printer in the list with host ID".
-

7. After the installation, click "Print &Test Page" button. If your printer prints the test page successfully, it means that you have installed the driver correctly.

3.1.1.3. Method III: Connect the printer via wireless network(applyable to Wi-Fi models)

Please check if the printer is connected with wireless network when installing the printer driver software. If disconnected, please install it with reference to [Chapter 3.1.1.3.1](#). If connected, please install it with reference to [Chapter 3.1.1.3.2](#).

-
-  **Note:**• You can print "Network configuration page" to confirm printer network connection status to see if printer is connected with network (Please see [Chapter 9.4](#) for how to print).
-

3.1.1.3.1. The printer is not connected with wireless network(applyable to Wi-Fi models)

3.1.1.3.1.1. Configure wireless network via USB cable and install driver

Since some computers are not provided with wireless network function, this section is divided into "Connect computer to router via Wi-Fi" and "Connect computer to router via wired connection" to introduce installation process.

I. Connect computer to router via Wi-Fi

1. Computer is already connected to router via Wi-Fi.
2. Connect the printer to computer via USB cable, then power the printer on.
3. Place the attached installation CD in the computer CD-ROM:
 - Windows XP system: automatically run the installation procedure.
 - Windows 7/Vista/Server 2008 system: Pop up "Autoplay" interface, click "Autorun.exe" to run the installation procedure.
 - Windows 8 system: When the "DVD RW driver" window pops up from the right top corner of computer desktop, click anywhere in the pop-up window, then click "Autorun.exe" to run the installation procedure.
 - Windows 10 system: When the "DVD RW driver" window pops up from the right top corner of computer desktop, click anywhere in the window, then click "Autorun.exe" to run the installation procedure.

-
-  **Note:**• Some computers may be unable to auto play the CD because of system configuration. Please double click "Computer" icon, find "DVD RW driver", then double click "DVD RW driver" to run the installation procedure.
-

4. Click on the "I agree" button on the right bottom corner after reading the license agreement and enter into driver installation interface.
5. Click the "One-click installation" button in Method III to install driver software.

 **Note:**• You can put your mouse cursor in the "One-click installation" button to check the popup information in order to confirm if the current printer is the one you need to install through IP address before you click the button.

• You can check the printer IP address through "Network configuration page" (Please see [Chapter 9.4](#) for how to print)

• Click "One-click installation" button if your software has searched only one printer, and enter into installation process to complete automatic network configuration and driver installation.

Welcome to the product, please install the driver by follow steps

- 1 Power on
- 2 Select the way of connection

If the button displays "Disconnected", please click on  to see the video, it will show you how to connect



Way 1: Connect with USB

One-click installation



Way 2: Connect with wireline network

Disconnected



Way 3: Connect with Wi-Fi

One-click installation

Tips: If the one-click installation does not satisfy your usage scenario, you can try [manual installation](#)

[User Guide](#)

Tips:

Installing the driver software will take some time. Please be patient.
Please do not turn off the computer or run other operations that may affect normal installation.



- If your software has searched several printers, click "One-click installation" button, and the printer list interface will pop up. Please select "Configure printer with Wi-Fi via USB and install" and select USB printer, click "Confirm" button and enter into installation process to complete automatic network configuration and driver installation.

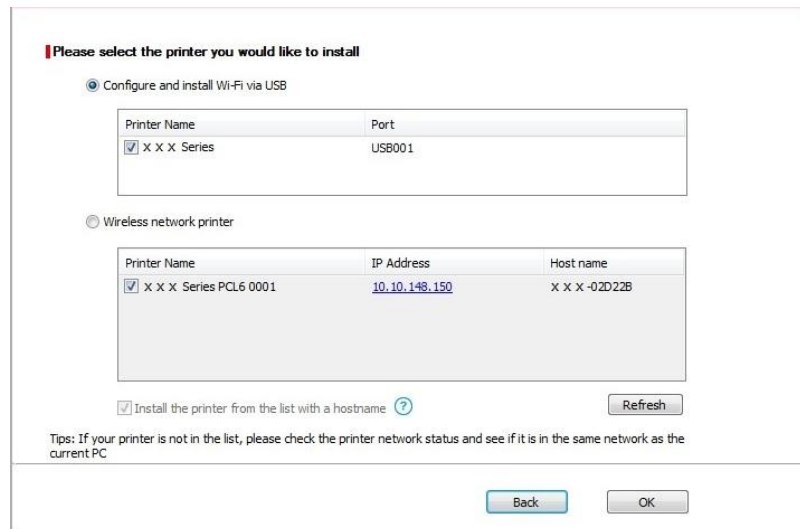
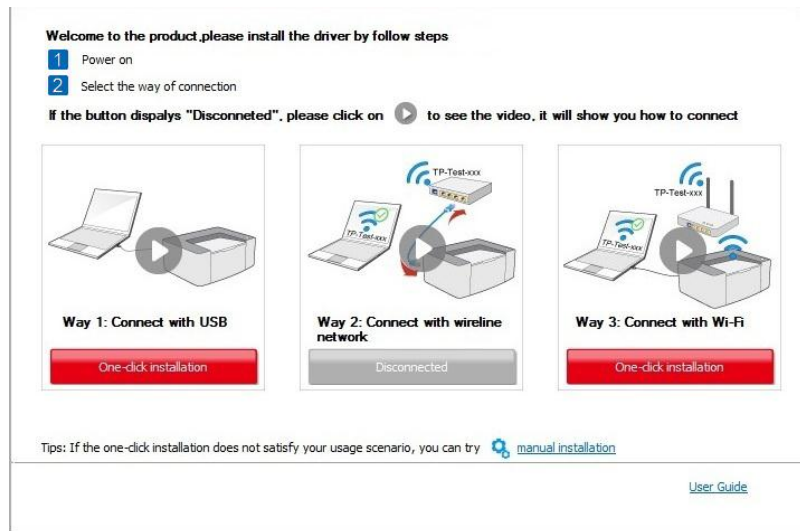

Note:• When the printer IP address changes under printer driver installed with host ID , you can also directly print without re-installing the driver. If you need to install the printer driver with the host ID, please check the option "Install the printer in the list with host ID".

6. After the installation, click "Print & Test Page" button. If your printer prints the test page successfully, it means that you have installed the driver correctly.

II. Connect computer to router via network cable

1. Connect computer to router via network cable.
2. Connect the printer to computer via USB cable, then power the printer on.
3. Place the attached installation CD in the computer CD-ROM:
 - Windows XP system: automatically run the installation procedure.
 - Windows 7/Vista/Server 2008 system: Pop up "Autoplay" interface, click "Autorun.exe" to run the installation procedure.
 - Windows 8 system: When the "DVD RW driver" window pops up from the right top corner of computer desktop, click anywhere in the pop-up window, then click "Autorun.exe" to run the installation procedure.
 - Windows 10 system: When the "DVD RW driver" window pops up from the right top corner of computer desktop, click anywhere in the window, then click "Autorun.exe" to run the installation procedure.

 **Note:** • Some computers may be unable to auto play the CD because of system configuration. Please double click "Computer" icon, find "DVD RW driver", then double click "DVD RW driver" to run the installation procedure.

4. Click on the "I agree" button on the right bottom corner after reading the license agreement and enter into driver installation interface.
5. Please click on the "One-click installation" button in Method III and install driver software.

 **Note:** • You can put your mouse cursor in the "One-click installation" button to check the popup information in order to confirm if the current printer is the one you need to install through IP address before you click the button.

- You can check the printer IP address through "Network configuration page" (Please see [Chapter 9.4](#) for how to print).

- Click on the "One-click installation" button if your software has only searched only one printer, and the wireless network configuration interface will pop up, input the SSID and password that you need, then click "Confirm" button, and enter into installation process. The process may need some time, and the duration is related to your computer configuration, please wait patiently.

Welcome to the product, please install the driver by follow steps

- 1 Power on
- 2 Select the way of connection

If the button displays "Disconnected", please click on  to see the video, it will show you how to connect



Way 1: Connect with USB

One-click installation



Way 2: Connect with wireline network

Disconnected



Way 3: Connect with Wi-Fi

One-click installation

Tips: If the one-click installation does not satisfy your usage scenario, you can try [manual installation](#)

[User Guide](#)

1. Please click on "Printing wireless network information page" to get the network name and encryption method. Please skip this step if you already know the network name and encryption method.

[Printing wireless network information page](#)

2. Please enter wireless network user name and password.

Network Name(SSID):

Encryption method:

Password:

Show password:

- If your software has searched more than one printers, the printer list interface will pop up. You need to configure the current printer which is connected via USB cable to wireless network and install driver. Please select "Configure the print via USB and install" on the printer list interface and check the USB printer option. Click the "Confirm" button, and the wireless network configuration interface will pop up. Input the wireless SSID and password that you need, then click "Confirm" button, and enter into installation process. The process may need some time, and the duration is related to your computer configuration, please wait patiently.

Welcome to the product, please install the driver by follow steps

- 1 Power on
- 2 Select the way of connection

If the button displays "Disconnected", please click on  to see the video, it will show you how to connect



Way 1: Connect with USB

One-click installation



Way 2: Connect with wireline network

Disconnected



Way 3: Connect with Wi-Fi

One-click installation

Tips: If the one-click installation does not satisfy your usage scenario, you can try  [manual installation](#)

[User Guide](#)

Please select the printer you would like to install

Configure and install Wi-Fi via USB

Printer Name	Port
<input checked="" type="checkbox"/> X X X Series	USB001

Wireless network printer

Printer Name	IP Address	Host name
<input checked="" type="checkbox"/> X X X Series PCL6 0001	10.10.148.150	X X X -02D22B

Install the printer from the list with a hostname  Refresh

Tips: If your printer is not in the list, please check the printer network status and see if it is in the same network as the current PC

Back
OK

1. Please click on "Printing wireless network information page" to get the network name and encryption method. Please skip this step if you already know the network name and encryption method.

Printing wireless network information page

2. Please enter wireless network user name and password.

Network Name(SSID):

Encryption method:

Password:

Show password:

Back
OK

 **Note:**• When the printer IP address changes under printer driver installed with host ID , you can also directly print without re-installing the driver. If you need to install the printer driver with the host ID, please check the option "Install the printer in the list with host ID".

6. After the installation, click "Print & Test Page" button. If your printer prints the test page successfully, it means that you have installed the driver correctly.

3.1.1.3.1.2. Connect computer to printer via Wi-Fi direct and install the driver

Connect the computer to printer via a direct Wi-Fi connection. It is applicable to wireless network without infrastructure mode, but it still needs scenario of temporary use of printer via wireless network. You can directly connect the computer that has wireless function to the printer to realize printing function.

1. Turn the power of printer and computer on.
2. Connect computer to the Wi-Fi Direct network of the printer (please refer to [Chapter 5.2.2.2](#) for setup method).
3. Place the attached installation CD in the computer CD-ROM:
 - Windows XP system: automatically run the installation procedure.
 - Windows 7/Vista/Server 2008 system: Pop up "Autoplay" interface, click "Autorun.exe" to run the installation procedure.
 - Windows 8 system: When the "DVD RW driver" window pops up from the right top corner of computer desktop, click anywhere in the pop-up window, then click "Autorun.exe" to run the installation procedure.
 - Windows 10 system: When the "DVD RW driver" window pops up from the right top corner of computer desktop, click anywhere in the window, then click "Autorun.exe" to run the installation procedure.

 **Note:**• Some computers may be unable to auto play the CD because of system configuration. Please double click "Computer" icon, find "DVD RW driver", then double click "DVD RW driver" to run the installation procedure.

4. Click on the "I agree" button on the right bottom corner after reading the license agreement and enter into driver installation interface.

5. Click on the "One-click installation" button in Method III, and enter into installation process. The process may need some time, and the duration is related to your computer configuration, please wait patiently.

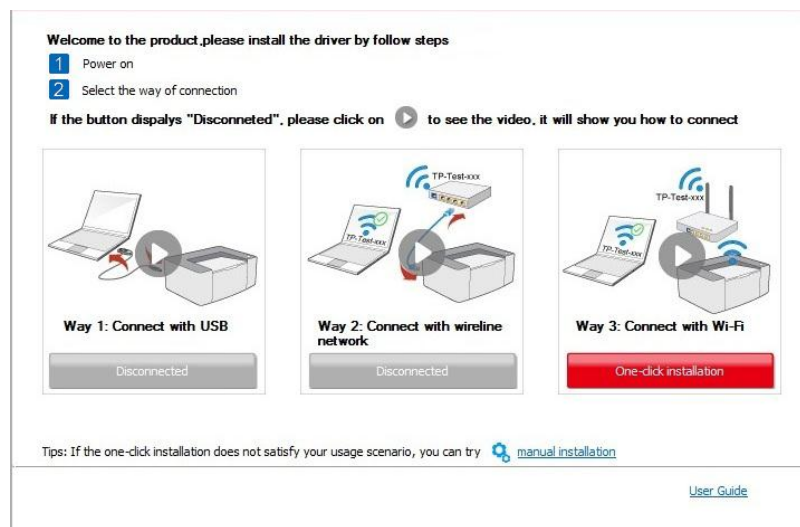

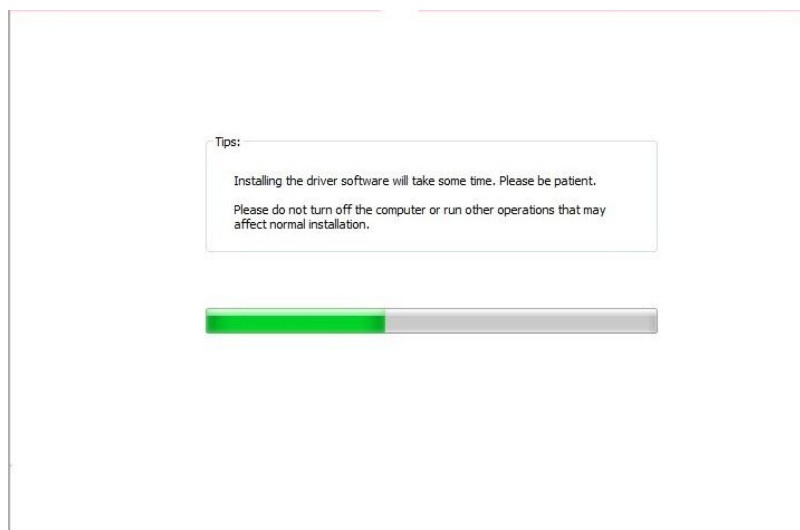

6. After the installation, click "Print & Test Page" button. If your printer prints the test page successfully, it means that you have installed the driver correctly.

3.1.1.3.2. The printer is already connected to wireless network

1. The printer is already connected to wireless network, you can print the "Network configuration page" to check. (See [Chapter 9.4](#) to for how to print).

2. Connect the computer to printer network.

3. Place the attached installation CD in the computer CD-ROM:

- Windows XP system: automatically run the installation procedure.
- Windows 7/Vista/Server 2008 system: Pop up "Autoplay" interface, click "Autorun.exe" to run the installation procedure.
- Windows 8 system: When the "DVD RW driver" window pops up from the right top corner of computer desktop, click anywhere in the pop-up window, then click "Autorun.exe" to run the installation procedure.
- Windows 10 system: When the "DVD RW driver" window pops up from the right top corner of computer desktop, click anywhere in the window, then click "Autorun.exe" to run the installation procedure.

 **Note:** • Some computers may be unable to auto play the CD because of system configuration. Please double click "Computer" icon, find "DVD RW driver", then double click "DVD RW driver" to run the installation procedure.

4. Click on the "I agree" button on the right bottom corner after reading the license agreement and enter into driver installation interface.

5. Click the "One-click installation" button in Method III to install driver software.

 **Note:** • You can put your mouse cursor in the "One-click installation" button to check the popup information in order to confirm if the current printer is the one you need to install through IP address before you click the button.

- You can check the printer IP address through "Network configuration page" (Please see [Chapter 9.4](#) for how to print)

- Click on the "One-click installation" button to enter installation process if your software has searched only one printer. The process may need some time, and the duration is related to your computer configuration. Please wait patiently.

Welcome to the product, please install the driver by follow steps

- 1 Power on
- 2 Select the way of connection

If the button dispalys "Disconnected", please click on  to see the video, it will show you how to connect



Way 1: Connect with USB

Disconnected



Way 2: Connect with wireline network

Disconnected



Way 3: Connect with Wi-Fi

One-click installation

Tips: If the one-click installation does not satisfy your usage scenario, you can try [manual installation](#)

[User Guide](#)

Tips:

Installing the driver software will take some time. Please be patient.

Please do not turn off the computer or run other operations that may affect normal installation.



- If the software has searched several printers, the printer list interface will pop up. Please select the printer you need according to your printer wired network IP address or host ID .

Welcome to the product, please install the driver by follow steps

- 1 Power on
- 2 Select the way of connection

If the button dispalys "Disconnected", please click on  to see the video, it will show you how to connect



Way 1: Connect with USB

Disconnected



Way 2: Connect with wireline network

Disconnected



Way 3: Connect with Wi-Fi

One-click installation

Tips: If the one-click installation does not satisfy your usage scenario, you can try [manual installation](#)

[User Guide](#)

Please select the printer you would like to install

Configure and install Wi-Fi via USB

Printer Name	Port

Wireless network printer

Printer Name	IP Address	Host name
<input checked="" type="checkbox"/> X X X Series PCL6 0001	10.10.148.150	X X X -02D22B
<input type="checkbox"/> X X X Series PCL6 0002	10.10.148.152	X X X -02D84A

Install the printer from the list with a hostname 

Tips: If your printer is not in the list, please check the printer network status and see if it is in the same network as the current PC.

-
-  **Note:** • If the printer you need is not shown in the list, please click "Refresh" button to search again. If it is not found, please check if the printer and computer are in the same network. (Please see [Chapter 5.3](#) for how to check).
- When the printer IP address changes under printer driver installed with host ID , you can also directly print without re-installing the driver. If you need to install the printer driver with the host ID, please check the option "Install the printer in the list with host ID".
-

6. After the installation, click "Print & Test Page" button. If your printer prints the test page successfully, it means that you have installed the driver correctly.

3.1.2. Manual installation

- Before installing the drive, you need to learn about printer model by printing printer information page out and check the product name (please refer to [Chapter 9.4](#) for printing methods).

3.1.2.1. Installation via USB connection

1. Connect the printer to computer via USB cable, power the printer and computer on.
2. Place the attached installation CD in the computer CD-ROM:
 - Windows XP system: automatically run the installation procedure.
 - Windows 7/Vista/Server 2008 system: Pop up "Autoplay" interface, click "Autorun.exe" to run the installation procedure.
 - Windows 8 system: When the "DVD RW driver" window pops up from the right top corner of computer desktop, click anywhere in the pop-up window, then click "Autorun.exe" to run the installation procedure.
 - Windows 10 system: When the "DVD RW driver" window pops up from the right top corner of computer desktop, click anywhere in the window, then click "Autorun.exe" to run the installation procedure.

-
-  **Note:** • Some computers may be unable to auto play the CD because of system configuration. Please double click "Computer" icon, find "DVD RW driver", then double click "DVD RW driver" to run the installation procedure.
-

3. Click on the "I agree" button on the right bottom corner after reading the license agreement and enter into driver installation interface.

4. Click on the "Manual installation" at the bottom of driver installation interface, and enter into manual installation interface.
5. Please select installation language and printer model.
6. Select "Connect via USB" and click on "Install".

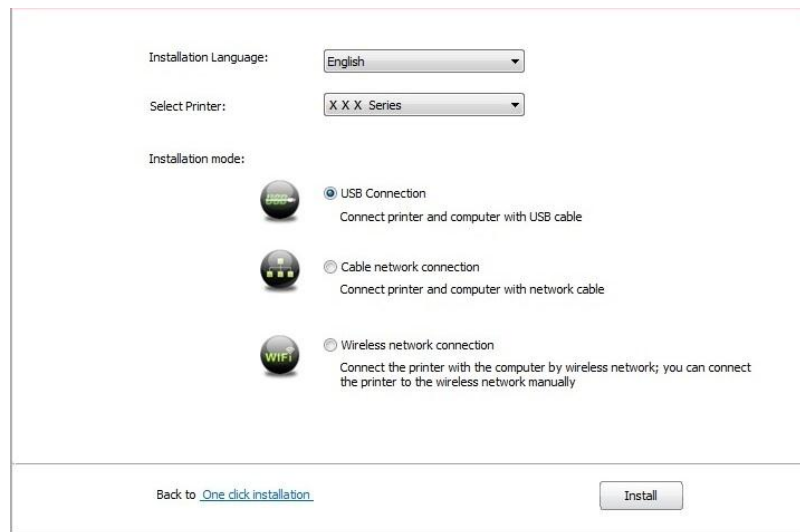

7. The software installs the driver automatically and the installation process may need some time. The duration is related to your computer configuration, please wait patiently.
8. After the installation, click "Print & Test Page" button. If your printer prints the test page successfully, it means that you have installed the driver correctly.

3.1.2.2. Installation via wired network connection (applicable to wired network models)

1. Turn the power of printer and computer on.
2. Connect the computer to wired network.
3. Connect network cable to the network interface of printer, to make sure the printer is connected to computer network (please refer to [Chapter 4](#) for network setup).
4. Place the attached installation CD in the computer CD-ROM:
 - Windows XP system: automatically run the installation procedure.
 - Windows 7/Vista/Server 2008 system: Pop up "Autoplay" interface, click "Autorun.exe" to run the installation procedure.
 - Windows 8 system: When the "DVD RW driver" window pops up from the right top corner of computer desktop, click anywhere in the pop-up window, then click "Autorun.exe" to run the installation procedure.
 - Windows 10 system: When the "DVD RW driver" window pops up from the right top corner of computer desktop, click anywhere in the window, then click "Autorun.exe" to run the installation procedure.

 **Note:** • Some computers may be unable to auto play the CD because of system configuration. Please double click "Computer" icon, find "DVD RW driver", then double click "DVD RW driver" to run the installation procedure.

5. Click on the "I agree" button on the right bottom corner after reading the license agreement and enter into driver installation interface.

6. Click on the "Manual installation" at the bottom of driver installation interface, and enter into manual installation interface.
7. Please select installation language and printer model.
8. Select "Wireline network connection" and click on "Install".

The screenshot shows a software installation window with the following elements:

- Installation Language:** A dropdown menu set to "English".
- Select Printer:** A dropdown menu set to "X X X Series".
- Installation mode:** Three radio button options:
 - USB Connection:** Connect printer and computer with USB cable.
 - Cable network connection:** Connect printer and computer with network cable. This option is selected.
 - Wireless network connection:** Connect the printer with the computer by wireless network; you can connect the printer to the wireless network manually.
- Navigation:** A link "Back to [One click installation](#)" and an "Install" button.

9. The installation software will search the printer automatically and the searching process may need some time.
10. After finishing searching, select the printer that needs to be connected and click "Next".

The screenshot shows a "Detected Printer" dialog box with the following elements:

- Detected Printer:** A table with columns for Printer Name, IP Address, and Host name.

Printer Name	IP Address	Host name
<input checked="" type="checkbox"/> X X X Series PCL6 0001	10.10.148.140	X X X -779888
- Installation Options:**
 - Install the printer from the list with a hostname. Includes a "Refresh" button.
 - Add the IP address or hostname manually. Includes an empty text input field.
- Navigation:** "Previous", "Next", and "Exit" buttons.



Note:• If the printer you need to connect is not in the list of printers searched, please click "Refresh" to search again.

- When the printer IP address changes under printer driver installed with host ID , you can also directly print without re-installing the driver. If you need to install the printer driver with the host ID, please check the option "Install the printer in the list with host ID".
- If IP address or host name is added manually, you need to know the IP address of the printer connected or host name. If they are not made clear, please print the "NetConf Pg" and view "IP Address" and "Host name" (Please refer to [Chapter 9.4](#)).

11. The software installs the driver automatically and the installation process may need some time. The duration is related to your computer configuration, please wait patiently.

12. After the installation, click "Print & Test Page" button. If your printer prints the test page successfully, it means that you have installed the driver correctly.

3.1.2.3. Installation by wireless network connection mode (applicable to Wi-Fi models)

Wireless network connection type is divided into basic structure mode and Wi-Fi Direct mode (please refer to [Chapter 5](#) for details).

3.1.2.3.1. Installation in basic structure mode

1. Connect computer to access point (wireless router).
2. Connect the printer to computer via USB cable, then power the printer on.
3. Place the attached installation CD in the computer CD-ROM:
 - Windows XP system: automatically run the installation procedure.
 - Windows 7/Vista/Server 2008 system: Pop up "Autoplay" interface, click "Autorun.exe" to run the installation procedure.
 - Windows 8 system: When the "DVD RW driver" window pops up from the right top corner of computer desktop, click anywhere in the pop-up window, then click "Autorun.exe" to run the installation procedure.
 - Windows 10 system: When the "DVD RW driver" window pops up from the right top corner of computer desktop, click anywhere in the window, then click "Autorun.exe" to run the installation procedure.



Note: • Some computers may be unable to auto play the CD because of system configuration. Please double click "Computer" icon, find "DVD RW driver", then double click "DVD RW driver" to run the installation procedure.

4. Click on the "I agree" button on the right bottom corner after reading the license agreement and enter into driver installation interface.
5. Click on the "Manual installation" at the bottom of driver installation interface, and enter into manual installation interface.
6. Please select installation language and printer model.
7. Select "Wireless network connection" and click on "Install".

The screenshot shows a software installation window with the following elements:

- Installation Language:** A dropdown menu set to "English".
- Select Printer:** A dropdown menu set to "X X X Series".
- Installation mode:** Three radio button options:
 - USB Connection**
Connect printer and computer with USB cable
 - Cable network connection**
Connect printer and computer with network cable
 - Wireless network connection**
Connect the printer with the computer by wireless network; you can connect the printer to the wireless network manually
- Bottom Bar:** A link "Back to [One click installation](#)" on the left and an "Install" button on the right.

8. Select “Yes, I want to configurate the printer's wireless network” on the wireless setup window popped out, and operate according to the prompts to set up the printer to wireless network (please refer to [Chapter 5.1.1](#) for setup method).

The installation program will determine whether wireless network of the printer is to be configured based on your choice in this step;

- if you need to configure or change wireless network of the printer, please select “yes” after the printer connects USB;
- if not, please select “no”.

Yes, I want to configurate the printer's wireless network.

No, the printer has been connected to wireless network.

Previous Next Exit

9. The installation software will search the printer automatically after wireless network is configured successfully. The search process may need some time.

10. Select the printer needs to be connected and click “Next”.

Detected Printer

Printer Name	IP Address	Host name
<input checked="" type="checkbox"/> X X X Series PCL6 0001	10.10.148.140	X X X -7796BB

Install the printer from the list with a hostname Refresh

Add the IP address or hostname manually

Previous Next Exit

 **Note:**• If the printer you need to connect is not in the list of printers searched, please click “Refresh” to search again.

- When the printer IP address changes under printer driver installed with host ID , you can also directly print without re-installing the driver. If you need to install the printer driver with the host ID, please check the option "Install the printer in the list with host ID".
 - If IP address or host name is added manually, you need to know the IP address of the printer connected or host name. If they are not made clear, please print the “NetConf Pg” and view “IP Address” and “Host name” (Please refer to [Chapter 9.4](#)).
-

11. The software installs the driver automatically and the installation process may need some time. The duration is related to your computer configuration, please wait patiently.

12. After the installation, click "Print &Test Page" button. If your printer prints the test page successfully, it means that you have installed the driver correctly.

3.1.2.3.2. Installation in Wi-Fi Direct mode

1. Turn the power of printer and computer on.
2. Connect computer to the Wi-Fi Direct network of the printer (please refer to [Chapter 5.2.2.2](#) for setup method).
3. Place the attached installation CD in the computer CD-ROM:
 - Windows XP system: automatically run the installation procedure.
 - Windows 7/Vista/Server 2008 system: Pop up "Autoplay" interface, click "Autorun.exe" to run the installation procedure.
 - Windows 8 system: When the "DVD RW driver" window pops up from the right top corner of computer desktop, click anywhere in the pop-up window, then click "Autorun.exe" to run the installation procedure.
 - Windows 10 system: When the "DVD RW driver" window pops up from the right top corner of computer desktop, click anywhere in the window, then click "Autorun.exe" to run the installation procedure.

 **Note:** • Some computers may be unable to auto play the CD because of system configuration. Please double click "Computer" icon, find "DVD RW driver", then double click "DVD RW driver" to run the installation procedure.

4. Click on the "I agree" button on the right bottom corner after reading the license agreement and enter into driver installation interface.
5. Click on the "Manual installation" at the bottom of driver installation interface, and enter into manual installation interface.
6. Please select installation language and printer model.
7. Select "Wireless network connection" and click on "Install".

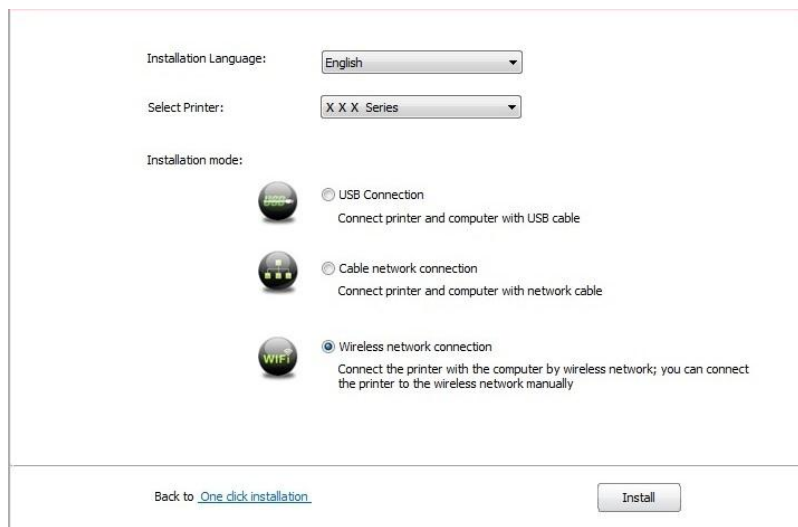

The screenshot shows a software installation window with the following elements:

- Installation Language:** A dropdown menu currently set to "English".
- Select Printer:** A dropdown menu currently set to "X X X Series".
- Installation mode:** Three radio button options:
 - USB Connection**
Connect printer and computer with USB cable
 - Cable network connection**
Connect printer and computer with network cable
 - Wireless network connection**
Connect the printer with the computer by wireless network; you can connect the printer to the wireless network manually

At the bottom of the window, there is a link "Back to [One click installation](#)" on the left and an "Install" button on the right.

8. Select “No, the printer has been connected to wireless network” on the wireless setup window popping out, and then click “Next”.

The installation program will determine whether wireless network of the printer is to be configured based on your choice in this step;

- if you need to configure or change wireless network of the printer, please select “yes” after the printer connects USB;
- if not, please select “no”.

Yes, I want to configure the printer's wireless network.

No, the printer has been connected to wireless network.

Previous Next Exit

9. The installation software will search the printer automatically and the searching process may need some time.

10. Select the printer needs to be connected and click “Next”.

Detected Printer

Printer Name	IP Address	Host name
<input checked="" type="checkbox"/> X X X Series PCL6 0001	10.10.148.140	X X X -7796BB

Install the printer from the list with a hostname Refresh

Add the IP address or hostname manually

Previous Next Exit

 **Note:**• If the printer you need to connect is not in the list of printers searched, please click “Refresh” to search again.

- When the printer IP address changes under printer driver installed with host ID , you can also directly print without re-installing the driver. If you need to install the printer driver with the host ID, please check the option "Install the printer in the list with host ID".
- If IP address or host name is added manually, you need to know the IP address of the printer connected or host name. If they are not made clear, please print the “NetConf Pg” and view “IP Address” and “Host name” (Please refer to [Chapter 9.4](#)).

11. The software installs the driver automatically and the installation process may need some time. The duration is related to your computer configuration, please wait patiently.

12. After the installation, click "Print & Test Page" button. If your printer prints the test page successfully, it means that you have installed the driver correctly.

3.1.3. Method of driver unistallation

Windows 7 is taken as the example in the following operation. The information on your computer screen may differ because of multiple operating systems.

1. Click the Start menu of computer and then click All programs.
2. Click GG IMAGE, and then Click GG IMAGE XXX Series.

GG IMAGE XXX Series where XXX represents product model.

3. Click uninstall to delete the driver according to instructions on uninstall window.
4. Restart computer after finishing unloading.

3.2. macOS system driver installation

- Driver installation under macOS system is divided into 2 steps, driver installation and adding a printer. If you are going to print in AirPrint mode, there is no need to install a driver and you just need to add a printer directly.
- When you are installing a driver with wired or wireless network, you may need to know the Bonjour name of printer. Please print the "Network setup page" to view it. (Please refer to [Chapter 9.4](#)).

3.2.1. Driver installation

macOS 10.11 is taken as the example in the following operation. The information on your computer screen may differ because of multiple operating systems.

1. Turn the power of printer and computer on.
2. Insert the CD accompanying with printer in the CD driver of your computer, and double click GG IMAGE XXX Series installation package. (XXX in GG IMAGE XXX Series represents product model.)



3. Click "Continue".
4. Read licensing agreement and then click "Continue".

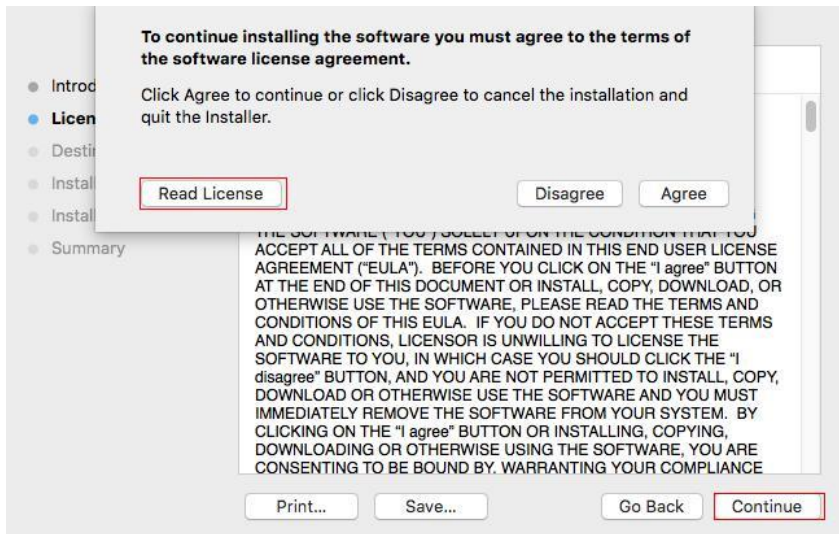

5. Click "Agree" on the prompt window popping out to accept the licensing agreement.
6. Click "Install".
7. Input computer password and click "Install Software".

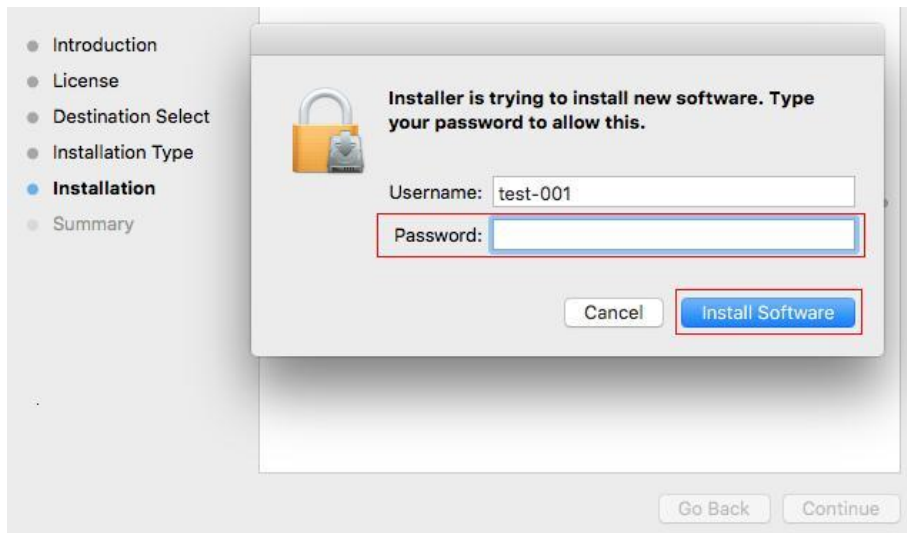

8. Click "Continue Installation" on the prompt window popping out.
 9. The system will finish driver installation automatically.
- If using a USB cable to connect a computer with a Wi-Fi model printer, a wireless network configuration prompt window will pop up during driver installation, as shown in following picture.

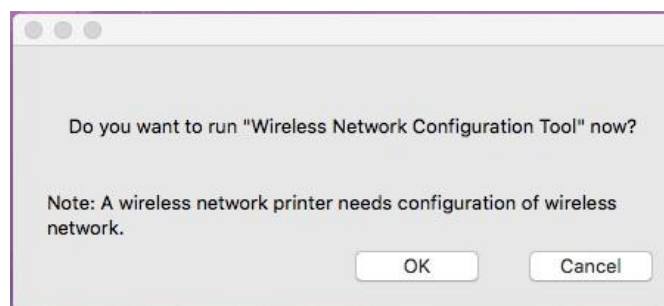



Note: • Click “Yes”, you can configure printer’s wireless network via wireless network configuration tool (refer to [Chapter 5.1.1](#) for how to make configuration).When configuration is completed, unplug USB cable, and then on the pop-up “Add Printer” interface, you may add the network-connected printer(refer to [Chapter 3.3](#) for how to add printer).

• Click “No”, you can add a USB-connected printer on the pop-up “Add Printer” interface (refer to [Chapter 3.3](#) for how to add printer).

If using a USB cable to connect a computer with a non-Wi-Fi model printer, a “Add Printer” interface will pop up during the driver installation and you can add a printer here (refer to [Chapter 3.3](#) for how to add printer).

3.3. Add printer to macOS system

3.3.1. Add up the printer via USB

1. Connect the printer to computer with USB cable and then turn power on.
2. Enter the “System Preferences” – “Printers & Scanners” of computer.
3. Click  button to select “Add Printer or Scanner”.
4. Select printer and then select the corresponding printer mode from the “Use” menu popping out.
5. Click “Add”.

3.3.2. Add up the printer via wireline connection (applicable to wired network models)

1. Turn the power of printer and computer on.
2. Connect the computer to wired network.
3. Connect the network cable to the network interface of printer, and make sure the printer is connected to the computer network (Please refer to [Chapter 4](#) for network setup).
4. Enter the “System Preferences” – “Printers & Scanners” of computer.
5. Click  button to select “Add Printer or Scanner”.
6. Select printer and then select the corresponding printer mode from the “Use” menu popping out.
7. Click “Add”.

3.3.3. Add up the printer via wireless connection(applicable to Wi-Fi models)

1. Turn the power of printer and computer on.
2. Make sure the wireless network connection between computer and printer is set up.



Note: • In case of basic structure mode, connect wireless network printer to the access point (wireless router). Please refer to [Chapter 5.1](#) for connection method.

• In case of Wi-Fi Direct mode, connect wireless client to wireless network printer directly. Please refer to [Chapter 5.2](#) for connection methods.

3. Enter the “System Preferences” – “Printers & Scanners” of computer.
4. Click  button to select “Add Printer or Scanner”.
5. Select printer and then select the corresponding printer mode from the “Use” menu popping out.
6. Click “Add”.

3.3.4. Add AirPrint printer

1. Turn the power of printer and computer on.
2. Make sure the connection between printer and computer is set up (USB connection or network connection).
3. Enter the “System Preferences” – “Printers & Scanners” of computer.
4. Click  button to select “Add Printer or Scanner”.
5. Select printer and select “Secure AirPrint” (data encryption) or “AirPrint” (no encryption) in the “Use” option box.
6. Click “Add”.



- Note:**
- When the printer is connected to computer with USB cable, the system will recognize and add AirPrint automatically.
 - If AirPrint printer of network connection is added, then the connecting USB cable should be disconnected first before adding the printer.
 - AirPrint printer is named after the ending of "AirPrint".
-

4. Wired network setup (applicable to wired network models)

In case printers support wired network printing, they can be connected to network to control printer to print in wired network mode.

4.1. Set IP Address

The IP address of the printer may be automatically obtained through DHCP function or set manually.

4.1.1. Automatic Setting

DHCP automatic setting function is enabled by default on the printer.

1. Connect the printer to the network through a network cable and complete the startup preparation work.
2. The printer will receive the IP address assigned by server automatically. It may take server minutes to receive IP address under the influence of network environment.

You can check the IP address of printer by printing "Network setup page" out (please refer to [Chapter 9.4](#) for printing method) or check network information by viewing the control panel of printer (please refer to [Chapter 9.3](#) for viewing methods). If the IP address is not listed, please check network environment and then try again after waiting for several minutes.



Note: • If DHCP server fails to assign IP address automatically, the printer will get the link-local address assigned by printer automatically: 169.254.xxx.xxx.

4.1.2. Manual Setting

To set up IP address for printer through the control panel of printer manually, please refer to [Chapter 9.2](#) for details.

To set up IP address for printer through the embedded Web server manually, please refer to [Chapter 6.2.1](#) for details.

5. Wireless network setup (applicable to Wi-Fi models)

Wireless network connection type is divided into basic structure mode and Wi-Fi Direct mode. If you have problems with wireless network setup, please refer to [Chapter 5.3](#) Wireless Network Setup FAQs.

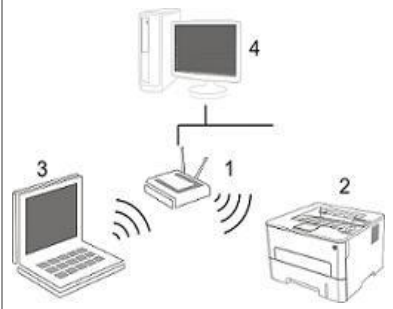
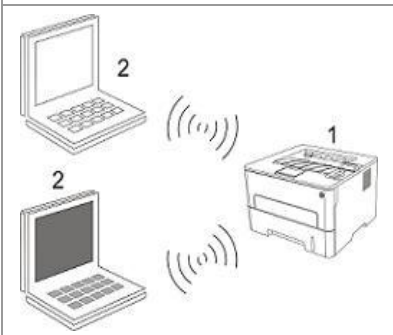
	<p>Basic structure mode: connecting to a wireless device via router</p> <ol style="list-style-type: none">1. Access point (wireless router)2. Wireless network printer3. Computer connecting to access point via wireless network4. Computer connecting to access point via network cable
	<p>Wi-Fi Direct mode: wireless client is connecting to a printer with Wi-Fi function</p> <ol style="list-style-type: none">1. Wireless network printer2. Wireless client is directly connecting to a wireless network printer

5.1. Basic structure mode

You can connect a computer to your printer via access point (wireless router) as the medium. Access point (wireless router) connection is divided into wireless network setup and Wi-Fi Protected Setup (WPS).

Important: Before wireless network installation, you must learn about the service set identifier (SSID) and password of your access point in order to use them during wireless network setup. If they cannot be determined, please consult your network administrator or access point (wireless router) manufacturer.

5.1.1. Wireless network setup tools

If your computer has been installed with a driver and had been connected to wireless network, but the wireless network was changed, you can set it again with wireless network setup tools.

5.1.1.1. Preliminary preparations

1. Access point (wireless router).
2. A computer that has been connected to network.
3. A printer that has wireless network function.

5.1.1.2. Setup methods of wireless network setup tools

1. Take the wireless network setup tool in computer.
 - 1) Windows system: Click the “Start menu” – “All programs” - “GG IMAGE” – Product name – “Wireless network setup tool”.

2) Mac system: click "Go" - "Applications" - "GG IMAGE" - "Utilities" - "Wireless Network Configuration Tool" on the computer Finder menu bar.

2. Use USB cable to connect and configure. Select "Yes, I have a USB cable that can be used for installation" in the following interface. Click "Next".

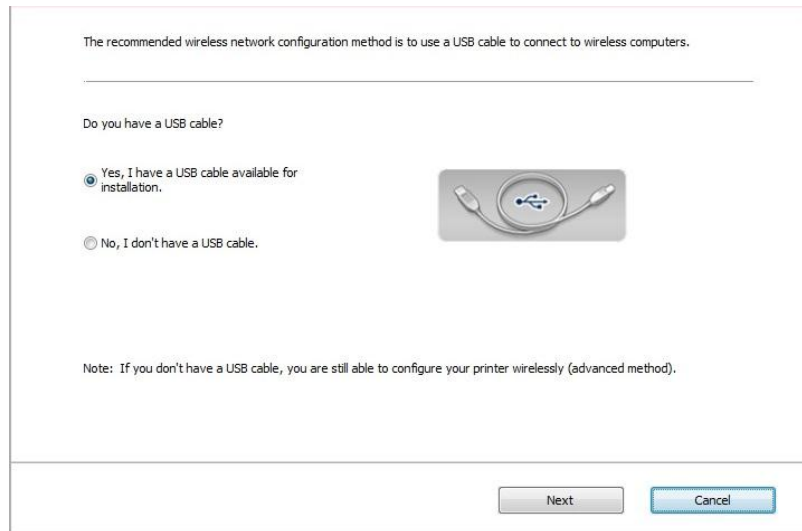

2.1 The computer has been connected to wireless network.

1) The currently wireless network currently connected to computer is selected as wireless network configuration tool by default. Complete configuration according to interface prompt.

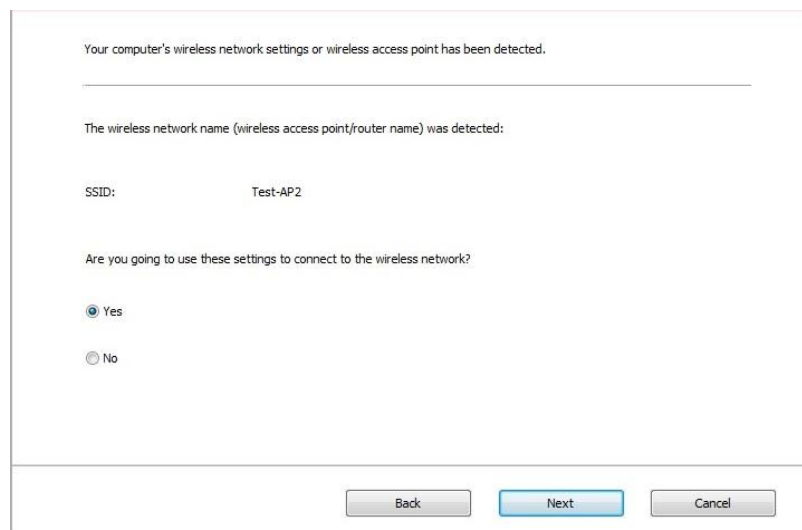

Note: • The SSID you selected should be consistent with the SSID of access point (wireless router) connected to your computer.

2) Please tick “No” to configure other wireless network needed to connect to. Complete configuration according to interface prompt.

Please select the corresponding network name (SSID) from the following list, or manually enter the SSID and password if necessary, and then click "Next" to configure.

Network Name	Encryption method	Signal Strength
Test-AP2	WPA/WPA2	100%
Test-AP3	WPA/WPA2	100%

Refresh

Network Name (SSID):
Test-AP3

Encryption method:
WPA/WPA2

Password:
 Show password

Back Next Cancel



Note: • At present, the printer supports 3 types of safe modes: none, WEP and WPA/WPA2.

1) None: There is no encryption method used.

2) WEP: Send and receive data via security key by using WEP (Wired Equivalent Privacy). WEP key is applicable to 64-digit and 128-digit encrypted network and can contain numbers and letters at the same time.

3) WPA/WPA2: it is the pre-shared key (PSK) of Wi-Fi protected access which connects wireless device and access point via TKIP or AES encryption (WPS-Personal). The working length of WPA/WPA2 is within the PSK of 8-63 characters.

• The display password is not ticked by default; if it is ticked, all passwords input can be seen in clear text.

2.2 The computer is not connected to wireless network Input the SSID (case sensitive) and password of access point (wireless router) in the interface below. Complete configuration according to interface prompt.

1. Please click on "Print wireless network information page" to get the network name and encryption method. Please skip this step if you already know the network name and encryption method.

Printing wireless network information page

2. Please enter wireless network user name and password.

Network Name (SSID):

Encryption method:
None

Back Next Cancel



- Note:**
- If you do not know the SSID of access point (wireless router), please click “Print Wireless Network Information Page” to view the SSID of the needed access point (wireless router).
 - If the printer cannot be used normally after wireless network setup is finished, please install the drive again.

3. Use WPS connection .

Select “No, I don’t have a USB cable” in the interface below and then click “Next”.

The recommended wireless network configuration method is to use a USB cable to connect to wireless computers.

Do you have a USB cable?

Yes, I have a USB cable available for installation.

No, I don't have a USB cable.



Note: If you don't have a USB cable, you are still able to configure your printer wirelessly (advanced method).

Next Cancel

1) Use WPS method to perform steps below to start wireless network on printer. (Please refer to [Chapter 5.1.2](#) for detailed WPS configuration)

Use WPS method to perform steps below to start wireless network on printer.

1. Hold Wi-Fi button on printer for 2s.

2. Set the access point to WPS mode.
For details, see the guide provided with the access point.





3. After all of the above are done, please click "Next".

If you encounter any problems in the configuration process, place the printer closer to the location of the Wireless Access Point for the time being.

Back Next Cancel

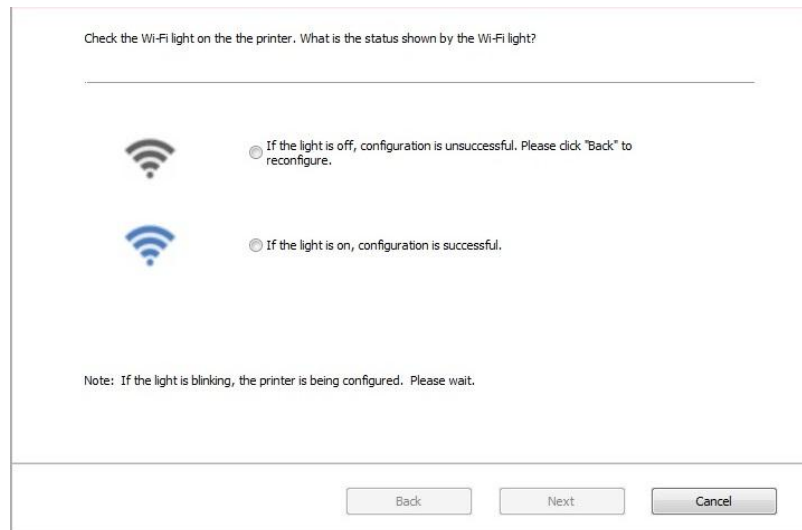
2) Judge if the printer is successfully connected according to the status of Wi-Fi indicator on printer. If configuration failed, please click "Previous" to configure again; if configuration succeeded, please click "Done" to complete configuration.



 **Note:** • If the printer cannot be used normally after wireless network setup is finished, please install the drive again.

5.1.2. Wi-Fi Protected Setup (WPS) setup

If the access point (wireless router) supports Wi-Fi Protected Setup (WPS), the Wi-Fi key on the control panel of printer and WPS key on access point (wireless router) can be pressed in order to connect the printer to wireless network.

5.1.2.1. Preliminary preparations

1. The access point (wireless router) supports Wi-Fi Protected Setup (WPS).
2. A printer that has wireless network function.

5.1.2.2. Wi-Fi Protected Setup (WPS) method

1. Turn on the power of printer and access point (wireless router).
2. Make sure the printer is in ready state.

 **Note:** • If the printer is in sleep mode, it can be woken up by pressing any key on the control panel of printer.

3. Press "Wi-Fi" button on the printer panel for over 2s until the Wi-Fi indicator flashes in blue and then release the button.
4. Press the WPS key on access point (wireless router) within 2min and then release it.
5. When the access point (wireless router) and printer start to connect, the blue Wi-Fi indicator of printer starts to blink. The blue Wi-Fi indicator of printer will be normally on after successful connection.

If the connection is not established after more than 2min, the printer will return to its ready state, the Wi-Fi indicator will be off and Wi-Fi Protected Setup (WPS) connection will fail. If it is needed to connect again, please repeat steps 3-4 above.

 **Note:** • Please refer to [Chapter 1.5](#) for how to cancel and disconnect Wi-Fi connection.
• After successful Wi-Fi Protected Setup (WPS) connection, please install a driver if you want to print via wireless network.

5.1.3. How to disable the Wi-Fi network connected

Connect the wireless network in infrastructure mode by the steps above. If connected, the Wi-Fi light on the control panel is normally on. Press and hold this button for more than 2s to disconnect from Wi-Fi network (Wi-Fi light will be off).

5.2. Wi-Fi Direct mode

You can connect wireless client (including the computer and mobile device with wireless network feature) to wireless network printer without using the access point (wireless router).

5.2.1. Preliminary preparations

1. Printer with the Wi-Fi Direct feature.
2. Wireless client (including computer and mobile device with wireless network feature).

5.2.2. Wi-Fi Direct connection

Before connecting to printer hotspot, turn on direct Wi-Fi connection of the printer by short pressing "Wi-Fi" button on the panel.

 **Note:** • Short press "Wi-Fi" button on the printer panel to automatically print out "Mobile Device Wi-Fi Connection Wizard" page for Wi-Fi connection by mobile devices.

5.2.2.1. Connection method of wireless client that supports Wi-Fi Direct feature (direct invitation to connect)

You must use mobile devices that support Wi-Fi Direct function for Wi-Fi Direct connection. The operating steps may differ because of the mobile device you are using.

1. Turn on printer power.
2. Turn on the mobile device and select setup to enter Wi-Fi connection interface.

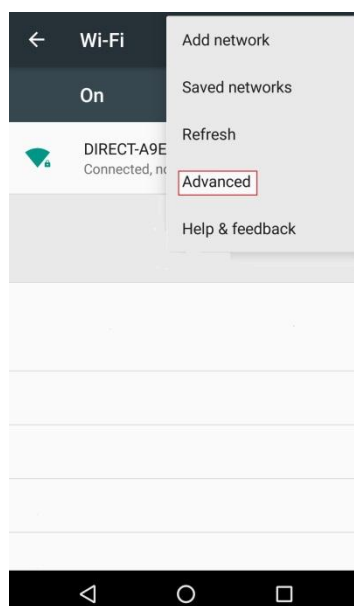

3. Select “Advanced” and then select “Wi-Fi Direct” in advanced WLAN interface.

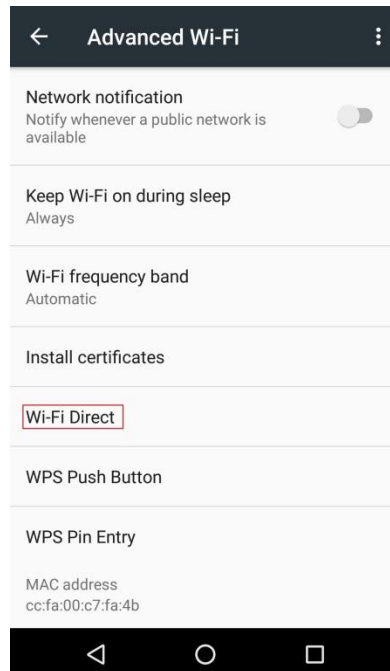

4. Select printer SSID on direct interface to launch a connection invitation.

5. Press “OK key” to confirm connection when the panel lead to prompts whether to connect to start Wi-Fi Direct connection.



Note: • In case of auto connection mode, the mobile device will start to connect automatically after initiating connection invitation without panel confirmation.

5.2.2.2. Connection method of wireless client that does not support Wi-Fi Direct function (input password to connect)

1. Turn on printer power.
2. Press the “Menu key” – “Network Info” – “Wi-Fi dir. Info” on control panel of printer to view “SSID” and “Password”.
3. Turn on the computer or mobile device with wireless network function; select the SSID of Wi-Fi Direct and input password to connect.

5.2.3. How to disable the Wi-Fi Direct

1. Turn on printer power.
2. Press "Menu", "Network Set", "Wi-Fi Direct" and then "Off" on the printer's control panel to disable Wi-Fi Direct.

5.3. Wireless network setup FAQs

1. The printer is not found.

- If the power of computer, access point (wireless router) or printer is turned on.
- If the computer is connected to printer with USB cable.
- If the printer supports wireless network connection.

2. SSID cannot be found when network is connected

- Inspect if the power switch of access point (wireless router) is turned on.
- The printer cannot find the SSID of the access point (wireless router) you need to connect, please check the SSID of access point and try to connect again.
- Every time when the setup of access point (wireless router) is changed, you must set up the wireless network of printer again.

3. Connection failure

- Please inspect if the safe mode and password of access point (wireless router) and printer is correct.
- Inspect the wireless receiving around printer. Signal receiving may be affected if the router is away from the printer or there is an obstacle between them.
- Turn the power of access point (wireless router) and printer off and then restart them and set up.

4. The following aspects should be inspected if the printer has problems while they are used in network:

- Inspect if the firewall software blocks communication. If the computer and printer are connected in the same network but they cannot be searched, the communication might be blocked by firewall software. Please refer to the user guide of firewall software to turn firewall off and then try to search the printer again.

- Inspect if the IP address assignment of printer is correct. You can inspect IP address by printing the network setup information page of printer out.

- Please refer to the following steps to check if printer and computer are in the same network:

1) Select "Command prompt" as shown below.

a. Windows 8/10 system: Select "Search" button in the Start Menu and input "Command prompt" in search bar, then press the "Enter" button in the keyboard.

b. Windows 7/Vista/XP system: click "Start" menu-"All procedures"-"Attachment"-"Command prompt".

2) Input ping and your printer IP address in popup window, and press "Enter" button.

For example: ping XXX.XXX.XXX.XXX("XXX.XXX.XXX.XXX" is printer IP address)

3) If RTT is indicated in the window, that is to say your printer and computer are in the same network. If RTT is not indicated in the window, please refer to [Chapter 5](#) to re-configure the printer wireless network.

 **Note:** • Please refer to the user guide or consult the manufacturer for information related to access point (wireless router).

6. Web server

You can manage printer setup via the embedded Web server.



Note: • Some functions are not available depending on different printer models. If you have any questions, please contact the Customer Service.

6.1. Visit the embedded Web server

1. Turn on the power of printer and computer.
2. Connect the printer to network to ensure that the printer is connected to the network where the computer is connected to (please refer to [Chapter 4](#) or [Chapter 5](#) for network setup method).
3. Input the IP address of printer in the address bar of Web browser to visit the Web server imbedded in printer.

View the IP address of printer via control panel (please refer to [Chapter 9.3](#)) or print the “Network setup page” out to view the IP Address of printer (please refer to [Chapter 9.4](#)).



Note: • Windows users are suggested to use Microsoft Internet Explorer 8.0 (or higher version) or Firefox 1.0 (or higher version), Mac users are suggested to use Safari 4.0 (or higher version). No matter what kind of browser you are suing, please ensure that JavaScript and Cookies are always enabled. Please ensure compatibility with HTTP 1.0 and HTTP 1.1 when other network browsers are used.

- If the computer cannot visit the Web server embedded in printer, then your computer and printer may be connected to different networks. Please inspect your network environment or consult your network administrator.

4. Click “Log in” option, input user name and password (the default user name is admin and the initial password is 000000) and click “Log in”.



Note: • For safety reasons, you are suggested to change the default password, which can be finished in the “User Management” interface.

6.2. Use Web server to manage printer

You can use the embedded Web server to manage printer.

1. View the basic information including product name, printer state and ink cartridge of printer.
2. Set up the network protocol parameters supported by printer.
3. Set up the wireless network connection of printer, and turn on/off wireless network and Wi-Fi Direct function.
4. Set up mail server client and acquire printer state via E-mail notification.

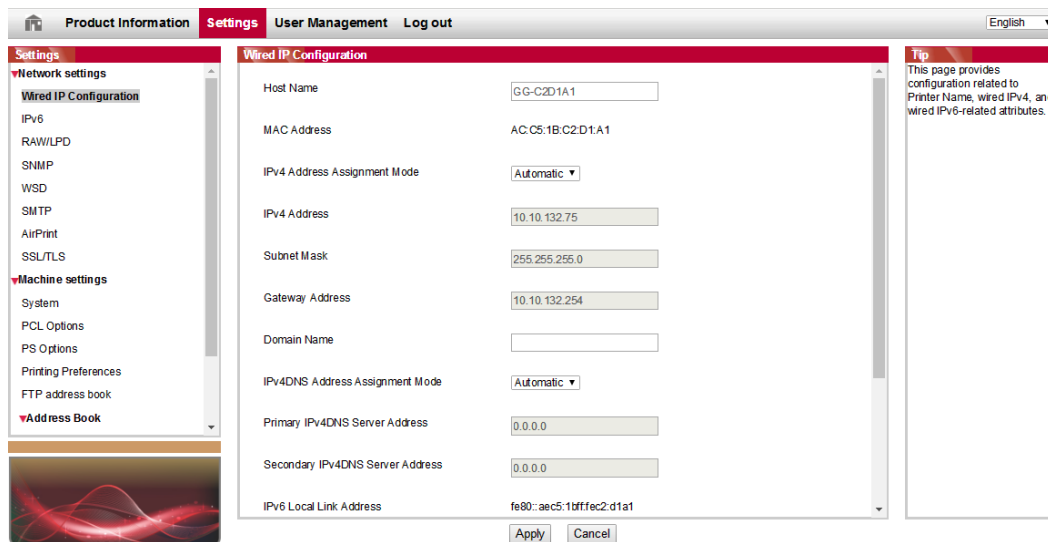

6.2.1. IP address setup

You need to connect your printer to network before IP address setup.

1. In case of wired network model, connect the printer to wired network by connecting to its network interface with network cable.
2. In case of wireless network model, the printer can be connected to wireless network via wireless network setup tools or Wi-Fi Protected Setup(WPS) (please refer to [Chapter 5.1.2](#)).

6.2.1.1. IPv4 setup

IPv4 address of the printer is divided into DHCP auto assignment and manual setting, and the DHCP auto assignment function is on by default. You can set up the IPv4 address of printer manually to set up fixed IPv4 address for the printer.

1. Turn on printer power to connect printer to network.
2. Log in the embedded Web server (please refer to [Chapter 6.1](#) for login method).
3. Click “Settings” – “Network settings” – “Protocol Settings” – “Wired IP Configuration”.
4. Set the IPv4 address assignment mode as “Manual”.
5. Input “IPv4 Address”, “Subnet Mask” and “Gateway Address”, and then click “Apply”.

6.2.1.2. IPv6 setup

1. Turn on printer power to connect printer to network.
2. Log in the embedded Web server (please refer to [Chapter 6.1](#) for login method).
3. Click “Settings” – “Network settings” – “Protocol Settings” – “IPv6”.
4. Tick “Enable IPv6 protocol” and “Enable DHCPv6” (ticked by default) and then click “Apply”.

You can refresh the browser and view the “IPv6 Local Link Address” and “Stateful Address” in “Wired IP Configuration” interface.



Note: The printer supports using the following IPv6 addresses for network printing and management.

- IPv6 local-link address: local IPv6 address set up by oneself (addresses beginning with FE80).
 - Stateful address: IPv6 address set up by DHCPv6 server (if there is no DHCPv6 server in network, the “Stateful Address” cannot be assigned).
 - Stateless address: IPv6 address set up by network router automatically (please refer to [Chapter 9.4](#) and print “Network setup page” view IPv6 address).
-

6.2.2. Wireless setup

You can set up the wireless network, wireless IP setup, Wi-Fi Direct and WPS via wireless setup page. Before setup, please log in the embedded Web server (please refer to [Chapter 6.1](#) for login method).

6.2.2.1. Wireless network

1. Click “Settings” – “Network settings” – “Wireless setup” – “Wireless Network”.
 - 1) If you need to set up wireless network, please click the SSID of access point (wireless router) in search list, input secret key and click “Apply”.

6.2.2.2. Wireless IP setup

Only when the wireless network of printer is turned on, the Wireless IP Configuration can be displayed on Web server.

1. Click “Settings” – “Network settings” – “Wireless setup” – “Wireless IP Configuration”.
 - 1) DHCPv4 is ticked by default. If IP address needs to be set up manually, please cancel the DHCPv4 checkbox ticked and input the “IPv4 Address”, “Subnet Mask” and “Gateway Address” that you need to set up and then click “Apply”.

6.2.2.3. WPS setup

1. Click “Settings” – “Network settings” – “Wireless setup” – “WPS”.
 - 1) Select the “WPS Startup Method” you need, and then click “Apply” and operate according to page prompt.

6.2.2.4. Wi-Fi Direct setup

1. Click “Settings” – “Network settings” – “Wireless setup” – “Wi-Fi Direct”.

6.2.3. Machine setup

You can add mail address contacts, set up e-mail notification, set up sleep time and recover factory settings via machine setup page.

6.2.3.1. Set up e-mail notification

If you set up e-mail notification, an e-mail will be sent to the mail address specified by you when abnormality such as paper out occurs. You can receive emails only if you made correct email setup. Please consult your network administrator for detailed setup steps. You need to log in the

embedded Web server before setting up email notification (please refer to [Chapter 6.1](#) for login method).

I. Set up SMTP client

1. Click “Settings” – “Network settings” – “Protocol Settings” – “SMTP”.
2. On SMTP page, input SMTP server address, set up the mailbox login name and password and then click “Apply”.

II. Add recipient address

1. Click “Settings” – “Machine settings” – “Address Book” .
2. Click “Add”, input recipient address and then click “Apply”.

III. Set up email notification

1. Click “Settings” – “Machine settings” – “E-mail Notification”.
2. Click  button and select the email addresses you want to add in the list of contacts popping out.

You can also tick “address X” (such as address 1) and input the email addresses you want to add.

3. Tick the email addresses and notification contents you want to notify and then click “Apply”.

6.2.3.2. Sleep time setup

1. Log in the embedded Web server (please refer to [Chapter 6.1](#) for login method).
2. Click “Settings” – “Machine settings” – “System”.
3. Select sleep time according to you need and then click “Apply”.

6.2.4. Recover factory settings via Web server

1. Log in the embedded Web server (please refer to [Chapter 6.1](#) for login method).
2. Click “User Management” and then click “Restore to Factory Settings” to recover factory settings. The printer will restart automatically after factory settings recovery is finished.









Note: • After factory settings of printer are recovered, user name of the administrator will be recovered to admin and the login password will be recovered to 000000.
• You can also recover factory settings via keys on the control panel of printer, please refer to [Chapter 9.1.5](#).

7. Print

7.1. Print Function

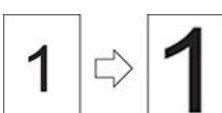
You can set the print function through "Start"->"Devices and Printers"- select corresponding printer- right click – set print function in "Printing preferences". Some functions are as follows:

Functions	Diagram
Automatic Two-Sided Printing	
Collate Print	
Reverse Print	
N-in-1	
Poster Print(for Windows Operation System only)	
Zoom Print	
Custom Size	

-  **Note:** • Windows 7 is taken as example in the above description.
- You can realize poster printing feature by selecting 2x2 poster printing in multipage.
 - You can enable printing preference and click the help button to view detailed function description. Please refer to [Chapter 7.9](#) for the method to open help document.

7.2. Print Settings

You can set up printing parameters with the following two methods before sending printing work (such as paper type, paper size and paper source).

Operating system	Temporary printing setup change	Permanent default setup change
Windows 7	1. Click "File" menu – "Print" – "Select printer" - "Printer properties" (the detailed steps may differ because of multiple operating systems).	1. Click "Start" menu- "Control Panel" – "Devices and Printers". 2. Right click on the printer icon, select "Printing preference" and then change setup and save it.
macOS	1. Click "File" menu – "Print". 2. Change setup in the window popping out.	1. Click "File" menu – "Print". 2. Change setup in the window popping out and click to save the preset. (Select preset every time before printing, or print according to default setup.)

7.3. Cancel printing

The current printing work can be cancelled in printing process. As for printers with LCD control panel, the current printing work can be cancelled by pressing "Cancel"; as for printers with LED control panel, the current printing work can be cancelled by pressing the "Cancel" key for more than 2s.

7.4. Printing Mode

The printer can print with auto feed tray and manual feed tray. The defaulted state is auto selection, and if there is printing medium in the manual feed box, papers in manual feed tray will be used with priority.

7.4.1. Printing with the Automatic Feeder Tray

Before printing, please make sure mediums of corresponding quantity have been installed inside the auto feed tray, and there is no printing medium in the manual feed tray.

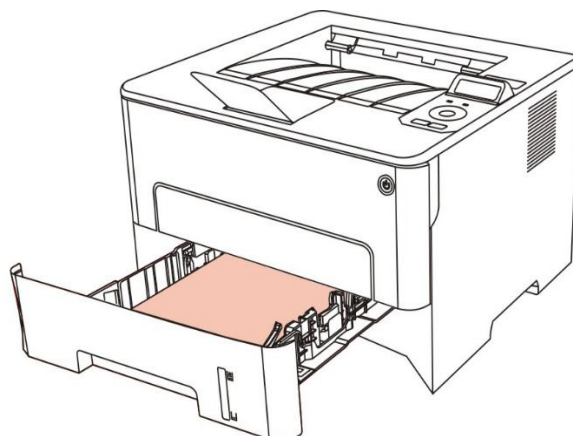



- Note:**
- For precautions on loading paper, see [Chapter 2](#).
 - For the type of media to be printed with the automatic feeder tray, see [Chapter 2.1](#).
-

7.4.2. Printing with manual feed tray

When you put papers in the manual feed tray, the printer will enter manual feed mode.

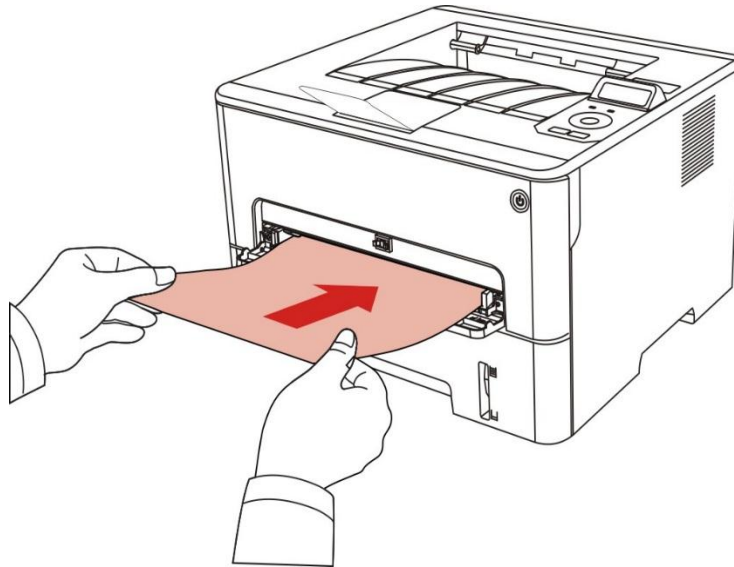

- Note:**
- Manual feed mode means that papers will be fed from the manual feed tray first if there are papers being put inside it.
 - Generally, the manual feeder tray is used to print on special paper, such as envelopes, transparencies, etc., and only one piece of paper can be loaded each time.
 - Please refer to [Chapter 2](#) for putting papers inside manual feed tray.
 - Please refer to [Chapter 2.1](#) for type of mediums that can be printed via manual feed tray.
-

7.5. Automatic Two-Sided Printing

The printer supports automatic two-sided printing of plain paper. Paper size supported by the automatic two-sided printing: A4, Letter, Legal, Oficio, Folio, 16K.



- Note:**
- Trying the automatic two-sided printing may damage the printer if some paper media are not suitable for automatic two-sided printing.
 - Auto duplex printing does not support poster printing.
 - Please refer to [Chapter 2](#) for paper loading and type of mediums that can be printed via auto feed tray.
-

7.5.1. Duplex printing unit setup

For the purpose of achieving the best printing result, you can set up the paper size of duplex printing unit. As for duplex printing of A4 and 16K papers, the slide should be adjusted to the A4 position; as for Letter, Legal, Folio and Oficio duplex printing, the slide should be adjusted to the Letter position.

Setup steps of duplex unit are:

1. Draw out duplex unit.

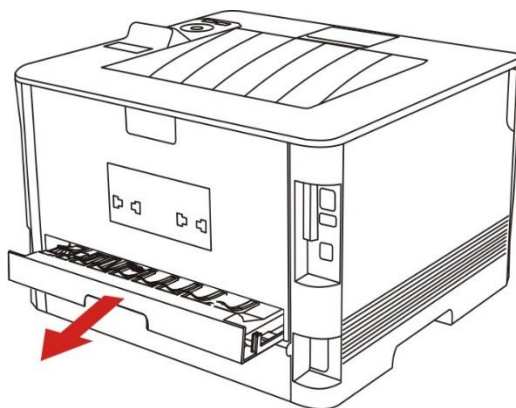

2. Make the backside of duplex unit up.

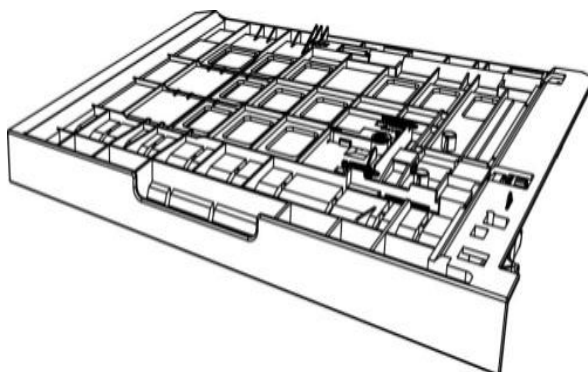

3. Adjust paper size slide to A4 or Letter position to finish setting up.

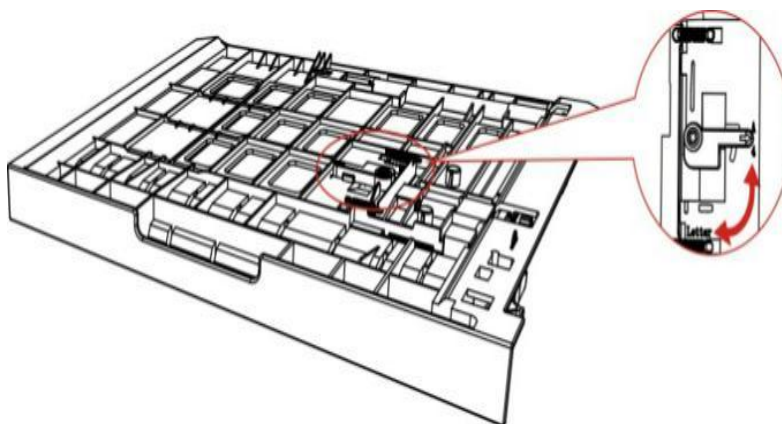

4. Install the duplex unit in the printer.

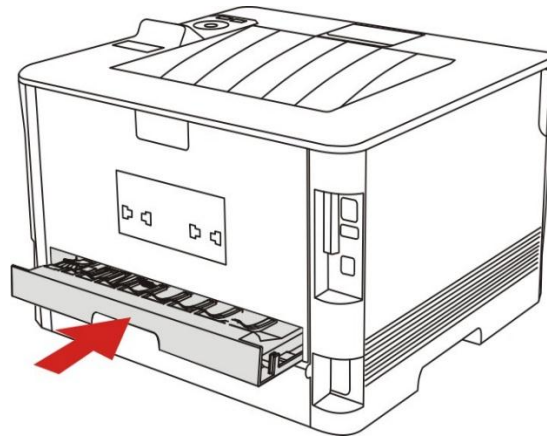

7.5.2. How to carry out auto duplex printing

1. Open the print job to be printed from the application (such as a Notepad).
2. Select Print from the File menu.

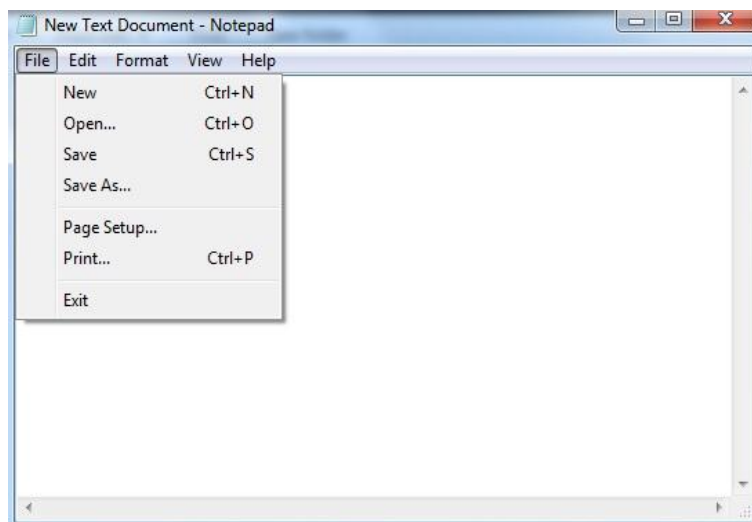

3. Select printer of the corresponding model.

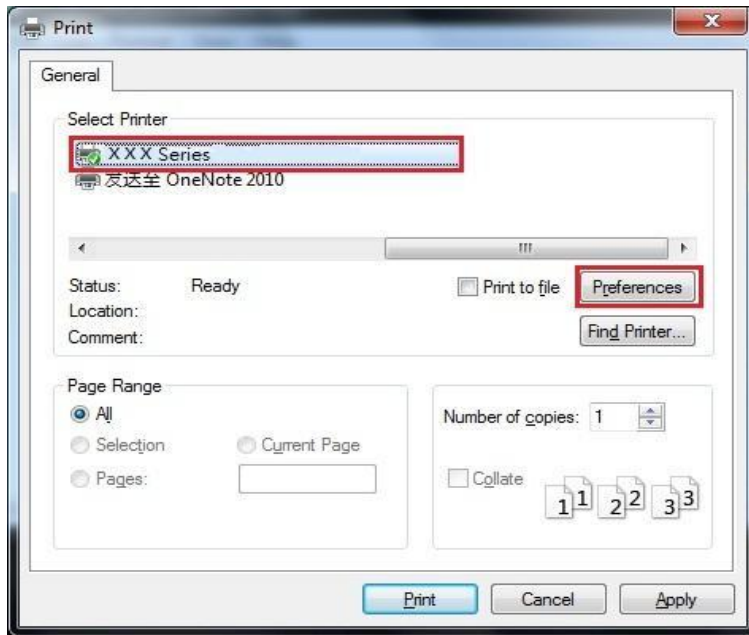

4. Single click “Preferences” for printing setup.

5. Select the “Duplex” in “Basic” tab and then select “Long Edge” or “Short Edge”.

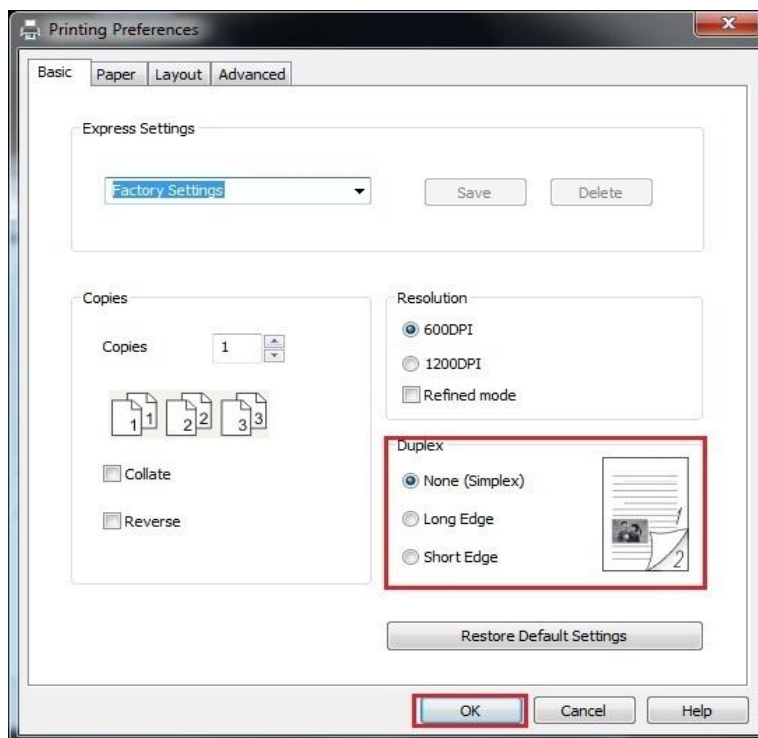

6. Single click “OK” to finish printing setup. Click “Print” to realize auto duplex printing.

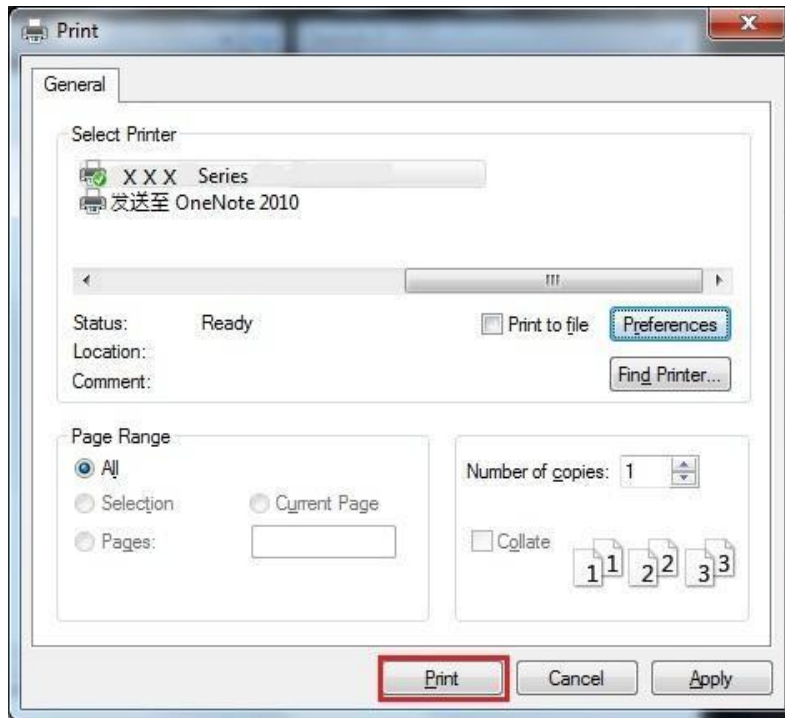

7.6. Fine mode printing

The Fine mode is applicable to engineering drawings and fine lines printing.

Set up fine mode in the basic page of printer preference After setup, fine printing mode can be realized.

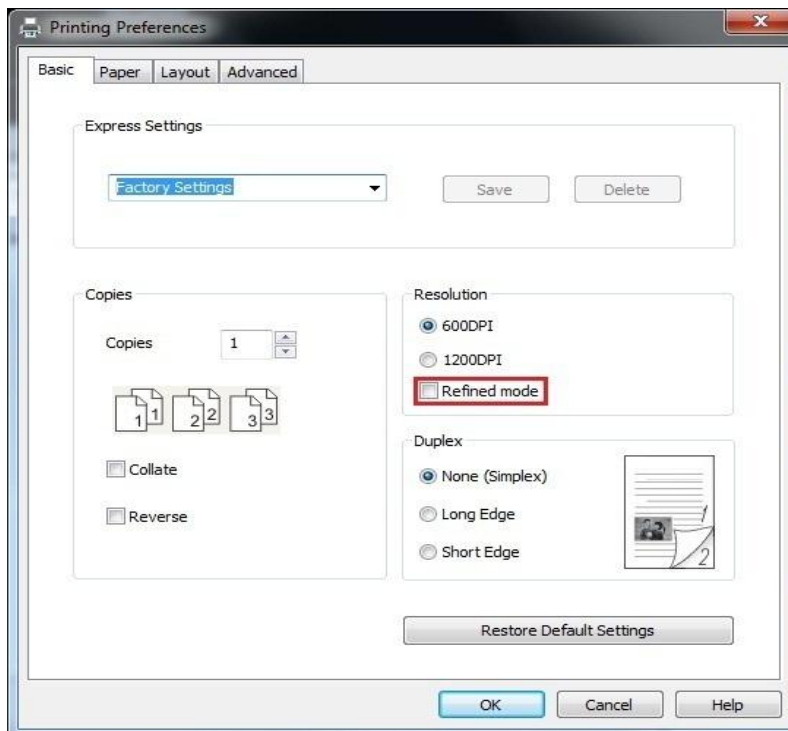

7.7. Mute printing

If the Mute Printing is set, the printing noise will be reduced but the printing will slow down to some extent.

The operating steps of mute printing are as follows (applicable to printers that are installed via USB connection)

Windows 7 is taken as the example in the following operation. The information on your computer screen may differ because of multiple operating systems.

1. Enter the “Start menu” – “Control Panel” –view “Devices and Printers”.
2. Right click printer and select “Printer properties” in the pull-down menu.
3. Enter the “Secondary Settings” option.
4. Tick “Mute printing” and click “Ok” to finish setup.

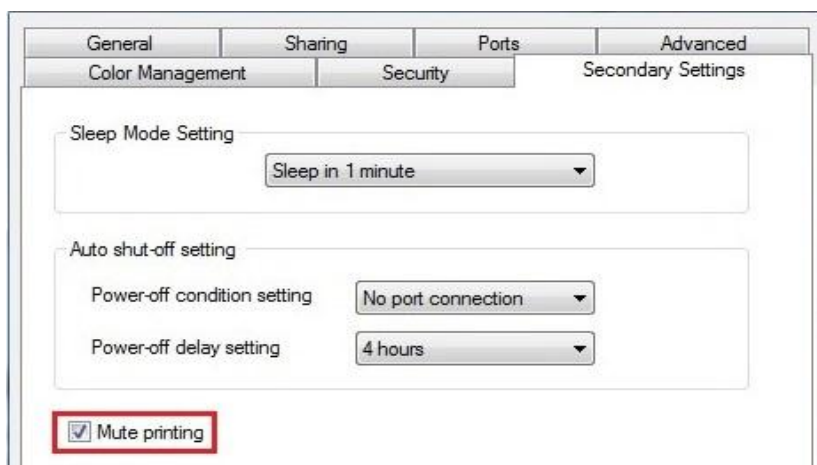

5. Open the printing work from the App, select a printer of the corresponding model and then set up printing according to needs.
6. Click “Print” to realize mute printing.



Note: • Printers with LCD control panel can be set to mute printing with keys on control panel directly, please refer to [Chapter 9.1.4](#).

7.8. Auto shut-off setting

“Auto shut-off setting” to set off condition and off delay of printer.

1. Enter computer “Start Menu” – “Control Panel” – View “Devices and Printers”.
2. Right click printer, select “Printer properties” in drop-down list.
3. Enter “Secondary Settings” option and set “Auto shut-off setting”.
4. Click “OK” to finish setting.

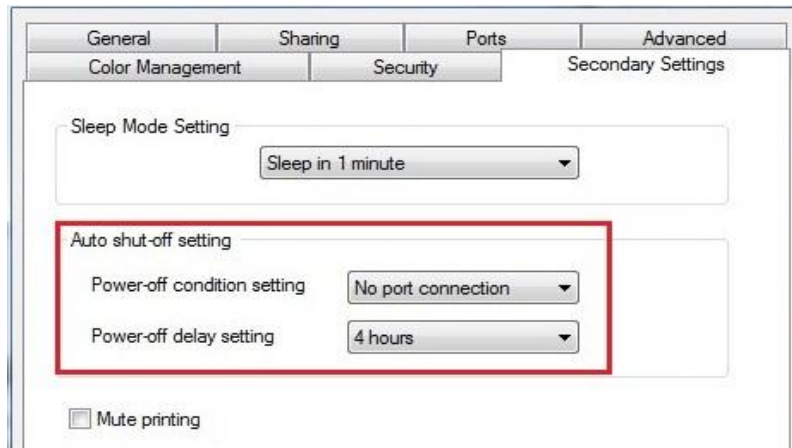

-
- Note:**
- For printer provided with LCD control panel, users may set auto off function through control panel keys. Please refer to [Chapter 9.1.7](#).
 - Individual countries (or regions) do not support auto off setting.
-

7.9. Open Help Document

You can open the "Printing preferences" and click "Help" button (for Windows Operation System only). The help document contains the user guide where you can find the information on print settings.

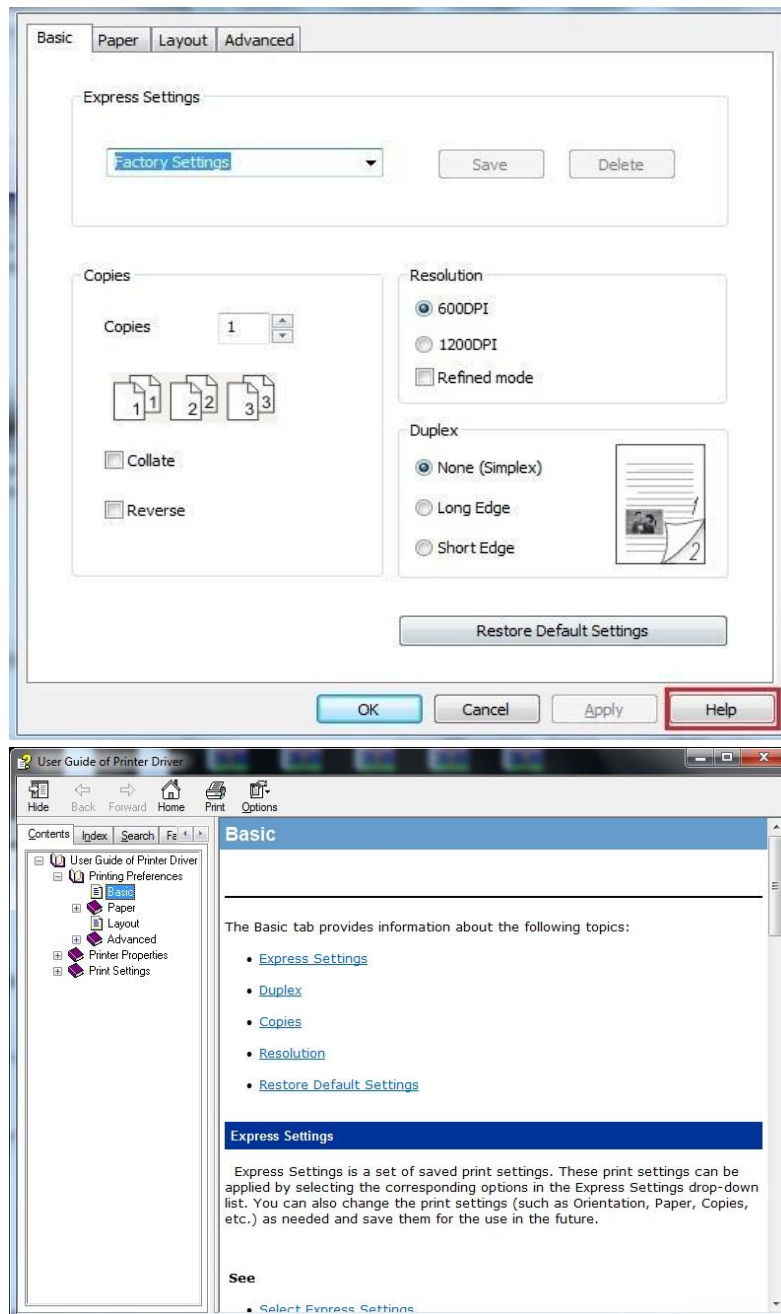

8. Mobile Print



Note: • Some functions are not available depending on different printer models. If you have any questions, please contact the Customer Service.

8.1 AirPrint mobile print

Only printers that support AirPrint function can realize AirPrint printing. Please check if there is AirPrint mark on the packaging of the printer, in order to identify if the printer supports AirPrint function.

8.1.1 Operating systems supported by AirPrint mobile print

Applicable to iOS 7.0 or higher versions.

8.1.2 Preliminary preparations

1. A printer that has wireless network function.
2. iOS mobile device.

8.1.3 How to use AirPrint mobile printing

The printing steps may varied by applications, taking PDF as an example for explanation.

1. Turn on printer power.
2. Connect the iOS mobile device with wireless network of the printer (Please refer to [Chapter 5](#) for how to connect).
3. Open the files you need to print in the format of PDF on the iOS device.

4. Click .

5. Tap "Print".

6. Please make sure the GG IMAGE printer is selected.

If you select other printers (or no printer), please click printer option and then select your GG IMAGE printer.

7. Set printing parameters such as number of copies to print.

8. Tap "Print".



Note: • If printing fails, please inspect if the iOS device is connected to the wireless network where the printer is connected to.
• If the iOS mobile device did not detect any printer, check whether the printer is powered on and the printer is turned on.

9. General Settings



Note: • Some functions are not available depending on different printer models. If you have any questions, please contact the Customer Service.

This Chapter mainly introduces some general settings.

9.1. System Setting

9.1.1. Language Setting

"Language Setting" is used to select the language to be displayed on the control panel.

1. Press "Menu" to enter the Menu Settings interface.
2. Press "OK" to select the "System Setting" option.



3. Press "OK" key to select "Language Set" option to set language, as shown in the below figure:



9.1.2. Sleep Time Setting

Sleep mode can reduce the energy consumption of printer effectively, and "Sleep time setting" can be made in the idle time before the device enters sleep mode.

1. Press "Menu" to enter the Menu Settings interface.
2. Press "OK" to select the "System Setting" option.
3. Press direction key "▲" or "▼" to select "Sleep time Set" option, and press "OK" key to set the corresponding sleep time.



-
- Note:**
- In sleep mode, the printer can be woken up by pressing any key or sending printing work.
 - Sleep time of network printer can be set with the embedded Web server (Please refer to [Chapter 6.2.3.2](#)).
-

9.1.3. Toner Save

You can select the save toner mode which can reduce toner consumption and reduce printing cost. When save toner mode is “on”, the printed color will be lighter. Save toner mode is “off” by default.

1. Press "Menu" to enter the Menu Settings interface.
2. Press "OK" to select the "System Setting" option.
3. Press direction key “▲” or “▼” and select “Toner Save ” option and press “OK” key to turn on/off this mode.

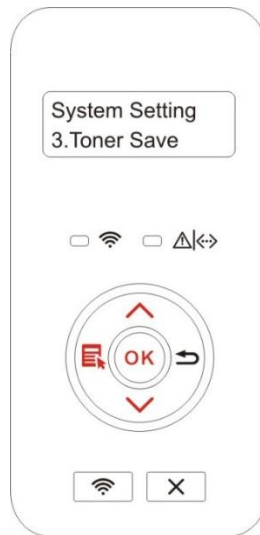

9.1.4. Mute printing

Set mute mode to realize low speed printing with low noise. When mute mode is “on”, printing will be in a low speed. This mode is “off” by default.

1. Press "Menu" to enter the Menu Settings interface.
2. Press "OK" to select the "System Setting" option.
3. Press direction key “▲” or “▼” and select “Mute printing” option and press “OK” key to turn on/off this mode.



9.1.5. Restore Factory Settings

"Restore factory settings" is used to recover the default settings of printer. The printer will restart itself automatically after recovering factory settings.

1. Press "Menu" to enter the Menu Settings interface.
2. Press "OK" to select the "System Setting" option.
3. Press direction key "▲" or "▼" to select the "Restore Set" option and press "OK".



-
- Note:** • Factory settings of network printer can be recovered via embedded Web server (please refer to [Chapter 6.2.4](#)) .
- As for printers with LED control panel, press the power key to turn printer on and then press the Cancel/Continue key for more than 2s until the two green status lights on the panel start to blink at the same time. Then, release the key and wait for factory settings of the printer to recover. The printer will restart itself automatically after finishing recovering factory settings.
-

9.1.6. Print a Page for Clean & Fix

"Print a Page for Clean & Fix"function can clean the toner, paper powder and other impurities, so as to realize better printing effect.The printer will start up Print a Page for Clean & Fix function automatically after the printer has printed a certain number of pages. You can also launch Print a Page for Clean & Fix function manually by setting up the printer panel. The steps are as follows:

1. Press "Menu" to enter the Menu Settings interface.
2. Press "OK" to select the "System Setting" option.
3. Press "▲" or "▼" and select "Clean & Fix" option, then press "OK" to start cleaning and fixing of the fuser unit.



-
- Note:** • For printers having LED control panels, double click "Cancel/Continue" button on the panel to start up cleaning and fixing of the fuser unit.
-

9.1.7. Auto shut-off setting

“Auto shut-off setting” to set off condition and off delay of printer.

1. Press "Menu" to enter the Menu Settings interface.
2. Press "OK" to select the "System Setting" option.
3. Press direction key “▲” or “▼” to select options of “Auto off set”, press “OK” to set off condition and off delay.



 **Note:** Set auto off condition:

- Shutdown under no-port state (default configuration. : no port is connected, Wi-Fi function deactivated, printer is under standby or sleep mode.
 - Shutdown under idle state: the printer is under standby or sleep mode.
 - If auto off condition is satisfied, printer will be off at the preset time.
 - After printer is off, power consumption is 0.5W or lower.
 - Individual countries (or regions) do not support auto off setting.
-

9.2. Network Settings

You can check or set network status via network setting.

1. Press "Menu" to enter the Menu Settings interface.
2. Press direction key "▲" or "▼" and select "Network Set" option and press "OK" key to set "Wired network setting", "wireless network setting" and "Wi-Fi Direct".

 **Note:** • To set IP address, subnet mask and gateway, press direction key "▲" to circularly accumulate values from "0-9", press direction key "▼" to circularly input the position from left to right, press "OK" key to save setting and press "Return" key to return to the previous menu.

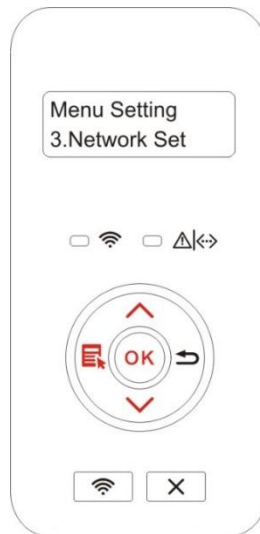

9.3. Network Information

You can check the network status through Network Information..

1. Press "Menu" to enter the Menu Settings interface.
2. Press direction key "▲" or "▼" and select "Network Info" option and press "OK" key to view "wired network information", "wireless network information" and "Wi-Fi Direct information".



9.4. Print information report

You can print information report by operating control panel. These pages can help you to learn about product information, and diagnose and solve product failures.

1. Press "Menu" to enter the Menu Settings interface.
2. Press direction key "▲" or "▼" and select "Prt Info Rept" option.



3. Press "OK" key to enter information report print. You can print product report according to needs.

Product reports that can be printed include demonstration page, information page, menu structure page, network setup page, Wi-Fi hotspot list page, PCL font list page and PS font list page.



Note: • The product report above is the most complete version, and may be different from the product report of model that you actually use.

10. Routine Maintenance

 **Note:** • Printer appearance may differ because of different models and functions, so the schematic diagram is only for your reference.

10.1. Cleaning the Printer

 **Note:** • Please use mild detergents.

- Some parts of the printer may still be hot for a short period after use. When opening the front cover or rear cover to clean the parts inside the printer, please do not touch the parts in the shaded area as shown in the following picture.

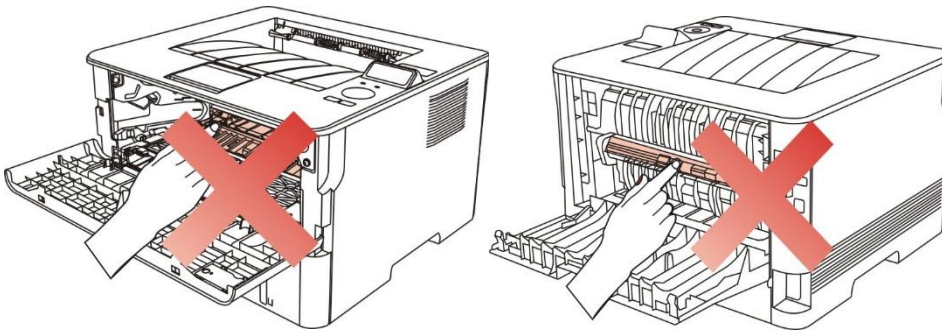

1. Use a soft cloth to wipe the outside of the printer clean.

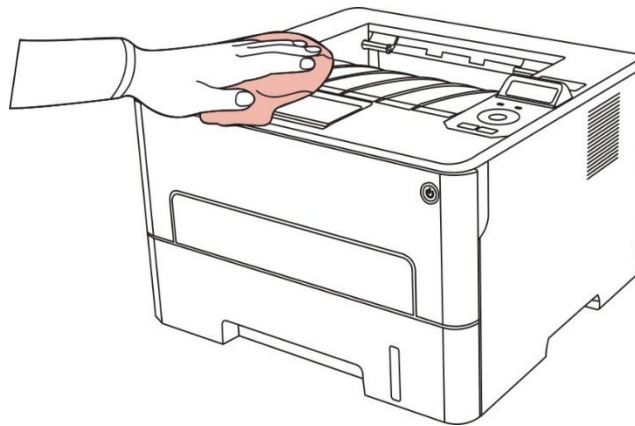

2. Open the front cover and take the laser toner cartridge out along the track.

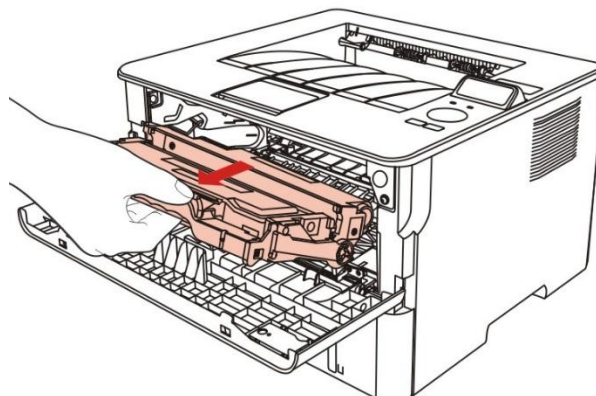

 **Note:** • When removing the toner cartridge, put the toner cartridge in a protective bag or wrap it with thick paper to avoid direct light damaging the toner cartridge.

3. Clean the inside of the printer by gently wiping the shaded area, as shown in picture, with a dry and lint-free cloth.

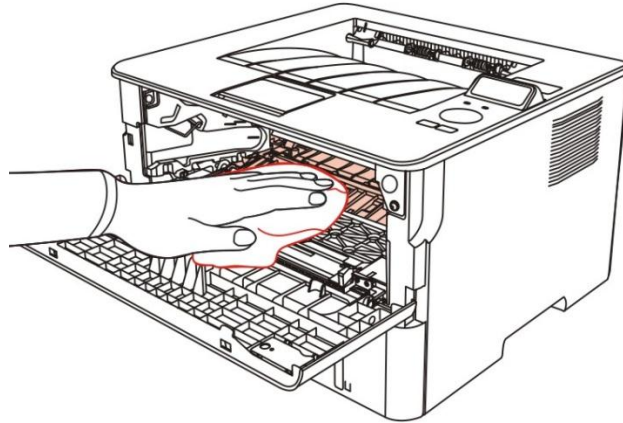

4. Wipe the LSU lens of printer gently with dry lint cloth.

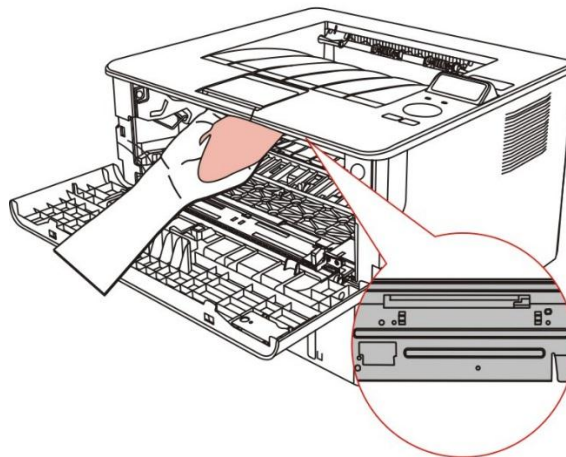

5. Open the auto feed tray and wipe the pickup roller gently with dry lint cloth.

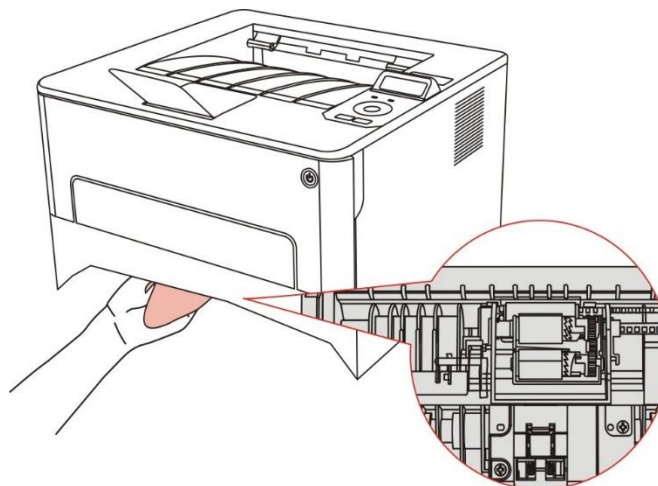

10.2. Toner cartridge and drum component component maintenance

10.2.1. About toner cartridge and drum component component

1. Application and maintenance of toner cartridge

Please use the original toner cartridge for better printing quality.

Please pay attention to the following items while using the toner cartridge:

- Do not take the toner cartridge out of its package unless it will be used immediately.
- Do not refill the toner cartridge without permission; otherwise, the damages caused will not be included in the scope of warranty of the printer.
- Please place the toner cartridge in cool and dry places.
- Please do not place the toner cartridge near ignition sources, as the toner inside it is inflammable and may cause fire.
- Please pay attention to toner leakage while it is taking out or disassembled. In case of toner leakage, skin contact with toner or spattering into eyes or mouth, please wash it with clear water immediately, or see a doctor if feeling unwell.
- Toner cartridge should be placed out of reach of children.

2. Service life of toner cartridge

- The service life of toner cartridge is depending on the toner quantity needed by printing.
- For printers with LED control panel, normally-on orange toner cartridge indicator means that the service life of toner cartridge has expired and a new toner cartridge should be replaced to.
- For printers with LCD control panel, normally-on orange toner cartridge indicator or “Ctg life expired” displayed on LCD display means that the service life of toner cartridge has expired and a new toner cartridge should be replaced to.

3. Service life of drum component

- For printers with LED control panel, normally-on red drum component indicator means that the service life of drum component has expired and a new drum component should be replaced to.
- For printers with LCD control panel, “DrumUnitLifeEnd” displayed on LCD display means that the service life of drum component has expired and a new drum component should be replaced to.

10.2.2. Replace toner cartridge and drum component



Note: Please pay attention to the following matters before replacing toner cartridge:

- Since there may be toner on the surface of toner cartridge, please pay attention while taking it out to avoid spattering.
- Please place the toner cartridge taken out on paper to avoid large-scale spattering of toner.
- When installing, do not touch the surface of the toner cartridge, so as to avoid scratching it.

Toner cartridge replacement steps:

1. Power off the printer.

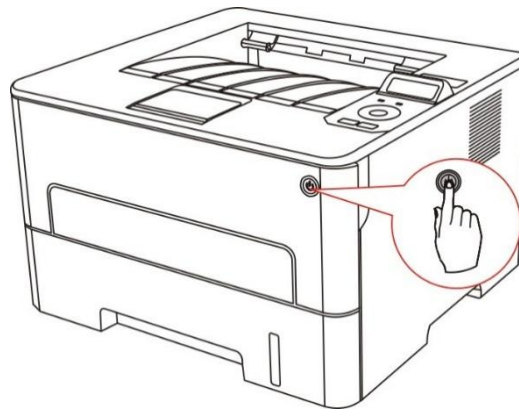

2. Open the front cover and take the laser toner cartridge out along the track.

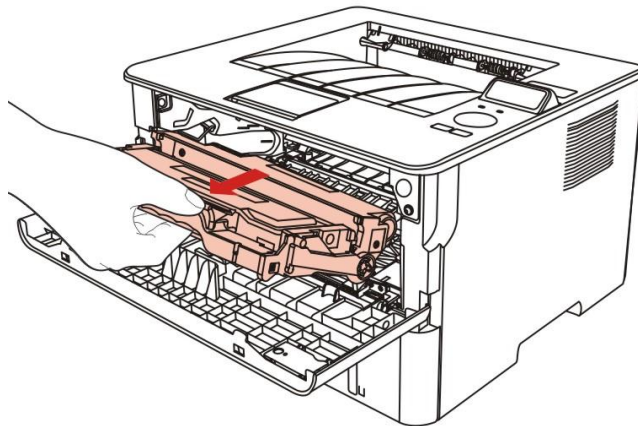

3. Press the blue button on the left side of drum component with left hand and lift the toner cartridge handle with right hand at the same time to take the toner cartridge out.

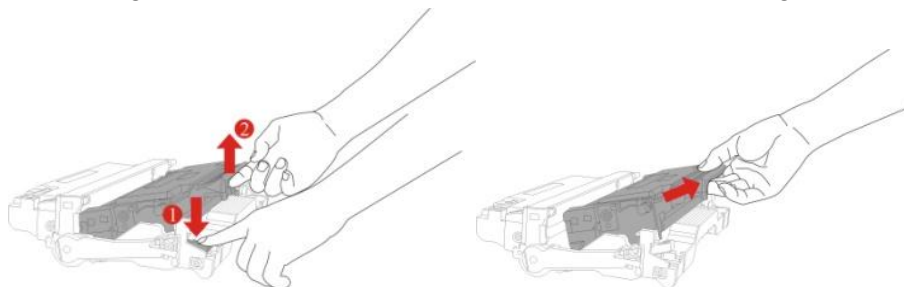

4. Open the package of the new toner cartridge and hold the toner cartridge handle to shake it left and right for 5 – 6 times, so that the toner inside can be uniformly dispersed.

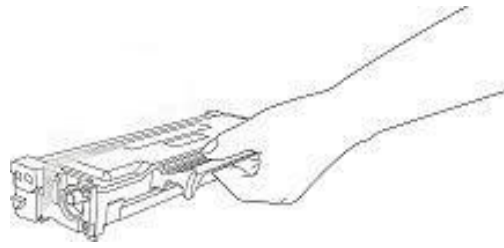

5. Pull the seal out and take the toner protection cover out.

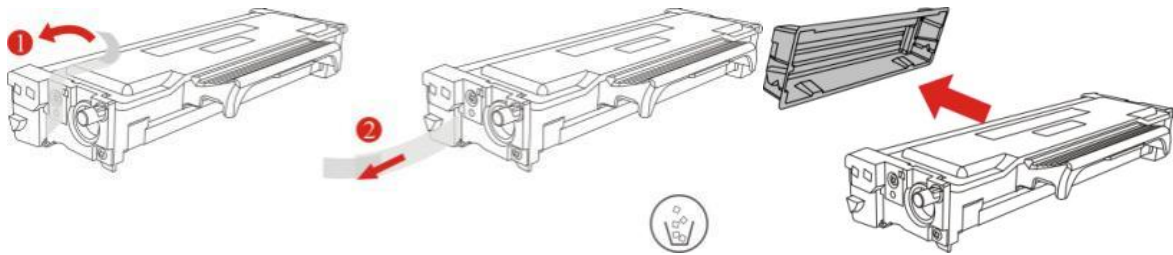

6. Install the drum component along the inner track to finish installing toner cartridge.

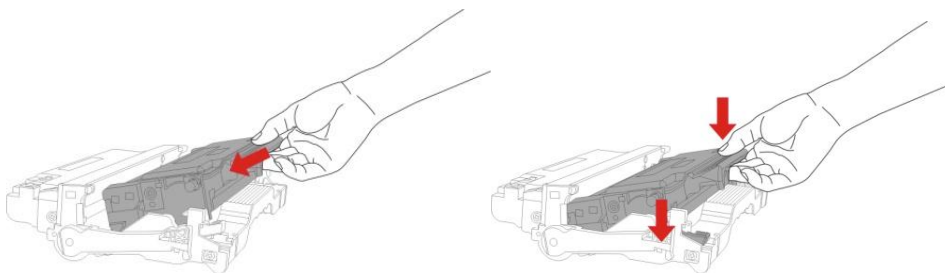

7. Take the drum component with toner cartridge installed and install it inside the printer along the inner track of printer to finish installing.

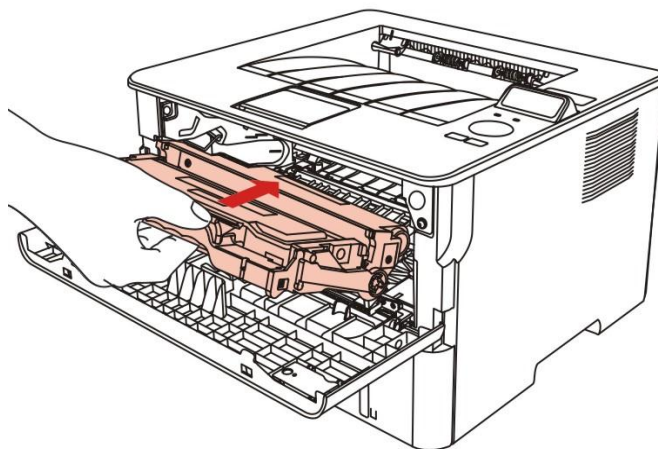

8. Close the front cover.

Drum component replacement steps:

1. Power off the printer.

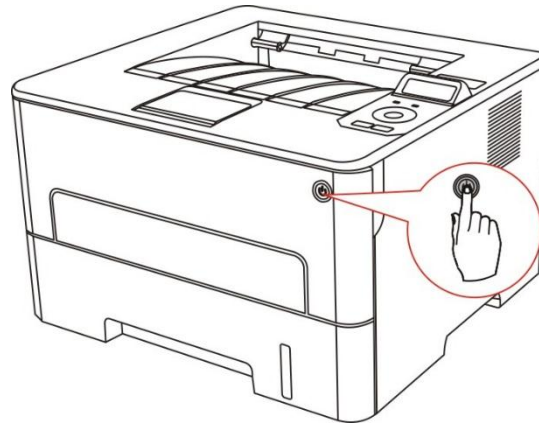

2. Open the front cover and take the laser toner cartridge out along the track.

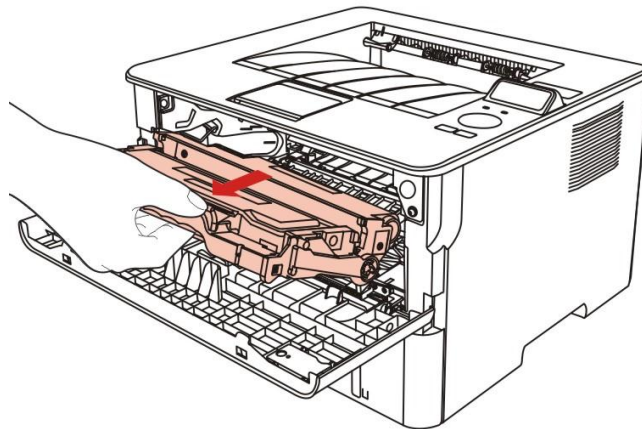

3. Press the blue button on the left side of drum component with left hand and lift the toner cartridge handle with right hand at the same time to take the toner cartridge out.

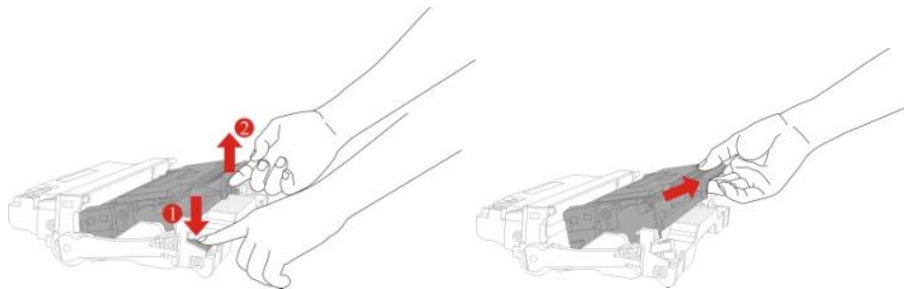

4. Open the package of new drum component, take the protection device of drum component, and put the drum component on a horizontal table.

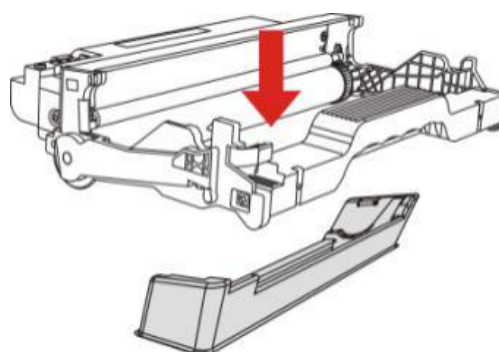

5. Install the drum component along the inner track to finish installing toner cartridge.

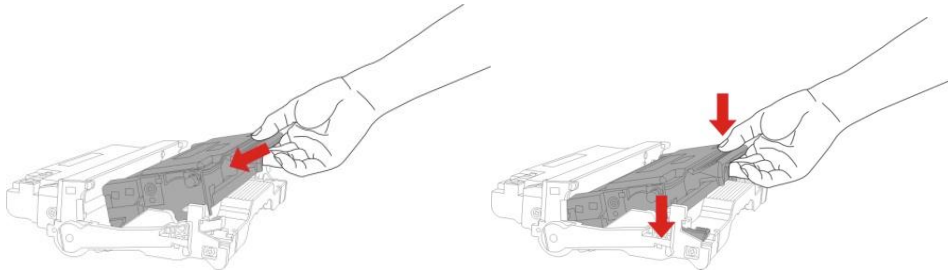

6. Take the drum component with toner cartridge installed and install it inside the printer along the inner track of printer to finish installing.

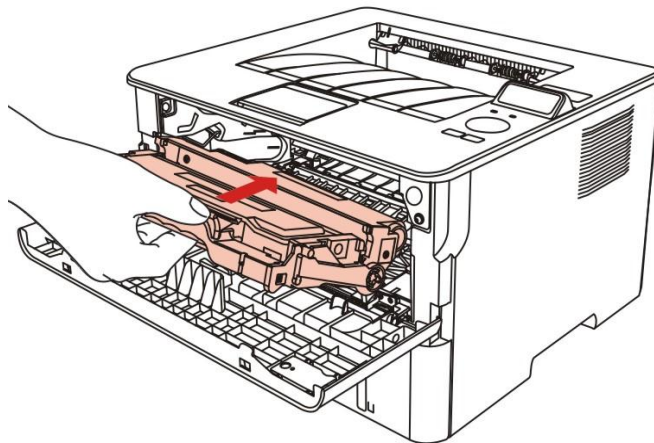

7. Close the front cover.

11. Troubleshooting

Please read this section carefully. It may help you to solve common problems encountered during the printing process. If the problems persist, please contact Aftersales Service Centre.

Prior to handling common problems, first check that:

- The power cord is connected correctly and the printer is powered on.
- All of the protective parts are removed.
- The toner cartridge is installed correctly.
- The paper is correctly loaded into the tray.
- The interface cable between the printer and the computer is connected correctly.
- The correct printer driver has been selected and installed properly.
- The computer port is properly configured and is connected to the correct printer port.

11.1. Cleaning Jammed Paper

11.1.1. Paper jam of auto feed tray

1. Open the tray.

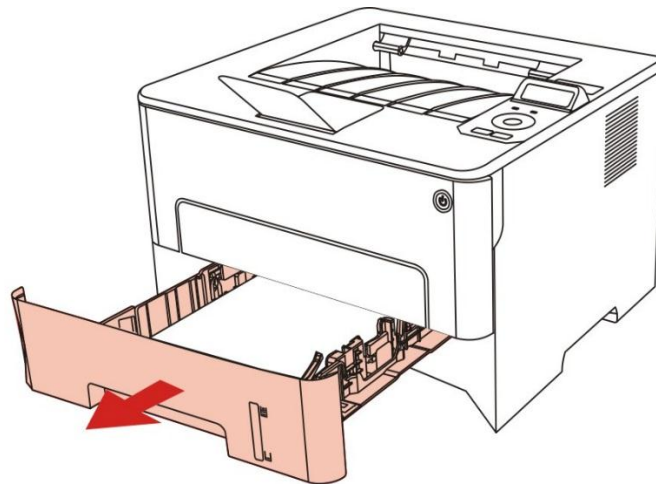

2. Gently pull the jammed paper out.

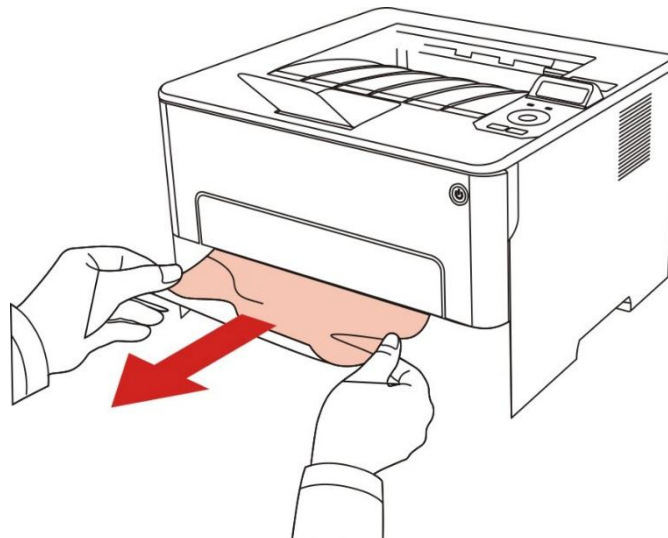

3. After taking papers jammed out, please reinstall the paper tray inside the printer and close the front cover, then the printer will recover printing automatically.

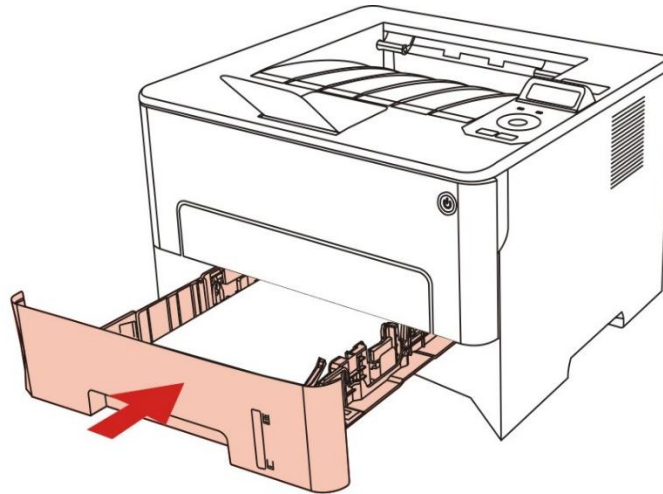

11.1.2. Paper jam of manual feed tray

1. Gently pull the jammed paper out.

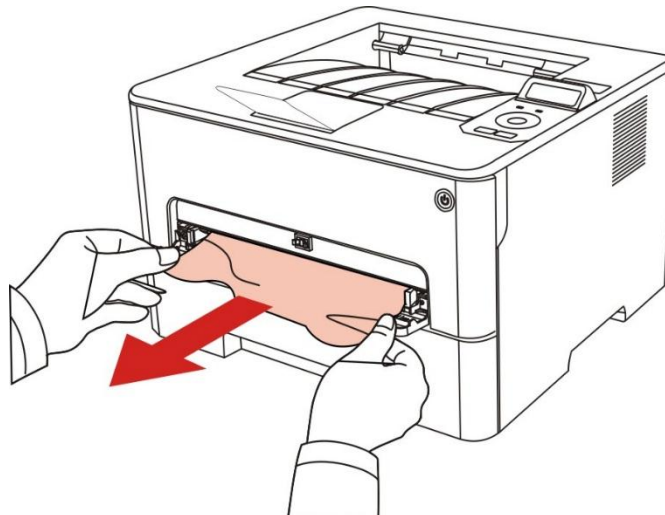

2. After taking papers jammed out, open and close the front cover and the printer will recover printing.

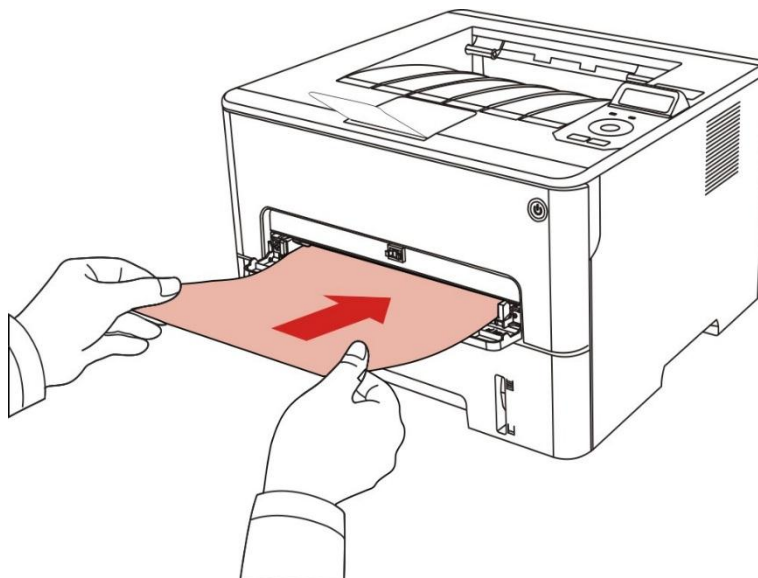

11.1.3. Middle jam

 **Note:** • When papers jammed in the middle are taken out, please pay attention and do not touch the shaded area shown below, in order to avoid burn.

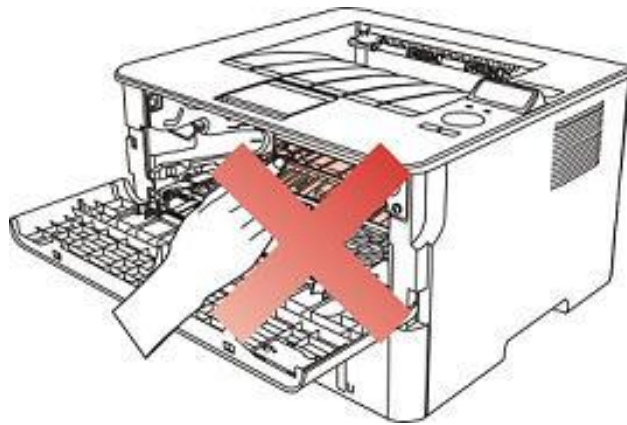

1. Pull paper tray out.

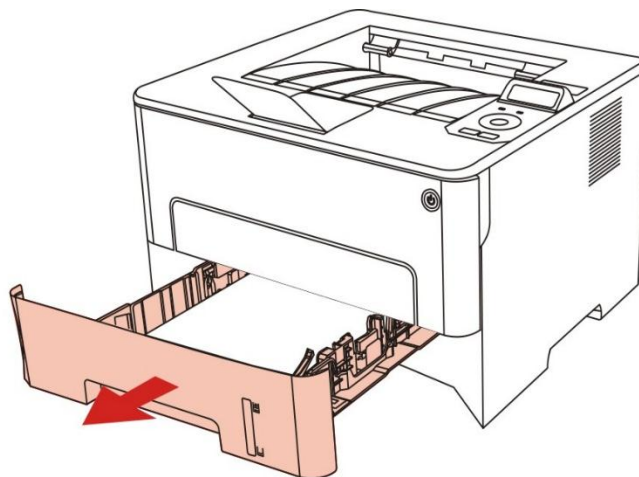

2. Gently pull the jammed paper out.

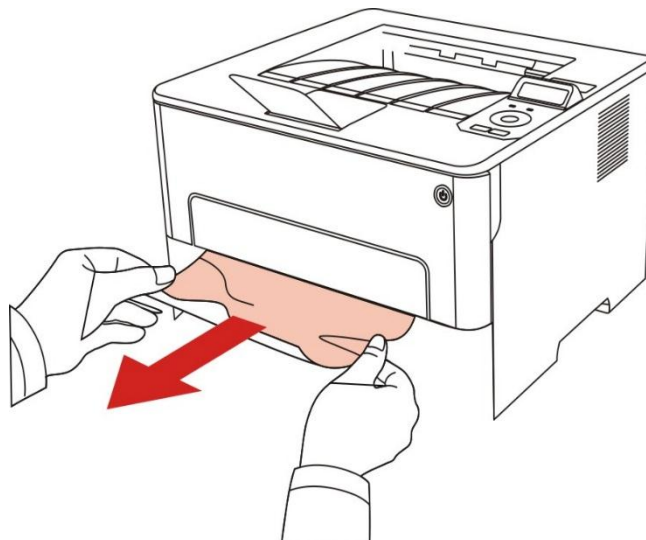

3. Install paper tray.

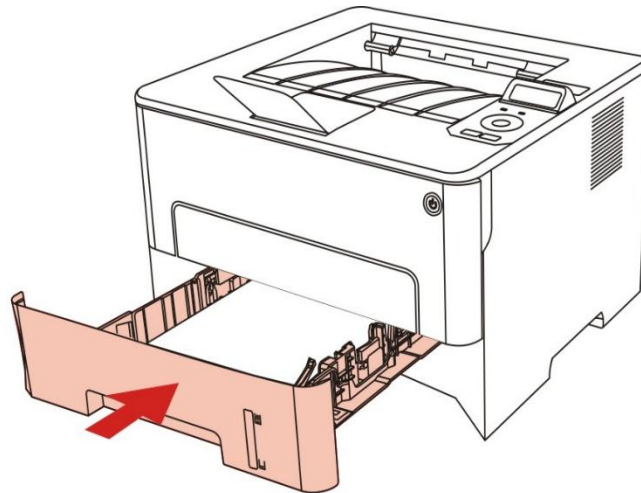

4. Open the front cover.

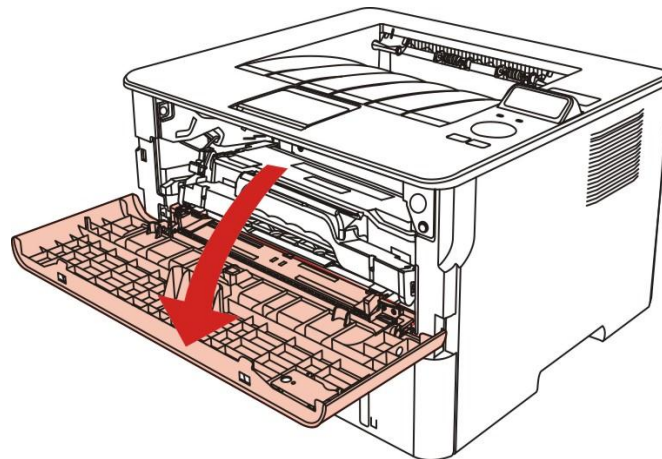

5. Take the laser toner cartridge out along the track. (For the purpose of preventing printing quality from affecting by the exposure of photosensitive drum, please put the laser toner cartridge inside the protection bag or wrap it with thick paper).

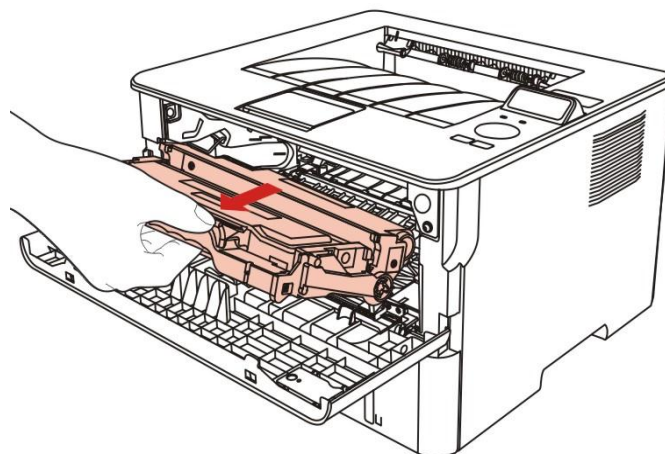

6. Gently pull the jammed paper out.

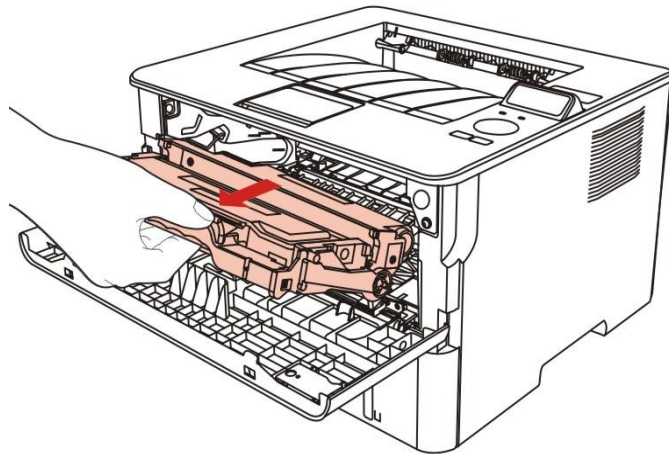

7. After taking out papers jammed, install the laser toner cartridge again and close the front cover, then the printer will recover printing.

11.1.4. Paper Jam in the Fuser Unit

 **Note:** • When papers jammed in fuser unit are taken out, please pay attention and do not touch the shaded area shown below in order to avoid burns.

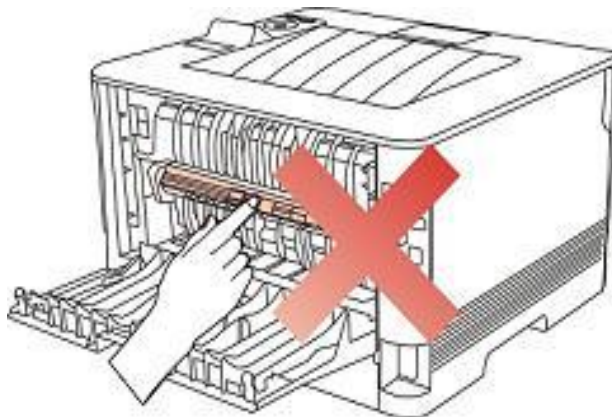

1. Open the rear cover.

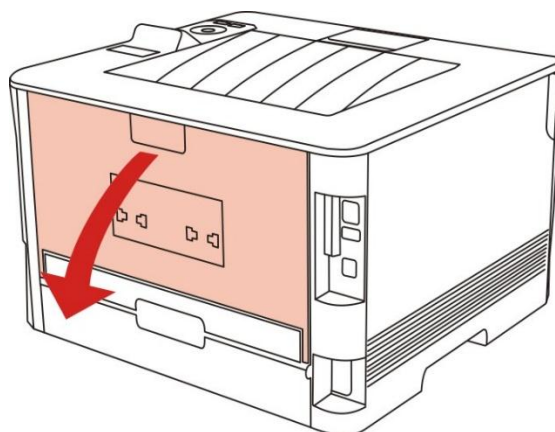

2. Open the fuser door using the handles on both sides.

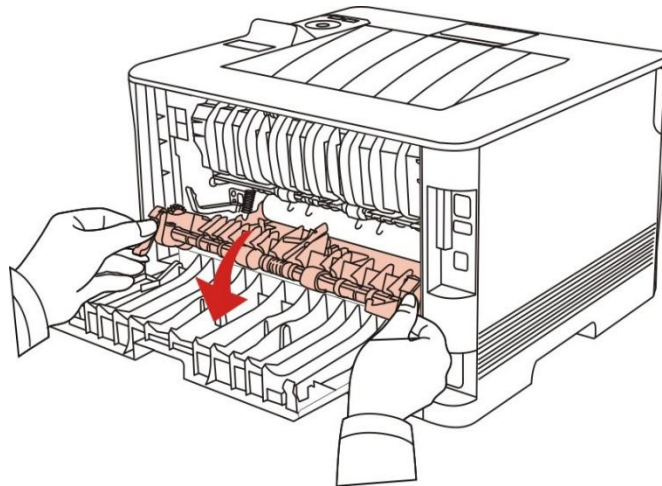

3. Gently pull the jammed paper out.

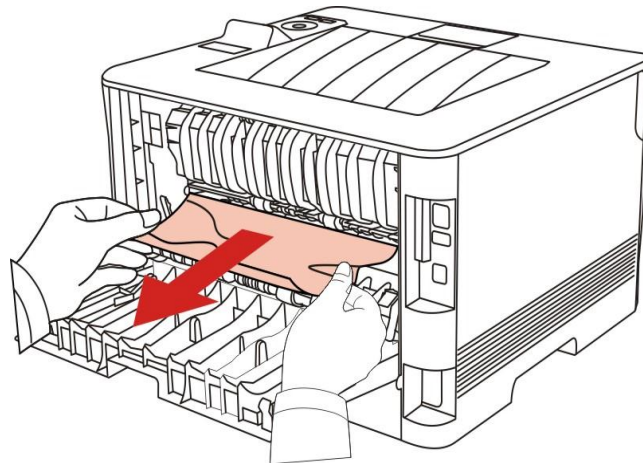

4. After taking papers jammed out, close the back cover and open the front cover and then the printer will recover printing.

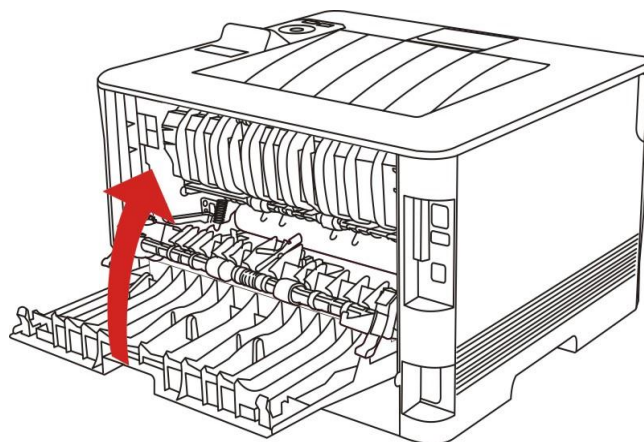

11.1.5. Duplex Unit Jam

1. Remove the duplex printing unit from the back of the printer.

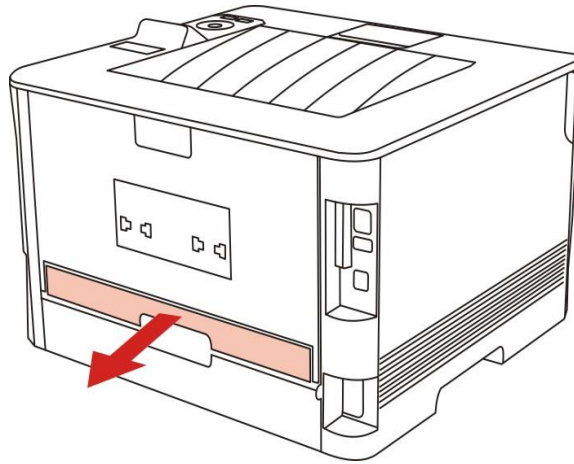

2. Remove the jammed paper from the duplex unit.

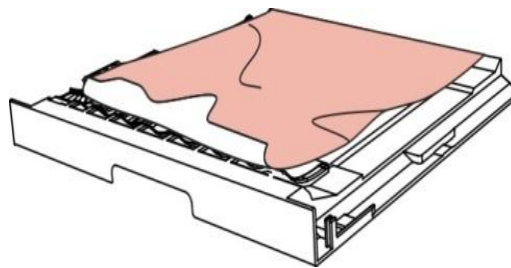

3. If the paper does not come out along with the duplex unit, open the tray and remove the jammed paper directly from the bottom.

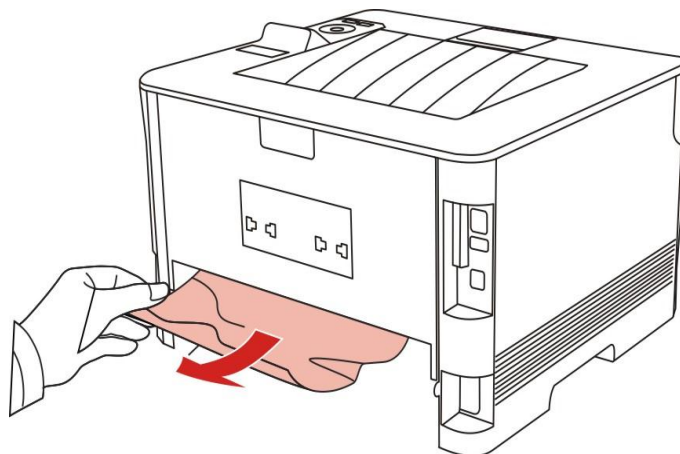

4. After taking papers jammed out, install the duplex unit back and inspect other parts to the product. If it can be ensured that there are no jammed papers, open and close the front cover and then the printer will recover printing automatically.

-
-  **Note:** • After all papers jammed are taken out according to the above steps, close the front cover and tidy the papers in paper tray, then the printer will recover to print automatically.
- If the printer still does not start printing, please check that all the jammed paper inside the printer has been cleared.
 - If you cannot remove the jammed paper yourself, please contact your local authorized repair center or send the printer to the nearest authorized service center for repair.
 - Printer appearance may differ because of various models and functions, so the schematic diagram is only for your reference.
-

11.2. Software Failure

Problem	Solution
The printer icon will not be displayed in the “Printers and Faxes” folder.	Reinstall the printer driver. Ensure that the USB interface cable and the power cord are properly connected.
The printer is in Ready mode but it will not perform any print job.	If the failure still exists after restarting the printer, please reinstall the printer driver. Make sure the network cable of USB cable is connected correctly.
Failed to install the driver	Check whether the print spooler service is enabled. Check the power supply and the connection of the printer.
The driver cannot be used if the IP address of the printer has been changed	Modify the port IP address of the printer driver. If the above method does not work, please reinstall the printer driver. It is recommended that a fixed IP address should be set to the network printer. In the DHCP network, it is recommended to bind the IP address with the Mac address of the printer.

11.3. Common Troubleshooting





11.3.1. Common Problems

Problem	Cause	Solution
Problems with the Printer		
The printer does not work	<p>The cable between the computer and the printer is not connected properly.</p> <p>Error in specifying the print port.</p> <p>The printer is offline and User Guide of Printer is checked.</p> <p>The printer has not recovered from an internal error, such as a paper jam, paper empty, etc.</p> <p>Driver program of printer is not installed correctly.</p>	<p>Disconnect and then reconnect the printer cable.</p> <p>Check the Windows printer settings to ensure that the print job has been sent to the correct port. If the computer has more than one port, make sure that the printer is connected to the correct port.</p> <p>Make sure that the printer is in the normal online status.</p> <p>Please eliminate errors so that the printer can recover to its normal state.</p> <p>Unload and reinstall the driver program of printer.</p>
Problems with Paper Handling		
Paper feed failure	<p>The print media has been loaded incorrectly.</p> <p>The print media is out of the supported media range.</p> <p>The feed roller is dirty.</p> <p>Too many papers in paper tray.</p>	<p>Please install printing medium correctly; please print with manual feed tray if special printing medium is used to print.</p> <p>Please use the print media within the specification range.</p> <p>Clean the feed roller.</p> <p>Take the excessive papers out from paper tray; please print with manual feed tray if special printing medium is used to print.</p>
Paper Jam	<p>Too many papers in paper tray.</p> <p>The print media is out of the supported media range.</p> <p>There is foreign matter in the paper path.</p> <p>The feed roller is dirty.</p> <p>Internal parts failure.</p>	<p>Take the excessive papers out from paper tray; please print with manual feed tray if special printing medium is used to print.</p> <p>Make sure to use the paper that meets specifications. please print with manual feed tray if special printing medium is used to print.</p> <p>Clean the paper path.</p> <p>Clean the feed roller.</p>
Print multipage feed	<p>Excessive static electricity on the print media.</p> <p>The print media is damp and is sticking together.</p> <p>Internal parts failure.</p>	<p>Separate the print media to eliminate some static electricity. It is suggested that you use the recommended print media.</p> <p>Separate the print media or use better quality and dry print media.</p>



Note: • If the problem still cannot be solved, please contact the customer services center.

11.3.2. Image Defects

Problem	Cause	Solution
 <p>The printout is whitish or light</p>	<ul style="list-style-type: none"> • The print media does not meet the usage specifications, for example the media is damp or too rough. • The resolution setting of printing program is too low and concentration setting is too low, or save toner mode is ticked. • Toner is low. • Toner cartridge is damaged. 	<ul style="list-style-type: none"> • Please use proper print media within the specification range. • Set the resolution and concentration setting of program, or cancel ticking the save toner mode. • It is suggested to replace the original toner cartridge.
 <p>Toner spots</p>	<ul style="list-style-type: none"> • Dirty toner cartridge or toner leakage. • Toner cartridge is damaged. • The print media does not meet the usage specifications, for example the media is damp or too rough, or has been used previously. • The paper path is dirty. 	<ul style="list-style-type: none"> • It is suggested to replace the original toner cartridge. • Please use the print media within the specification range. • Clean the paper path.
 <p>White spots</p>	<ul style="list-style-type: none"> • The print media does not meet the usage specifications, for example the media is damp or too rough, or has been used previously. • The paper path is dirty. • The drum inside toner cartridge is damaged. 	<ul style="list-style-type: none"> • Please use the print media within the specification range. • Clean the paper path. • It is suggested to replace the original toner cartridge.
 <p>Toner comes off</p>	<ul style="list-style-type: none"> • The print media does not meet the usage specifications, for example the media is damp or too rough, or has been used previously. • The printing paper medium set and paper medium placed are not consistent. • The inside of the printer is dirty. • Toner cartridge is damaged. • The parts inside the printer are damaged. 	<ul style="list-style-type: none"> • Please use printing medium within the specification scope, and use manual feed tray for printing in case of special medium. • Please print with corresponding paper medium. • Clean the inside of the printer. • It is suggested to replace the original toner cartridge.
 <p>Black vertical stripes</p>	<ul style="list-style-type: none"> • Dirty toner cartridge • Damaged inner parts of toner cartridge. • Dirty combining glass of inner laser of the machine. • The paper path is dirty. 	<ul style="list-style-type: none"> • Clean or replace toner cartridge • Clean the mirror of the laser at the back of the printer. • Clean the feed path of printer.



Black background(gray background)

- The print media does not meet the usage specifications, for example the media is damp or too rough, or has been used previously.
- Dirty toner cartridge
- Damaged inner parts of toner cartridge.
- The paper path is dirty.
- Abnormal internal transfer voltage of printer.

- Please use the print media within the specification range.
- Clean or replace toner cartridge
- Clean the paper path inside the printer.

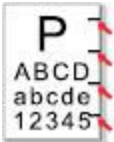

Cyclical traces appear

- Dirty toner cartridge
- Damaged inner parts of toner cartridge.
- The fuser component is damaged.

- Clean or replace toner cartridge
- Please contact customer services center to replace to a new fuser assembly.



Skewed pages

- The print media has been loaded incorrectly.
- The paper path of the printer is dirty.

- Ensure the correct loading of the print media.
- Clean the paper path inside the printer.



Wrinkled paper

- The print media has been loaded incorrectly.
- The print media does not meet the usage specifications.
- The paper path of the printer is dirty.
- The fuser component is damaged.

- Ensure the correct loading of the print media.
- Please use print media within the specification range.
- Clean the paper path inside the printer.
- Please contact customer services center to replace to a new fuser assembly.



The back of the printout is dirty

- Dirty toner cartridge
- The transfer roller inside the printer is dirty.
- The transfer voltage inside the printer is abnormal.

- Clean or replace toner cartridge
- Clean the internal transfer part of the printer.



Whole page dark

- Toner cartridge is improperly installed.
- Inner damage of toner cartridge.
- Abnormal internal charging of machine or the toner cartridge is not charged.

- Install ink cartridge correctly.
- It is suggested to replace the original toner cartridge.



The toner does not adhere to the paper

- The print media does not meet the usage specifications, for example the media is damp or too rough, or has been used previously.
- The inside of the printer is dirty.
- Toner cartridge is damaged.
- The parts inside the printer are damaged.

Please use printing medium within the specification scope, and use manual feed tray for printing in case of special medium.

- Clean the inside of the printer.
- It is suggested to replace the original toner cartridge.

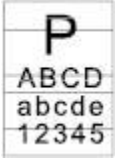

Horizontal stripes

- The toner cartridge is not installed correctly.
- The toner cartridge may be damaged.
- The parts inside the printer are damaged.

- Install ink cartridge correctly.
- It is suggested to replace the original toner cartridge.

 **Note:** • Failures above can be improved by cleaning or replacing toner cartridge. Please contact customer services center if the problem can still not be solved.

12. Menu Structure

With the help of menu structure of this printer on the panel menu, you may know and set various functions. The steps of printing are as follows:

1. Press "Menu" to enter the menu setting interface.
2. Press "▲" or "▼" to select "Prt Info Rept".
3. Press "OK" and then "▲" or "▼" to select "Menu Struc Pg".
4. Press "OK" to print.

13. Product Specifications



- Note:**
- Specification values vary slightly from printers with different models with different functions, and product specifications vary from different countries and regions.
 - Some functions are not available depending on different printer models. If you have any questions, please contact the Customer Service.

13.1. Overview of the Specifications

Product Size(W*D*H)	333mm*355mm*215mm
Product Weight	6.8kg
Print Environment	Print temperature range:10~32°C
	Print humidity range:20%RH~80%RH
Power Voltage	110V Model: AC100-127V, 50Hz/60Hz, 9A
	220V Model: AC220-240V, 50Hz/60Hz, 4.5A
Noise (acoustic pressure level)	Printing: ≤52dB(A)
	Standby:≤30dB(A)
	Mute mode: ≤46 dB (A)
Enter network standby time	1 minute
Power Consumption	Network standby: 1.72W
	Standby: ≤50W
	Shutdown: ≤0.5W
Operating system	Microsoft Windows XP/ Windows Vista/ Windows 7/ Windows 8/ Windows 8.1/ Windows 10/ Windows Server 2003/ Windows Server 2008/ Windows Server 2012 (32/64 Bit)
	macOS 10.7/10.8/10.9/10.10/10.11/10.12/10.13/10.14
	Ubuntu 14.04/ Ubuntu 16.04/ Ubuntu 18.04 (32/64 Bit)

Communication interface	USB 2.0 (High Speed)
	IEEE802.3 10Base-T/100Base-Tx
	IEEE802.11b/g/n (support WPS)
Print Time of First Page	≤8.5 sec
Maximum printable size	216mm*356mm

