



Document Solutions

> PRINT > COPY > SCAN

ECOSYS M6026cidn
ECOSYS M6026cidn Type B

> PRINT > COPY > SCAN > FAX

ECOSYS M6526cidn
ECOSYS M6526cidn Type B

OPERATION GUIDE



Introduction

Thank you for your purchase of ECOSYS M6026cidn/ECOSYS M6526cidn.

This Operation Guide is intended to help you operate the machine correctly, perform routine maintenance, and take simple troubleshooting measures as needed so that the machine can always be used in the optimum condition.

Please read this Operation Guide before using the machine.

We recommend the use of our own brand supplies.

Please use our genuine toner containers, which have passed rigorous quality control testing.

The use of non-genuine toner containers may cause failure.

We will not be liable for any damages caused by the use of third party supplies in this machine.

A label is affixed to our genuine supplies as shown below.

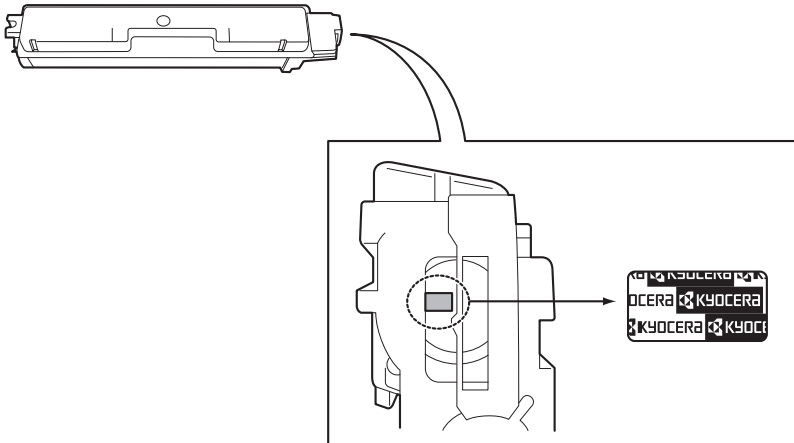

This Operation Guide also includes instructions on ECOSYS M6026cidn Type B and ECOSYS M6526cidn Type B.

Included Guides

The following guides are supplied with the machine. Refer to them as necessary.

Quick Installation Guide	Describes the procedures for installation of the machine, frequently-used operations, routine maintenance, and troubleshooting action.
Safety Guide	Provides safety and cautionary information for the installation and use of the machine. Be sure to read this guide before using the machine.
Safety Guide (ECOSYS M6026cidn/ ECOSYS M6526cidn)	Describes the machine installation space, cautionary space, and other information. Be sure to read this guide before using the machine.

DVD (Product Library)

Operation Guide (This Guide)	Describes how to load paper, basic copy, print and scan operations, and troubleshooting.
FAX Operation Guide	Describes fax functionality.
Card Authentication Kit (B) Operation Guide	Describes how to authenticate to the machine using the ID card.
Command Center RX User Guide	Describes how to access the machine from a computer via a Web browser to check and change settings.
Printer Driver Operation Guide	Describes how to install the printer driver and use printer functionality.
Network FAX Driver Operation Guide	Describes how to install and use the network fax driver in order to use network fax functionality.
KYOCERA Net Direct Print Operation Guide	Describes how to use functionality for printing PDF files without launching Adobe Acrobat or Reader.
KYOCERA Net Viewer User Guide	Describes how to monitor the network printing system with KYOCERA Net Viewer.
PRESCRIBE Commands Technical Reference	Describes the native printer language (PRESCRIBE commands).
PRESCRIBE Commands Command Reference	Describes PRESCRIBE command functionality and control for each type of emulation.

Contents

1	Preface	1-1
	Notice	1-2
	Safety Conventions in This Guide	1-2
	Environment	1-3
	Precautions for Use	1-3
	Laser Safety (Europe)	1-4
	SAFETY OF LASER BEAM (USA)	1-5
	Safety Instructions Regarding the Disconnection of Power	1-6
	WARNING	1-6
	Radio Tag Technology	1-6
	Other precautions (for users in California, the United States)	1-6
	Warranty (the United States)	1-7
	Legal Restriction on Copying/Scanning	1-8
	Legal and Safety Information	1-9
	Legal Information	1-9
	Energy Saving Control Function	1-12
	Automatic 2-Sided Copy Function	1-12
	Paper Recycling	1-12
	Energy Star (ENERGY STAR®) Program	1-12
	About this Operation Guide	1-13
	Conventions in This Guide	1-13
	Originals and Paper Sizes	1-15
2	Preparation before Use	2-1
	Part Names	2-2
	Machine	2-2
	Operation Panel	2-6
	Touch Panel	2-7
	Determining the Connection Method and Preparing Cables	2-8
	Connection Example	2-8
	Preparing Necessary Cables	2-9
	Connecting Cables	2-10
	Connecting LAN Cable	2-10
	Connecting USB Cable	2-11
	Connecting the Power Cable	2-11
	Power On/Off	2-13
	Power On	2-13
	Power Off	2-13
	Installing Software	2-15
	Software on DVD (Windows)	2-15
	Installing Printer Driver in Windows	2-16
	Uninstalling the Software	2-21
	Installing Printer Driver in Macintosh	2-21
	Setting TWAIN Driver	2-24
	Setting WIA Driver	2-26
	Energy Saver function	2-27
	Low Power Mode	2-27
	Sleep and Auto Sleep	2-28
	Machine Setup Wizard	2-29
	Command Center RX	2-30
	Accessing Command Center RX	2-31
	Changing Security Settings	2-32
	Changing Device Information	2-33
	E-mail settings	2-34
	Registering Destinations	2-37
	Registering a Custom Box	2-38

3 Common Operations 3-1

- Loading Paper 3-2
 - Before Loading Paper 3-2
 - Loading Paper in the Cassettes 3-3
 - Loading Paper in the Multi Purpose Tray 3-6
- Loading Originals 3-10
 - Placing Originals on the Platen 3-10
 - Loading Originals in the Document Processor 3-11
- Checking the Equipment's Serial Number 3-13
- Checking the Counter 3-14
- Login/Logout 3-15
 - Login 3-15
 - Logout 3-16
- Favorites 3-17
 - Registering Favorites 3-17
 - Editing and Deleting Favorites 3-21
 - Using Favorites 3-23
- Shortcuts 3-25
 - Registering Shortcuts 3-25
 - Editing and Deleting Shortcuts 3-27
 - Using Shortcuts 3-28
- Quick Setup Wizard 3-29
- Help Screen 3-31
- Canceling Jobs 3-32
- Using Various Functions 3-33
 - Common Functionality 3-34
 - Original Size 3-35
 - Original Orientation 3-36
 - Duplex 3-37
 - Continuous Scan 3-39
 - Paper Selection 3-41
 - Collate 3-42
 - Density 3-43
 - Scan Resolution 3-44
 - Original Image 3-45
 - EcoPrint 3-46
 - Sharpness 3-47
 - Background Density Adjust 3-48
 - Zoom 3-49
 - File Format 3-50
 - Color Selection 3-53
 - Job Finish Notice 3-54
 - File Name Entry 3-56
 - Priority Override 3-57

4 Copying 4-1

- Basic Operation 4-2
- Copying Functions 4-4
 - Zoom 4-5
 - Duplex 4-7
 - Combine 4-10
 - Hue Adjustment 4-13
 - Color Balance 4-14
 - Saturation 4-15

5	Printing	5-1
	Printing from Applications	5-2
	Printing Data Saved on the Printer	5-6
	Private Print/Stored Job	5-6
	Quick Copy/Proof and Hold	5-8
	Automatic Delete Setting for Temporary Documents	5-11
6	Sending	6-1
	Basic Operation	6-2
	Preparation for Sending a Document to a PC	6-5
	Checking What to Enter for [Host Name]	6-5
	Checking What to Enter for [Login User Name]	6-6
	Creating a Shared Folder	6-7
	Configuring Windows Firewall (for Windows 7)	6-10
	Specifying Destination	6-14
	Choosing from the Address Book	6-14
	Choosing by One Touch Key	6-16
	Entering a New E-mail Address	6-17
	Specifying a New PC Folder	6-18
	Checking and Editing Destinations	6-22
	Sending to Different Types of Destinations (Multi Sending)	6-23
	Registering Destinations in the Address Book	6-24
	Adding a Contact	6-24
	Adding a Group	6-28
	Editing and Deleting Address Book Entries	6-31
	Adding a Destination on One Touch Key	6-33
	Adding a Destination	6-33
	Editing and Deleting One Touch Key	6-35
	Sending Functions	6-36
	Sending Size	6-37
	File Separation	6-39
	E-mail Subject/Body	6-40
	FTP Encrypted TX	6-41
	WSD Scan	6-42
	Scanning using TWAIN	6-45
7	Document Box	7-1
	What is Document Box?	7-2
	Using a Custom Box	7-3
	Creating a New Custom Box (Add/Edit Box)	7-3
	Editing Custom Box	7-8
	Storing Documents (Store File)	7-12
	Printing Documents (Print)	7-13
	Moving a Document	7-15
	Auto File Deletion Time	7-16
	Printing Documents Stored in Removable USB Memory	7-17
	Saving Documents to USB Memory (Scan to USB)	7-20
	Removing USB Memory	7-22
	Functions for Document Box	7-23
	Delete after Printed	7-25
	Duplex	7-26
	Encrypted PDF Password	7-27
	JPEG/TIFF Print	7-28
	XPS Fit to Page	7-29
	Storing Size	7-30

8	Status / Job Cancel	8-1
	Checking Job Status	8-2
	Details of the Status Screens	8-3
	Checking Job History	8-7
	Sending the Log History	8-8
	Setting the Destination	8-9
	Automatic Log History Transmission	8-10
	Manual Log History Transmission	8-10
	Setting E-mail Subject	8-11
	Personal information in the job log	8-12
	Check of Device Status	8-13
	Checking the Remaining Amount of Toner and Paper	8-16
9	Setup, Registration, and User Management	9-1
	System Menu	9-2
	Operation Method	9-2
	System Menu Settings	9-3
	Language	9-5
	Report	9-5
	User Property	9-7
	Cassette/MP Tray Settings	9-7
	Common Settings	9-9
	Copy	9-14
	Send	9-15
	Favorites/Application	9-16
	Internet	9-16
	Printer	9-17
	System/Network	9-19
	Date/Timer/Energy Saver	9-27
	Adjustment/Maintenance	9-28
	Color Registration Procedure	9-30
	User Login Administration	9-36
	First User Login Administration	9-36
	User Login Settings	9-37
	Enabling/Disabling User Login Administration	9-38
	Adding a User	9-40
	Local User Authorization	9-45
	My Panel	9-46
	Editing and Deleting Users	9-47
	ID Card Settings	9-50
	Simple Login	9-51
	Group Authorization	9-57
	Obtain Network User Property	9-61
	Job Accounting	9-63
	First Job Accounting Setup	9-63
	Job Accounting Settings	9-65
	Enabling/Disabling Job Accounting	9-66
	Login/Logout	9-67
	Job Accounting Access	9-68
	Adding an Account	9-69
	Editing and Deleting Accounts	9-71
	Restricting the Use of the Machine	9-73
	Counting the Number of Pages Printed	9-75
	Printing an Accounting Report	9-77
	Job Accounting Default Setting	9-78
	Unknown Login User Name Job	9-79

10	Troubleshooting	10-1
	Toner Container Replacement	10-2
	Waste Toner Box Replacement	10-4
	Cleaning	10-6
	Glass Platen	10-6
	Document Processor	10-6
	Paper Transfer Unit	10-7
	Solving Malfunctions	10-8
	Responding to Error Messages	10-13
	Clearing Paper Jams	10-22
	Paper Jam Location	10-22
	Multi Purpose Tray	10-23
	Cassette	10-23
	Paper Feeder	10-24
	Inside the Machine	10-24
	Document Processor	10-26
11	Appendix	11-1
	Optional Equipment	11-2
	Overview of Optional Equipment	11-2
	Paper Feeder	11-2
	Expansion Memory	11-3
	Card Authentication Kit	11-4
	SSD	11-4
	Network Interface Kit	11-5
	Wireless Network Interface Kit	11-5
	USB Keyboard	11-5
	ThinPrint Option	11-5
	Optional Function	11-6
	Character Entry Method	11-8
	Entry Screens	11-8
	Entering Characters	11-10
	Paper	11-11
	Basic Paper Specifications	11-12
	Choosing the Appropriate Paper	11-12
	Special Paper	11-15
	Specifications	11-19
	Common Functions	11-19
	Copy Functions	11-20
	Printer Functions	11-21
	Scanner	11-21
	Document Processor	11-22
	Environmental Specifications	11-22
	Glossary	11-23
	Index	Index-1



Quick Guide

Be sure to read *Precautions for Use* before using this machine.



To make copies

Simply press the **Start** key to make copies. You can also fine-tune the copy settings by changing the paper size, adjusting the density, etc.



To print

You can print via a network or print a PDF file directly from USB memory.

Administrator tasks

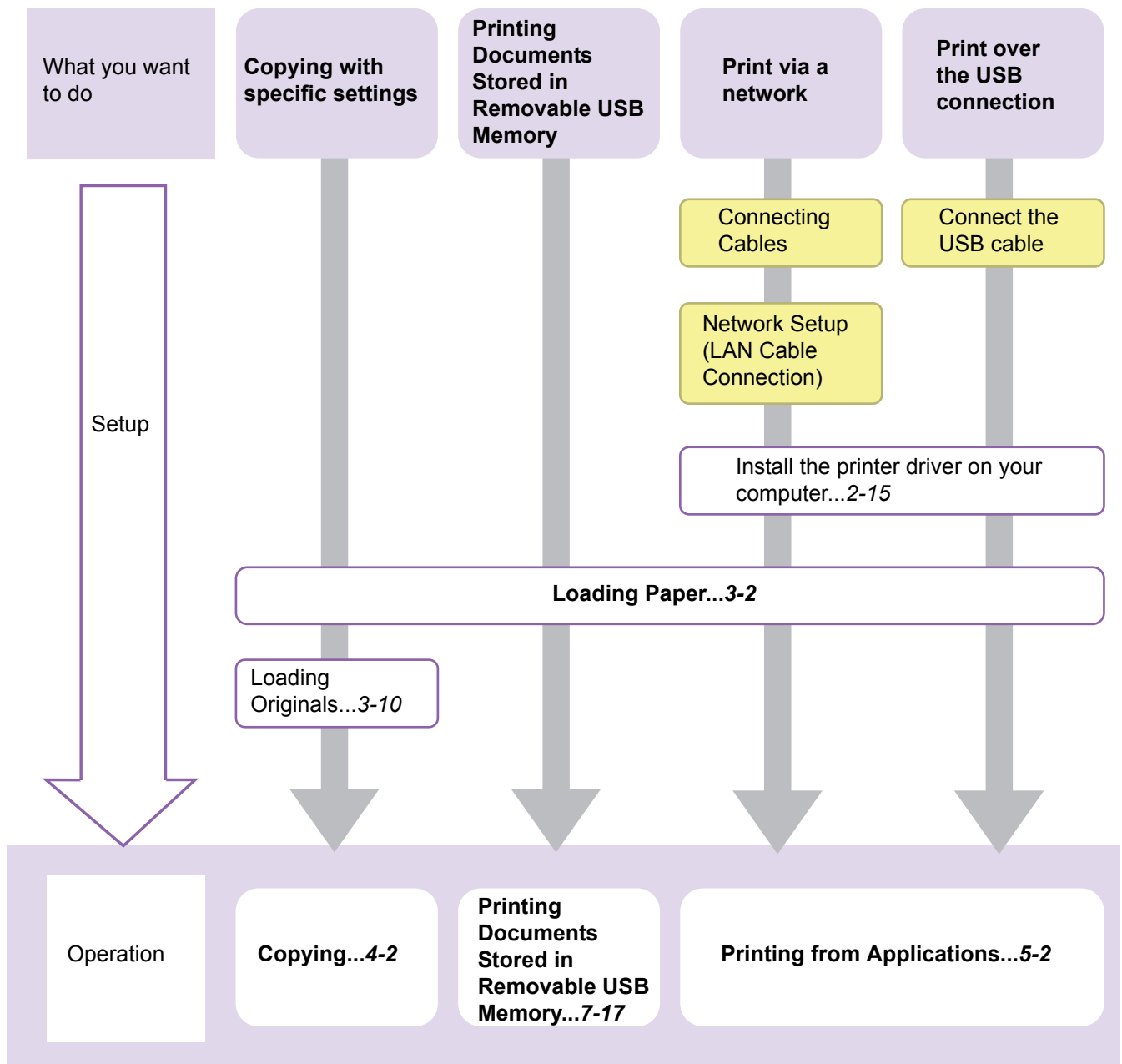



To send documents

You can send scanned images via a network. Or, you can also store scanned images in USB memory.

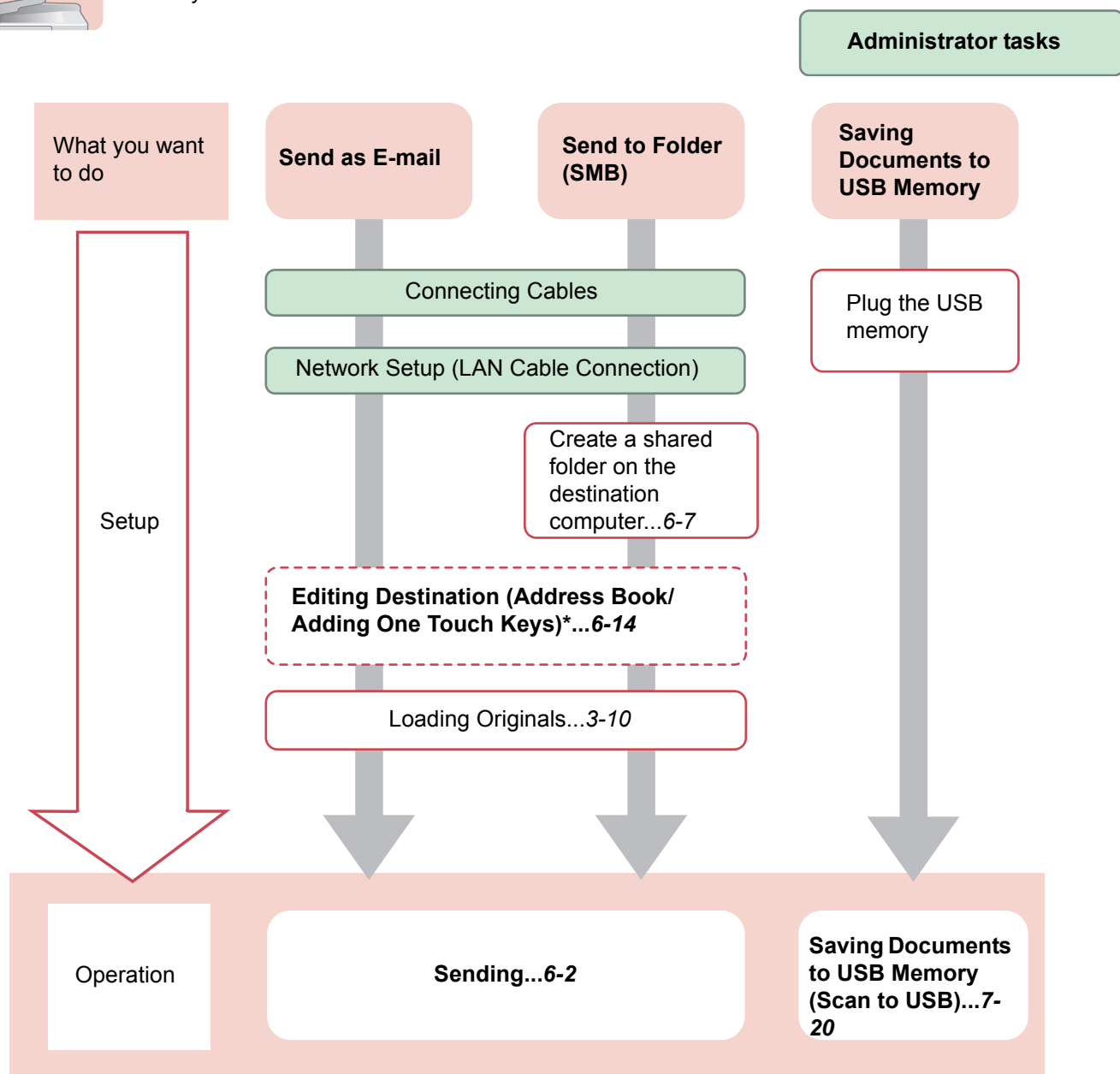

* If the destination is not stored in the address book, you can send by entering the address directly.



To send a FAX (Only on products with the fax function installed)

As well as sending a FAX via the telephone lines, you can also send a FAX via a network.



NOTE

For more information on setting up and sending a FAX, refer to the *FAX Operation Guide*.

Administrator tasks

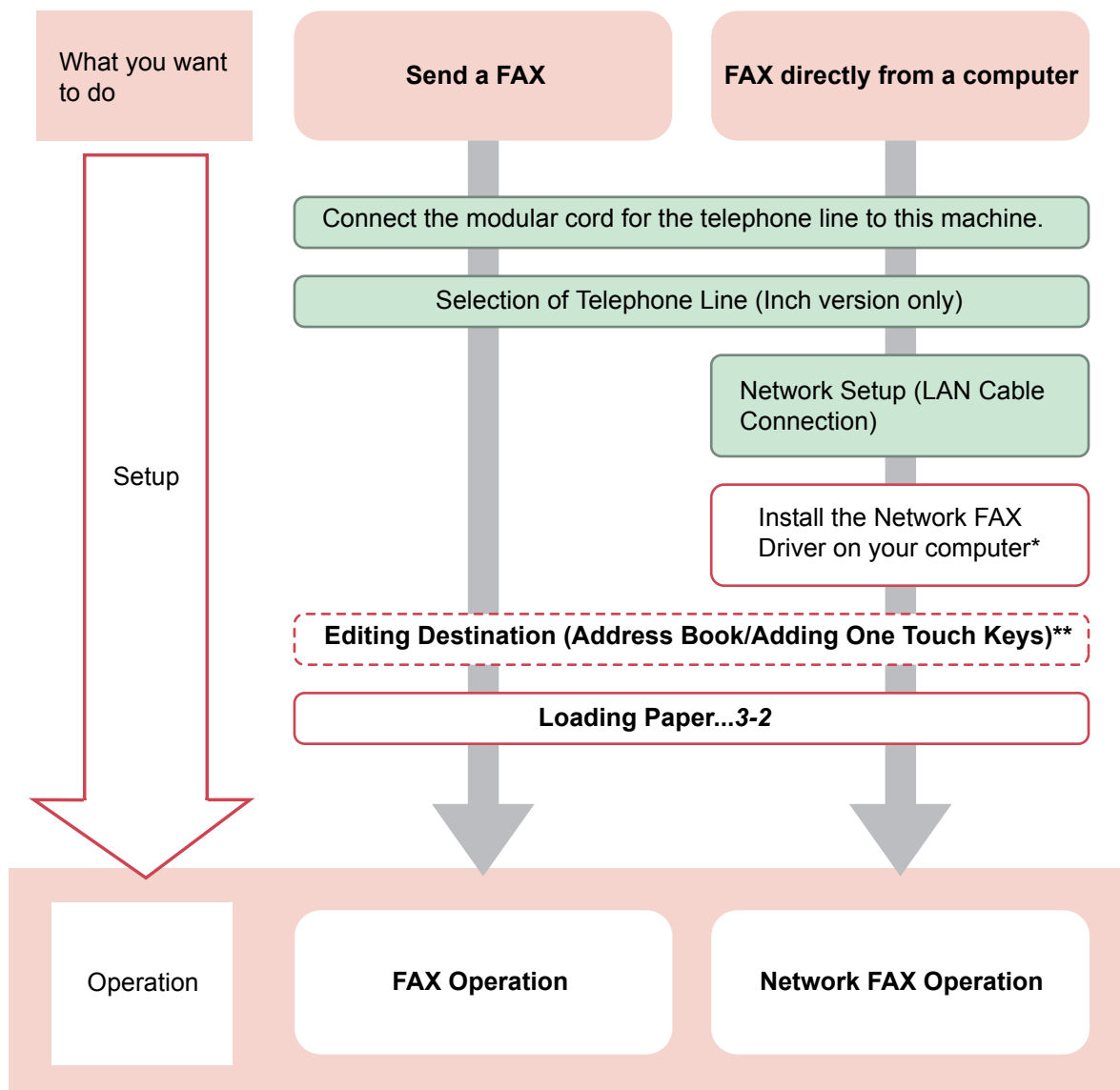

* For more information, refer to the *Network FAX Driver Operation Guide*.

** If the destination is not stored in the address book, you can send the FAX by entering the address directly.

Menu Map

Copy



Copies (page 4-3)	
Paper Selection (page 3-41)	
Zoom (page 4-5)	
Density (page 3-43)	
Duplex (page 4-7)	
Combine (page 4-10)	
Collate (page 3-42)	
Functions	Original Size (page 3-35)
	Original Orientation (page 3-36)
	Color Selection (page 3-53)
	Original Image (page 3-45)
	EcoPrint (page 3-46)
	Hue Adjustment (page 4-13)
	Color Balance (page 4-14)
	Sharpness (page 3-47)
	Background Density Adj. (page 3-48)
	Saturation (page 4-15)
	Continuous Scan (page 3-39)
	Job Finish Notice (page 3-54)
	File Name Entry (page 3-56)
	Priority Override (page 3-57)
Add/Edit Shortcut (page 3-25)	

Send



One Touch Key (page 6-16)	
Address Book (page 6-14)	
Ext. Address Book (refer to <i>Command Center RX User Guide</i>)	
E-mail (page 6-17)	
Folder (page 6-18)	
FAX (refer to <i>Fax Operation Guide</i>)	
WSD Scan (page 6-42)	
Functions	File Format (page 3-50)
	Original Size (page 3-35)
	Original Orientation (page 3-36)
	Duplex (page 3-37)
	Sending Size (page 6-37)
	File Separation (page 6-39)
	Scan Resolution (page 3-44)
	Density (page 3-43)
	Color Selection (page 3-53)
	Original Image (page 3-45)
	Sharpness (page 3-47)
	Background Density Adj. (page 3-48)
	FAX TX Resolution (refer to <i>Fax Operation Guide</i>)
	Zoom (page 3-49)
	Continuous Scan (page 3-39)
	File Name Entry (page 3-56)
	E-mail Subject/Body (page 6-40)
	Job Finish Notice (page 3-54)
	FTP Encrypted TX (page 6-41)
	FAX Delayed Transmission (refer to <i>Fax Operation Guide</i>)
FAX Direct Transmission (refer to <i>Fax Operation Guide</i>)	
FAX Polling RX (refer to <i>Fax Operation Guide</i>)	
FAX TX Report (refer to <i>Fax Operation Guide</i>)	
Add/Edit Shortcut (page 3-25)	

Document
Box



Custom Box	Menu	Add (page 7-3)	
		Edit (page 7-8)	
		Delete (page 7-8)	
	Print	Copies (page 7-14)	
		Paper Selection (page 3-41)	
		Collate (page 3-42)	
		Duplex (page 7-26)	
		Delete after Print (page 7-25)	
		Functions	Priority Override (page 3-57)
	File Name Entry (page 3-56)		
Job Finish Notice (page 3-54)			
Add/Edit Shortcut (page 3-25)			
Job Box (page 5-6)			
Removable Memory	Menu	Store File	File Format (page 3-50)
			Duplex (page 3-37)
			Scan Resolution (page 3-44)
			Density (page 3-43)
			File Name Entry (page 3-56)
		Functions	Original Size (page 3-35)
			Original Orientation (page 3-36)
			Storing Size (page 7-30)
			Color Selection (page 3-53)
			Original Image (page 3-45)
			Sharpness (page 3-47)
			Background Density Adj. (page 3-48)
			Zoom (page 3-49)
			Continuous Scan (page 3-39)
Job Finish Notice (page 3-54)			
File Separation (page 6-39)			
Add/Edit Shortcut (page 3-25)			

	Print	Copies (page 7-18)	
		Paper Selection (page 3-41)	
		Collate (page 3-42)	
		Duplex (page 7-26)	
	Functions	Color Selection (page 3-53)	
		EcoPrint (page 3-46)	
		Job Finish Notice (page 3-54)	
		Priority Override (page 3-57)	
		Encrypted PDF Password (page 7-27)	
		JPEG/TIFF Print (page 7-28)	
XPS Fit to Page (page 7-29)			
Add/Edit Shortcut (page 3-25)			
Sub Address Box (refer to <i>Fax Operation Guide</i>)			
Polling Box (refer to <i>Fax Operation Guide</i>)			

Status/ Job Cancel



Print Job Status (page 8-3)
Send Job Status (page 8-4)
Store Job Status (page 8-5)
Scheduled Job (page 8-6)
Print Job Log (page 8-7)
Send Job Log (page 8-7)
Store Job Log (page 8-7)
FAX Job Log (page 8-7)
Scanner (page 8-13)
Printer (page 8-14)
FAX (page 8-14)
Toner Status (page 8-16)
Paper Status (page 8-16)
Removable Memory (page 8-14)
Connection Status (page 8-14)
SSD (page 8-15)

◆ System Menu / Counter



Quick Setup Wizard (page 3-29)	FAX Setup (page 3-29)	
	Paper Setup (page 3-29)	
	Energy Saver Setup (page 3-29)	
	Network Setup (page 3-29)	
Language (page 9-5)		
Report (page 9-5)	Report Print (page 9-5)	Status Page (page 9-5)
		Font List (page 9-5)
		Network Status (page 9-5)
		Service Status (page 9-6)
		Accounting Report (page 9-6)
		Sub Address Box List (refer to <i>Fax Operation Guide</i>)
		FAX List (Index) (refer to <i>Fax Operation Guide</i>)
		FAX List (No.) (refer to <i>Fax Operation Guide</i>)
		Outgoing FAX Report (refer to <i>Fax Operation Guide</i>)
		Incoming FAX Report (refer to <i>Fax Operation Guide</i>)
	Admin Report Settings (refer to <i>Fax Operation Guide</i>)	
	Result Report Setting (page 9-6)	Send Result Report (page 9-6)
		RX Result Report (refer to <i>Fax Operation Guide</i>)
		Job Finish Notice Setting (page 9-6)
	Sending Log History (page 8-8)	Send Log History (page 8-10)
		Auto Sending (page 8-10)
		Destination (page 8-9)
		Job Log Subject (page 8-11)
		Personal Information (page 8-11)
Counter	Printed Pages (page 3-14)	
	Scanned Pages (page 3-14)	

User Property (page 9-7)	User Name (page 9-7)		
	Login User Name (page 9-7)		
	Login Password (page 9-7)		
	Access Level (page 9-7)		
	Account Name (page 9-7)		
	E-mail Address (page 9-7)		
	ID Card Info. (page 9-7)		
	Simple Login (page 9-7)		
	My Panel (page 9-7)		
	Group Name (page 9-7)		
Group ID (page 9-7)			
Cassette/MP Tray Settings (page 9-7)	Cassette 1 (to 3) (page 9-7)	Paper Size (page 9-7)	
		Media Type (page 9-7)	
	Multi Purpose Tray (page 9-8)	Paper Size (page 9-8)	
		Media Type (page 9-8)	
Common Settings (page 9-9)	Default Screen (page 9-9)		
	Sound (page 9-9)	Buzzer (page 9-9)	Volume (page 9-9)
			Key Confirmation (page 9-9)
			Job Finish (page 9-9)
			Ready (page 9-9)
			Warning (page 9-9)
			Key Confirmation (USB Keyboard) (page 9-9)
		FAX Speaker Volume (refer to <i>Fax Operation Guide</i>)	
	FAX Monitor Volume (refer to <i>Fax Operation Guide</i>)		
	Original Settings (page 9-9)	Custom Original Size (page 9-9)	
		Default Original Size (page 9-9)	
	Paper Settings (page 9-10)	Custom Paper Size (page 9-10)	
		Media Type Settings (page 9-10)	
		Default Paper Source (page 9-10)	
		Paper Selection (page 9-10)	
Media for Auto (Color) (page 9-10)			
Media for Auto (B & W) (page 9-10)			
Special Paper Action (page 9-10)			

	Function Defaults (page 9-11)	File Format (page 9-11)
		Original Orientation (page 9-11)
		Collate (page 9-11)
		File Separation (page 9-11)
		Scan Resolution (page 9-11)
		Color Selection (Copy) (page 9-11)
		Color Select.(Send/Store) (page 9-12)
		Original Image (Copy) (page 9-12)
		Original Image (Send/Store) (page 9-12)
		Background Density Adj. (Copy) (page 9-12)
		Background Density Adj. (Send/Store) (page 9-12)
		EcoPrint (page 9-12)
		FAX TX Resolution (refer to <i>Fax Operation Guide</i>)
		Zoom (page 9-12)
		Continuous Scan (Except FAX) (page 9-12)
		Continuous Scan (FAX) (refer to <i>Fax Operation Guide</i>)
		File Name Entry (page 9-12)
		E-mail Subject/Body (page 9-12)
		FTP Encrypted TX (page 9-12)
		JPEG/TIFF Print (page 9-12)
	XPS Fit to Page (page 9-12)	
	Detail Settings (page 9-13)	Image Quality (page 9-13)
		PDF/A (page 9-13)
		High Comp. PDF (page 9-13)
	Preset Limit (page 9-13)	
	Error Handling (page 9-13)	Duplexing Error (page 9-13)
		Paper Mismatch Error (page 9-13)
	Measurement (page 9-13)	
	Low Toner Alert Level (page 9-13)	
Keyboard Layout (page 9-14)		
USB Keyboard Type (page 9-14)		
Format SSD (page 9-14)		
Display Status/Log (page 9-14)	Display Jobs Detail Status (page 9-14)	
	Display Jobs Log (page 9-14)	
	Display FAX Log (page 9-14)	

Copy (page 9-14)	Auto Paper Selection (page 9-14)		
	Auto % Priority (page 9-14)		
	Reserve Next Priority (page 9-14)		
	DP Read Action (page 9-14)		
Send (page 9-15)	Dest. Check before Send (page 9-15)		
	Entry Check for New Dest. (page 9-15)		
	Send and Forward (page 9-15)	Forward (page 9-15)	
		Destination (page 9-15)	
	Color TIFF Compression (page 9-15)		
	Default Screen (page 9-15)		
Document Box	Custom Box (page 7-3)	Add/Edit (page 7-3)	
		Default Setting (page 7-16)	
	Sub Address Box (refer to <i>Fax Operation Guide</i>)		
	Job Box (page 5-6)	Quick Copy Job Retention (page 5-8)	
		Deletion of Job Retention (page 5-11)	
	Polling Box (refer to <i>Fax Operation Guide</i>)		
FAX (refer to <i>Fax Operation Guide</i>)			
Favorites/Application	Default Screen (page 9-16)		
	Application (page 9-16)		
Internet	Proxy (page 9-16)		
Address Book/One Touch	Address Book (page 6-24)		
	One Touch Key (page 6-33)		
	Address Book Defaults	Sort	
	Print List (refer to <i>Fax Operation Guide</i>)		

User Login/Job Accounting	User Login Settings (page 9-36)	User Login (page 9-38)		
		Local User List (page 9-40)		
		ID Card Settings (page 9-50)		
		Simple login settings (page 9-51)	Simple Login (page 9-51)	
			Simple Login Setup (page 9-51)	
		Local User Authorization (page 9-45)		
		Group Authorization Set. (page 9-57)	Group Authorization (page 9-57)	
			Group List (page 9-57)	
		Obtain NW User Property (page 9-61)		
		Job Accounting Settings (page 9-63)	Job Accounting (page 9-66)	
	Job Accounting Access (page 9-68)			
	Print Accounting Report (page 9-77)			
	Total Job Accounting (page 9-75)		Printed Pages (page 9-75)	
			Scanned Pages (page 9-75)	
			FAX TX Pages (page 9-75)	
			FAX TX Time (page 9-75)	
			Counter Reset (page 9-75)	
	Each Job Accounting (page 9-75)			
	Accounting List (page 9-69)			
	Default Setting (page 9-78)		Apply Limit (page 9-78)	
			Copier/Printer Count (page 9-78)	
		Default Counter Limit (page 9-78)		
	Unknown ID Job (page 9-79)			

Printer (page 9-17)	Emulation (page 9-17)		
	Color Setting (page 9-17)		
	EcoPrint (page 9-17)		
	Override A4/Letter (page 9-17)		
	Duplex (page 9-17)		
	Copies (page 9-17)		
	Orientation (page 9-17)		
	Wide A4 (page 9-17)		
	Form Feed TimeOut (page 9-17)		
	LF Action (page 9-17)		
	CR Action (page 9-17)		
	Job Name (page 9-17)		
	User Name (page 9-17)		
	Paper Feed Mode (page 9-18)		
	Auto cassette Change (page 9-18)		
Gloss Mode (page 9-18)			
System/Network (page 9-19)	Network (page 9-19)	Host Name (page 9-19)	
		TCP/IP Settings (page 9-19)	TCP/IP (page 9-19)
			IPv4 Settings (page 9-19)
			IPv6 Settings (page 9-20)
			Bonjour (page 9-20)
			Protocol Detail (page 9-21)
		WSD Scan (page 9-22)	
		WSD Print (page 9-22)	
		Enhanced WSD (page 9-22)	
		Enhanced WSD (SSL) (page 9-22)	
		IPSec (page 9-22)	
		Secure Protocol (page 9-22)	SSL (page 9-22)
			IPP Security (page 9-22)
			HTTP Security (page 9-22)
			LDAP Security (Ext. Address Book) (page 9-23)
			LDAP Security (User Property) (page 9-23)
	SMTP Security (page 9-23)		
POP3 Security (User 1) (page 9-23)			
POP3 Security (User 2) (page 9-23)			
POP3 Security (User 3) (page 9-23)			
LAN Interface (page 9-23)			
Restart Network (page 9-23)			

	Optional Network (page 9-24)	Wireless Network (page 9-24)	Connection Status (page 9-24)
			Quick Setup (page 9-24)
			Custom Setup (page 9-24)
		Basic (page 9-25)	Host Name (page 9-25)
			TCP/IP Settings (page 9-25)
			LAN Interface (page 9-25)
			MAC Address Filter (page 9-25)
	Restart Network (page 9-25)		
	Network Interface (Send) (page 9-25)		
	Interface Block Setting (page 9-26)	USB Host (page 9-26)	
		USB Device (page 9-26)	
		USB Storage (page 9-26)	
		Optional Interface 1 (page 9-26)	
		Optional Interface 2 (page 9-26)	
		Optional Interface (page 9-26)	
	Security Level (page 9-4)		
	Restart (page 9-4)		
RAM Disk Setting (page 9-26)			
Optional Memory (page 9-26)			
Optional Function (page 11-6)			
Date/Timer/Energy Saver (page 9-27)	Date/Time (page 9-27)		
	Date Format (page 9-27)		
	Time Zone (page 9-27)		
	Auto Panel Reset (page 9-27)		
	Panel Reset Timer (page 9-27)		
	Low Power Timer (page 9-27)		
	Sleep Rules (models for Europe) (page 9-27)		
	Sleep Level (models except for Europe) (page 9-27)		
	Sleep Timer (page 9-27)		
	Auto Error Clear (page 9-27)		
	Error Clear Timer (page 9-28)		
	Unusable Time (refer to <i>Fax Operation Guide</i>)		

Adjustment/ Maintenance (page 9-28)	Density Adjustment (page 9-28)	Copy (page 9-28)		
		Send/Box (page 9-28)		
	Background Density Adj. (page 9-28)	Copy (Auto) (page 9-28)		
		Send/Box (Auto) (page 9-28)		
	Auto Color Correction (page 9-28)			
	Correcting Black Line (page 9-28)			
	Display Brightness (page 9-28)			
	Color Registration (page 9-28)			
	Drum Refresh (page 9-29)			
	Calibration (page 9-29)			
	Laser Scanner Cleaning (page 9-29)			
	Service Setting	Test Page		
		Maintenance		
		FAX Country Code		
		FAX Call Settings		
		FAX Call Settings (Europe Only)	Exchange Selection (refer to <i>Fax Operation Guide</i>)	
			PBX Setting	
Dial No. to PSTN (refer to <i>Fax Operation Guide</i>)				
Altitude Adjustment (page 9-29)				
MC (page 9-29)				
DEV-SET				
DEV-CLN				
Memory Diagnostics (page 9-29)				



1 Preface

This chapter explains the following topics:

Notice	1-2
Safety Conventions in This Guide	1-2
Environment	1-3
Precautions for Use	1-3
Laser Safety (Europe)	1-4
SAFETY OF LASER BEAM (USA)	1-5
Safety Instructions Regarding the Disconnection of Power	1-6
WARNING	1-6
Radio Tag Technology	1-6
Other precautions (for users in California, the United States)	1-6
Warranty (the United States)	1-7
Legal Restriction on Copying/Scanning	1-8
Legal and Safety Information	1-9
Legal Information	1-9
Energy Saving Control Function	1-12
Automatic 2-Sided Copy Function	1-12
Paper Recycling	1-12
Energy Star (ENERGY STAR®) Program	1-12
About this Operation Guide	1-13
Conventions in This Guide	1-13
Originals and Paper Sizes	1-15

Notice

Safety Conventions in This Guide

The sections of this guide and parts of the machine marked with symbols are safety warnings meant to protect the user, other individuals and surrounding objects, and ensure correct and safe usage of the machine. The symbols and their meanings are indicated below.

 **WARNING:** Indicates that serious injury or even death may result from insufficient attention to or incorrect compliance with the related points.

 **CAUTION:** Indicates that personal injury or mechanical damage may result from insufficient attention to or incorrect compliance with the related points.

Symbols

The  symbol indicates that the related section includes safety warnings. Specific points of attention are indicated inside the symbol.

 ... [General warning]

 ... [Warning of high temperature]

The  symbol indicates that the related section includes information on prohibited actions. Specifics of the prohibited action are indicated inside the symbol.

 ... [Warning of prohibited action]

 ... [Disassembly prohibited]

The  symbol indicates that the related section includes information on actions which must be performed. Specifics of the required action are indicated inside the symbol.

 ... [Alert of required action]

 ... [Remove the power plug from the outlet]

 ... [Always connect the machine to an outlet with a ground connection]

Please contact your service representative to order a replacement if the safety warnings in this Operation Guide are illegible or if the guide itself is missing (fee required).

NOTE

An original which resembles a bank note closely may not be copied properly in some rare cases because this machine is equipped with a counterfeiting prevention function.

Environment

The service environmental conditions are as follows:

- Temperature: 50 to 90.5 °F (10 to 32.5 °C)
- Humidity: 15 to 80 %

However, adverse environmental conditions may affect the image quality. It is recommended to use the machine at a temperature: around 60.8 to 80.6 °F or less (16 to 27 °C), humidity: around 36 to 65%. In addition, Avoid the following locations when selecting a site for the machine.

- Avoid locations near a window or with exposure to direct sunlight.
- Avoid locations with vibrations.
- Avoid locations with drastic temperature fluctuations.
- Avoid locations with direct exposure to hot or cold air.
- Avoid poorly ventilated locations.

If the floor is delicate against casters, when this machine is moved after installation, the floor material may be damaged.

During copying, some ozone is released, but the amount does not cause any ill effect to one's health. If, however, the machine is used over a long period of time in a poorly ventilated room or when making an extremely large number of copies, the smell may become unpleasant. To maintain the appropriate environment for copy work, it is suggested that the room be properly ventilated.

Precautions for Use

Cautions when handling consumables

CAUTION

Do not attempt to incinerate the toner container or the waste toner box. Dangerous sparks may cause burns.

Keep the toner container and the waste toner box out of the reach of children.

If toner happens to spill from the toner container or the waste toner box, avoid inhalation and ingestion, as well as contact with your eyes and skin.

- If you do happen to inhale toner, move to a place with fresh air and gargle thoroughly with a large amount of water. If coughing develops, contact a physician.
- If you do happen to ingest toner, rinse your mouth with water and drink 1 or 2 cups of water to dilute the contents of your stomach. If necessary, contact a physician.
- If you do happen to get toner in your eyes, flush them thoroughly with water. If there is any remaining tenderness, contact a physician.
- If toner does happen to get on your skin, wash with soap and water.

Do not attempt to force open or destroy the toner container or the waste toner box.

Other precautions

Return the exhausted toner container and waste toner box to your dealer or service representative. The collected toner container and waste toner box will be recycled or disposed in accordance with the relevant regulations.

Store the machine while avoiding exposure to direct sunlight.

Store the machine in a place where the temperature stays below 40 °C while avoiding sharp changes of temperature and humidity.

If the machine will not be used for an extended period of time, remove the paper from the cassette and the Multi Purpose (MP) Tray, return it to its original package and reseal it.

Laser Safety (Europe)

Laser radiation could be hazardous to the human body. For this reason, laser radiation emitted inside this machine is hermetically sealed within the protective housing and external cover. In the normal operation of the product by user, no radiation can leak from the machine.

This machine is classified as Class 1 laser product under IEC/EN 60825-1:2007.

Caution: Performance of procedures other than those specified in this manual may result in hazardous radiation exposure.

These labels are attached to the laser scanner unit inside the machine and are not in a user access area.

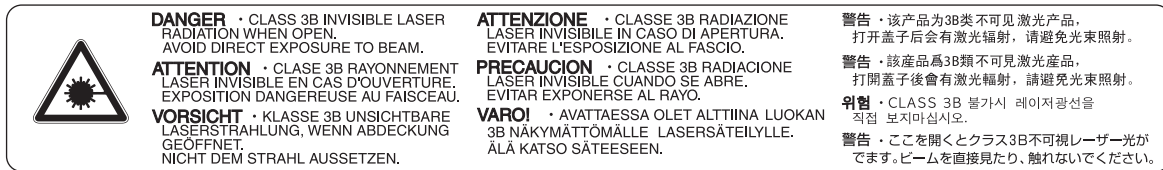

The label shown below is attached on the rear side of the machine.

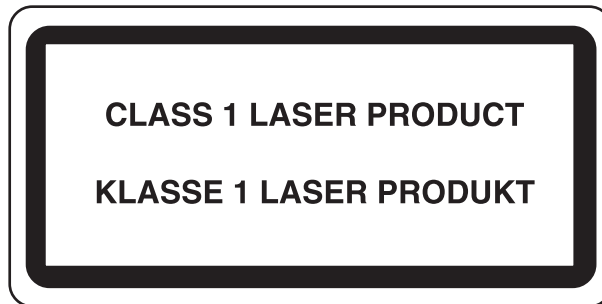

SAFETY OF LASER BEAM (USA)

1. Safety of laser beam

This machine has been certified by the manufacturer to Class 1 level under the radiation performance standards established by the U.S.DHHS (Department of Health and Human Services) in 1968. This indicates that the product is safe to use during normal operation and maintenance. The laser optical system, enclosed in a protective housing and sealed within the external covers, never permits the laser beam to escape.

2. The CDRH Act

A laser-product-related act was implemented on Aug. 2, 1976, by the Center for Devices and Radiological Health (CDRH) of the U.S. Food and Drug Administration (FDA). This act prohibits the sale of laser products in the U.S. without certification, and applies to laser products manufactured after Aug. 1, 1976. The label shown below indicates compliance with the CDRH regulations and must be attached to laser products marketed in the United States. On this machine, the label is on the rear.

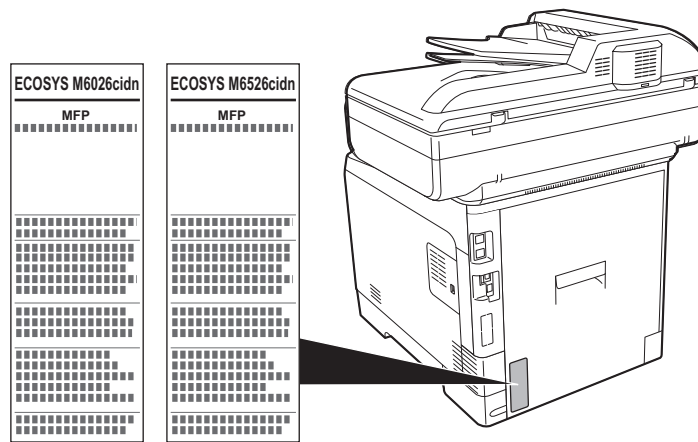

3. Optical unit

When checking the optical unit, avoid direct exposure to the laser beam, which is invisible. Shown at below is the label located on the cover of the optical unit.

	DANGER · CLASS 3B INVISIBLE LASER RADIATION WHEN OPEN. AVOID DIRECT EXPOSURE TO BEAM.	ATTENZIONE · CLASSE 3B RADIAZIONE LASER INVISIBILE IN CASO DI APERTURA. EVITARE L'ESPOSIZIONE AL FASCIO.	警告 · 该产品为3B类不可见激光产品。打开盖子后会有激光辐射，请避免光束照射。
	ATTENTION · CLASSE 3B RAYONNEMENT LASER INVISIBLE EN CAS D'OUVERTURE. EXPOSITION DANGEREUSE AU FAISCEAU.	PRECAUCION · CLASSE 3B RADIACIONE LASER INVISIBLE CUANDO SE ABRE. EVITAR EXPONERSE AL RAYO.	警告 · 該產品為3B類不可見激光產品。打開蓋子後會有激光輻射，請避免光束照射。
	VORSICHT · KLASSE 3B UNSICHTBARE LASERSTRAHLUNG, WENN ABDECKUNG GEÖFFNET. NICHT DEM STRAHL AUSSETZEN.	VARO! · AVATTAESSA OLET ALTTIINA LUOKAN 3B NÄKYMÄTTÖMÄLLE LASERSÄTEILYLLE. ÄLÄ KATSO SÄTEESEEN.	위험 · CLASS 3B 불가시 레이저광선을 직접 보지마십시오.
			警告 · ここを開くとクラス3B不可視レーザー光がでます。ビームを直接見たり、触れないでください。

4. Maintenance

For safety of the service personnel, follow the maintenance instructions in the other section of this manual.

5. Safety switch

The power to the laser unit is cut off when the front cover is opened.

Safety Instructions Regarding the Disconnection of Power

Caution: The power plug is the main isolation device! Other switches on the equipment are only functional switches and are not suitable for isolating the equipment from the power source.

Attention: Le débranchement de la fiche secteur est le seul moyen de mettre l'appareil hors tension. Les interrupteurs sur l'appareil ne sont que des interrupteurs de fonctionnement: ils ne mettent pas l'appareil hors tension.

WARNING

This equipment has been tested and found to comply with the limits for a Class B digital device, pursuant to Part 15 and Part 18 of the FCC Rules. These limits are designed to provide reasonable protection against harmful interference in a residential installation. This equipment generates, uses and can radiate radio frequency energy and, if not installed and used in accordance with the instructions, may cause harmful interference to radio communications. However, there is no guarantee that interference will not occur in a particular installation. If this equipment does cause harmful interference to radio or television reception, which can be determined by turning the equipment off and on, the user is encouraged to try to correct the interference by one or more of the following measures:

- Reorient or relocate the receiving antenna.
- Increase the separation between the equipment and receiver.
- Connect the equipment into an outlet on a circuit different from that to which the receiver is connected.
- Consult the dealer or an experienced radio/TV technician for help.
- The use of a non-shielded interface cable with the referenced device is prohibited.

CAUTION — The changes or modifications not expressly approved by the party responsible for compliance could void the user's authority to operate the equipment.

This device contains the module, which complies with Part 15 of FCC Rules and RSS-Gen of IC Rules.

Operation is subject to the following two conditions; (1) this device may not cause interference, and (2) this device must accept any interference, including interference that may cause undesired operation of the device.

Radio Tag Technology

In some countries the radio tag technology used in this equipment to identify the toner container may be subject to authorization and the use of this equipment may consequently be restricted.

Other precautions (for users in California, the United States)

This product contains a CR Coin Lithium Battery which contains Perchlorate Material - special handling may apply. See www.dtsc.ca.gov/hazardouswaste/perchlorate.

Warranty (the United States)

ECOSYS M6026cidn/ECOSYS M6526cidn MULTIFUNCTIONAL PRODUCT LIMITED WARRANTY

KYOCERA Document Solutions America, Inc. and KYOCERA Document Solutions Canada, Ltd. (both referred to as "KYOCERA") warrant the Customer's new Multifunctional Product (referred to as "MFP"), and the new accessories installed with the initial installation of the MFP, against any defects in material and workmanship for a period of one year, or 200,000 copies/prints from date of installation, whichever first occurs. In the event the MFP or an accessory is found to be defective within the warranty period, KYOCERA's only obligation and the Customer's exclusive remedy shall be replacement of any defective parts. KYOCERA shall have no obligation to furnish labor.

This warranty covers Maintenance Kits and the components of Maintenance Kits included with the original MFP for a period of one year or 200,000 copies/prints, whichever first occurs. Maintenance Kits consist of the developing unit, the drum unit, the transfer belt, and the fixing unit. Replacement Maintenance Kits have a 90 day Limited Warranty.

This warranty is valid only for the original retail purchaser (referred to as the "Customer") of a new KYOCERA MFP in the United States of America or Canada, based upon the country of purchase.

In order to obtain performance of this warranty, the Customer must immediately notify the Authorized KYOCERA Dealer from whom the product was purchased. If the KYOCERA Dealer is not able to provide service, write to KYOCERA at the address below for the name and address of the Authorized KYOCERA Dealer in your area, or check KYOCERA's website at <http://www.kyoceradocumentsolutions.com> for KYOCERA Document Solutions America, Inc. or <http://www.kyoceradocumentsolutions.ca> for KYOCERA Document Solutions Canada, Ltd.

This warranty does not cover MFPs or accessories which: (a) have become damaged due to operator negligence, misuse, accidents, improper storage or unusual physical or electrical stress, (b) have used parts or supplies which are not genuine KYOCERA brand parts or supplies, (c) have been installed or serviced by a technician not employed by KYOCERA or an Authorized KYOCERA Dealer, or (d) have had the serial number modified, altered, or removed.

This warranty gives the Customer specific legal rights. The Customer may also have other rights, which vary from state to state, or province to province. Neither the seller, nor any other person, is authorized to extend the time period or expand this warranty on behalf of KYOCERA.

THIS WARRANTY IS MADE IN LIEU OF ALL OTHER WARRANTIES AND CONDITIONS, EXPRESS OR IMPLIED, AND KYOCERA SPECIFICALLY DISCLAIMS ANY IMPLIED WARRANTY OR CONDITION OF MERCHANTABILITY OR FITNESS FOR A PARTICULAR PURPOSE. THIS WARRANTY SHALL NOT EXTEND TO, AND KYOCERA SHALL NOT BE LIABLE FOR, ANY INCIDENTAL OR CONSEQUENTIAL DAMAGES WHICH MAY ARISE OUT OF THE USE OF, OR INABILITY TO USE, THE MFP.

KYOCERA Document Solutions America, Inc.

225 Sand Road, P.O. Box 40008
Fairfield, New Jersey 07004-0008, USA

KYOCERA Document Solutions Canada, Ltd.

6120 Kestrel Rd., Mississauga, ON L5T 1S8,
Canada

Legal Restriction on Copying/Scanning

It may be prohibited to copy/scan copyrighted material without permission of the copyright owner.

Copying/Scanning the following items is prohibited and may be penalized by law. It may not be limited to these items. Do not knowingly copy/scan the items that are not to be copied/scanned.

- Paper money
- Bank note
- Securities
- Stamp
- Passport
- Certificate

Local laws and regulations may prohibit or restrict copying/scanning of other items not mentioned above.

Legal and Safety Information

Legal Information

Copying or other reproduction of all or part of this guide without the prior written consent of KYOCERA Document Solutions Inc. is prohibited.

Regarding Trade Names

- PRESCRIBE and ECOSYS are trademarks of Kyocera Corporation.
- KPDL is a trademark of Kyocera Corporation.
- Microsoft, MS-DOS and Windows are registered trademarks of Microsoft Corporation in the U.S.A. and/or other countries.
- PCL is a trademark of Hewlett-Packard Company.
- Adobe Acrobat, Adobe Reader and PostScript are trademarks of Adobe Systems, Incorporated.
- Ethernet is a registered trademark of Xerox Corporation.
- IBM and IBM PC/AT are trademarks of International Business Machines Corporation.
- Power PC is a trademark of IBM in the U.S.A. and/or other countries.
- Bonjour, Macintosh, and Mac OS are trademarks of Apple Inc., registered in the U.S. and other countries.
- All European language fonts installed in this machine are used under licensing agreement with Monotype Imaging Inc.
- Helvetica, Palatino and Times are registered trademarks of Linotype GmbH.
- ITC Avant Garde Gothic, ITC Bookman, ITC ZapfChancery and ITC ZapfDingbats are registered trademarks of International Typeface Corporation.
- UFST™ MicroType® fonts by Monotype Imaging Inc. are installed in this machine.
- This machine contains the NF module developed by ACCESS Co., Ltd.
- This machine contains the software having modules developed by Independent JPEG Group.
- ThinPrint is a trademark of ThinPrint GmbH in Germany and other countries.

All other brands and product names are registered trademarks or trademarks designations ™ and ® will not be used in this Operation Guide.

GPL/LGPL

This product contains GPL (<http://www.gnu.org/licenses/gpl.html>) and/or LGPL (<http://www.gnu.org/licenses/lgpl.html>) software as part of its firmware. You can get the source code, and you are permitted to copy, redistribute and modify it under the terms of GPL/LGPL. For further information including availability of the source code, visit <http://www.kyoceradocumentsolutions.com/gpl/>.

Open SSL License

Copyright (c) 1998-2006 The OpenSSL Project. All rights reserved.

Redistribution and use in source and binary forms, with or without modification, are permitted provided that the following conditions are met:

1. Redistributions of source code must retain the above copyright notice, this list of conditions and the following disclaimer.
2. Redistributions in binary form must reproduce the above copyright notice, this list of conditions and the following disclaimer in the documentation and/or other materials provided with the distribution.

3. All advertising materials mentioning features or use of this software must display the following acknowledgment:
“This product includes software developed by the OpenSSL Project for use in the OpenSSL Toolkit.
(<http://www.openssl.org/>)”
4. The names “OpenSSL Toolkit” and “OpenSSL Project” must not be used to endorse or promote products derived from this software without prior written permission.
For written permission, please contact openssl-core@openssl.org.
5. Products derived from this software may not be called “OpenSSL” nor may “OpenSSL” appear in their names without prior written permission of the OpenSSL Project.
6. Redistributions of any form whatsoever must retain the following acknowledgment: “This product includes software developed by the OpenSSL Project for use in the OpenSSL Toolkit (<http://www.openssl.org/>)”

THIS SOFTWARE IS PROVIDED BY THE OpenSSL PROJECT “AS IS” AND ANY EXPRESSED OR IMPLIED WARRANTIES, INCLUDING, BUT NOT LIMITED TO, THE IMPLIED WARRANTIES OF MERCHANTABILITY AND FITNESS FOR A PARTICULAR PURPOSE ARE DISCLAIMED. IN NO EVENT SHALL THE OpenSSL PROJECT OR ITS CONTRIBUTORS BE LIABLE FOR ANY DIRECT, INDIRECT, INCIDENTAL, SPECIAL, EXEMPLARY, OR CONSEQUENTIAL DAMAGES (INCLUDING, BUT NOT LIMITED TO, PROCUREMENT OF SUBSTITUTE GOODS OR SERVICES; LOSS OF USE, DATA, OR PROFITS; OR BUSINESS INTERRUPTION) HOWEVER CAUSED AND ON ANY THEORY OF LIABILITY, WHETHER IN CONTRACT, STRICT LIABILITY, OR TORT (INCLUDING NEGLIGENCE OR OTHERWISE) ARISING IN ANY WAY OUT OF THE USE OF THIS SOFTWARE, EVEN IF ADVISED OF THE POSSIBILITY OF SUCH DAMAGE.

Original SSLeay License

Copyright (C) 1995-1998 Eric Young (eay@cryptsoft.com) All rights reserved.

This package is an SSL implementation written by Eric Young (eay@cryptsoft.com). The implementation was written so as to conform with Netscapes SSL.

This library is free for commercial and non-commercial use as long as the following conditions are aheared to. The following conditions apply to all code found in this distribution, be it the RC4, RSA, lhash, DES, etc., code; not just the SSL code. The SSL documentation included with this distribution is covered by the same copyright terms except that the holder is Tim Hudson (tjh@cryptsoft.com).

Copyright remains Eric Young's, and as such any Copyright notices in the code are not to be removed.

If this package is used in a product, Eric Young should be given attribution as the author of the parts of the library used.

This can be in the form of a textual message at program startup or in documentation (online or textual) provided with the package.

Redistribution and use in source and binary forms, with or without modification, are permitted provided that the following conditions are met:

1. Redistributions of source code must retain the copyright notice, this list of conditions and the following disclaimer.
2. Redistributions in binary form must reproduce the above copyright notice, this list of conditions and the following disclaimer in the documentation and/or other materials provided with the distribution.
3. All advertising materials mentioning features or use of this software must display the following acknowledgement:
“This product includes cryptographic software written by Eric Young (eay@cryptsoft.com)”
The word ‘cryptographic’ can be left out if the rouines from the library being used are not cryptographic related :-).
4. If you include any Windows specific code (or a derivative thereof) from the apps directory (application code) you must include an acknowledgement: “This product includes software written by Tim Hudson (tjh@cryptsoft.com)”

THIS SOFTWARE IS PROVIDED BY ERIC YOUNG “AS IS” AND ANY EXPRESS OR IMPLIED WARRANTIES, INCLUDING, BUT NOT LIMITED TO, THE IMPLIED WARRANTIES OF MERCHANTABILITY AND FITNESS FOR A PARTICULAR PURPOSE ARE DISCLAIMED. IN NO EVENT SHALL THE AUTHOR OR CONTRIBUTORS BE LIABLE FOR ANY DIRECT, INDIRECT, INCIDENTAL, SPECIAL, EXEMPLARY, OR CONSEQUENTIAL DAMAGES (INCLUDING, BUT NOT LIMITED TO, PROCUREMENT OF SUBSTITUTE GOODS OR SERVICES; LOSS OF USE, DATA, OR PROFITS; OR BUSINESS INTERRUPTION) HOWEVER CAUSED AND ON ANY THEORY OF LIABILITY, WHETHER IN CONTRACT, STRICT LIABILITY, OR TORT (INCLUDING NEGLIGENCE OR OTHERWISE) ARISING IN ANY WAY OUT OF THE USE OF THIS SOFTWARE, EVEN IF ADVISED OF THE POSSIBILITY OF SUCH DAMAGE.

The licence and distribution terms for any publically available version or derivative of this code cannot be changed. i.e. this code cannot simply be copied and put under another distribution licence [including the GNU Public Licence.]

Monotype Imaging License Agreement

- 1 *Software* shall mean the digitally encoded, machine readable, scalable outline data as encoded in a special format as well as the UFST Software.
- 2 You agree to accept a non-exclusive license to use the Software to reproduce and display weights, styles and versions of letters, numerals, characters and symbols (*Typefaces*) solely for your own customary business or personal purposes at the address stated on the registration card you return to Monotype Imaging. Under the terms of this License Agreement, you have the right to use the Fonts on up to three printers. If you need to have access to the fonts on more than three printers, you need to acquire a multiuser license agreement which can be obtained from Monotype Imaging. Monotype Imaging retains all rights, title and interest to the Software and Typefaces and no rights are granted to you other than a License to use the Software on the terms expressly set forth in this Agreement.
- 3 To protect proprietary rights of Monotype Imaging, you agree to maintain the Software and other proprietary information concerning the Typefaces in strict confidence and to establish reasonable procedures regulating access to and use of the Software and Typefaces.
- 4 You agree not to duplicate or copy the Software or Typefaces, except that you may make one backup copy. You agree that any such copy shall contain the same proprietary notices as those appearing on the original.
- 5 This License shall continue until the last use of the Software and Typefaces, unless sooner terminated. This License may be terminated by Monotype Imaging if you fail to comply with the terms of this License and such failure is not remedied within thirty (30) days after notice from Monotype Imaging. When this License expires or is terminated, you shall either return to Monotype Imaging or destroy all copies of the Software and Typefaces and documentation as requested.
- 6 You agree that you will not modify, alter, disassemble, decrypt, reverse engineer or decompile the Software.
- 7 Monotype Imaging warrants that for ninety (90) days after delivery, the Software will perform in accordance with Monotype Imaging-published specifications, and the diskette will be free from defects in material and workmanship. Monotype Imaging does not warrant that the Software is free from all bugs, errors and omissions.

The parties agree that all other warranties, expressed or implied, including warranties of fitness for a particular purpose and merchantability, are excluded.
- 8 Your exclusive remedy and the sole liability of Monotype Imaging in connection with the Software and Typefaces is repair or replacement of defective parts, upon their return to Monotype Imaging.

In no event will Monotype Imaging be liable for lost profits, lost data, or any other incidental or consequential damages, or any damages caused by abuse or misapplication of the Software and Typefaces.
- 9 Massachusetts U.S.A. law governs this Agreement.
- 10 You shall not sublicense, sell, lease, or otherwise transfer the Software and/or Typefaces without the prior written consent of Monotype Imaging.
- 11 Use, duplication or disclosure by the Government is subject to restrictions as set forth in the Rights in Technical Data and Computer Software clause at FAR 252-227-7013, subdivision (b)(3)(ii) or subparagraph (c)(1)(ii), as appropriate. Further use, duplication or disclosure is subject to restrictions applicable to restricted rights software as set forth in FAR 52.227-19 (c)(2).
- 12 You acknowledge that you have read this Agreement, understand it, and agree to be bound by its terms and conditions. Neither party shall be bound by any statement or representation not contained in this Agreement. No change in this Agreement is effective unless written and signed by properly authorized representatives of each party. By opening this diskette package, you agree to accept the terms and conditions of this Agreement.

Energy Saving Control Function

The device comes equipped with a **Low Power Mode** where energy consumption is reduced after a certain amount of time elapses since the device was last used, as well as a **Sleep** where printer and fax functions remain in a waiting state but power consumption is still reduced to a minimum when there is no activity with the device within a set amount of time.

Low Power Mode

The device automatically enters Low Power Mode when 1 minute has passed since the device was last used. The amount of time of no activity that must pass before Low Power Mode is activated may be lengthened. For more information refer to *Low Power Mode on page 2-27*.

Sleep

The device automatically enters Sleep when 15 minutes have passed since the device was last used. The amount of time of no activity that must pass before Sleep is activated may be lengthened. For more information refer to *Sleep and Auto Sleep on page 2-28*.

Automatic 2-Sided Copy Function

This device includes 2-sided copying as a standard function. For example, by copying two 1-sided originals onto a single sheet of paper as a 2-sided copy, it is possible to lower the amount of paper used. For more information refer to *Duplex on page 4-7*.

Paper Recycling

This device supports the recycled paper which reduces the load on the environment. Your sales or service representative can provide information about recommended paper types.

Energy Star (ENERGY STAR®) Program



We have determined as a company participating in ENERGY STAR that this product has earned the ENERGY STAR.



About this Operation Guide

This Operation Guide contains the following chapters.







Chapter		Contents
1	Preface	Includes information about operating precautions, trademarks, and this manual.
2	Preparation before Use	Provides information about part names, connecting cables, and setting up and configuring the machine.
3	Common Operations	Explains overall machine operation, including loading paper and originals and logging in and out.
4	Copying	Describes the functions you can use when copying.
5	Printing	Provides information about functionality that is available when using the machine as a printer.
6	Sending	Describes the functions you can use when sending originals.
7	Document Box	Provides a basic guide to using document boxes.
8	Status / Job Cancel	Explains how to check the job status and job history and how to cancel jobs being printed or waiting to print. Also explains how to check the remaining paper and device status and how to cancel fax transmission.
9	Setup, Registration, and User Management	Explains system menu functionality related to overall machine operation, job accounting, and user management.
10	Troubleshooting	Explains how to respond to error indications such as when the machine runs out of toner and problems such as paper jams.
11	Appendix	Explains how to enter characters, and lists the machine specifications. Introduces the convenient optional equipment available for this machine. Provides information on media types and paper sizes. Also includes a glossary of terms.

Conventions in This Guide

The following conventions are used depending on the nature of the description.

Convention	Description	Example
Bold	Indicates the operation panel keys or a computer screen.	Press the Start key.
[Regular]	Indicates the touch panel keys.	Press [OK].
<i>Italic</i>	Indicates a message displayed on the touch panel.	<i>Ready to copy</i> is displayed.
	Used to emphasize a key word, phrase or references to additional information.	For more information refer to <i>Sleep and Auto Sleep</i> on page 2-28.
NOTE	Indicates supplemental information or operations for reference.	 NOTE
IMPORTANT	Indicates items that are required or prohibited so as to avoid problems.	 IMPORTANT
CAUTION	Indicates what must be observed to prevent injury or machine breakdown and how to deal with it.	 CAUTION

Job types for which each function can be set are shown with icons.

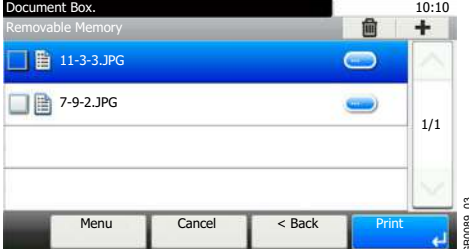
Icon	Description	Icon	Description
	<p>This function can be set while copying a document.</p>  <p>Copy Screen</p>		<p>The function can be used when printing from a custom box.</p>  <p>Custom box screen</p>
	<p>This function can be set while sending a document.</p>  <p>Send Screen</p>		<p>The function can be used when saving to or printing from removable memory such as a USB memory stick.</p>  <p>Custom box screen</p>

In this guide, steps where touch panel keys are used are outlined in red.

E.g.) Select [Zoom].

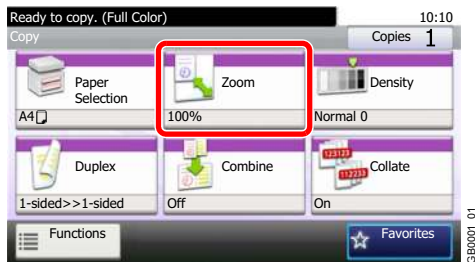

Procedures consisting of a series of operation panel and/or touch panel operations are numbered as follows:

E.g.) Select [Functions] and then [EcoPrint].





Originals and Paper Sizes

This section explains the notation used in this guide when referring to sizes of originals or paper sizes.

Icons on the Touch Panel

The following icons are used to indicate originals and paper placement directions on the touch panel.

Originals	Paper
 <p data-bbox="568 591 775 618">Horizontal direction</p>	 <p data-bbox="1139 591 1315 618">Vertical direction</p>

2 Preparation before Use

This chapter explains the following topics:

Part Names	2-2
Machine	2-2
Operation Panel	2-6
Touch Panel	2-7
Determining the Connection Method and Preparing Cables	2-8
Connection Example	2-8
Preparing Necessary Cables	2-9
Connecting Cables	2-10
Connecting LAN Cable	2-10
Connecting USB Cable	2-11
Connecting the Power Cable	2-11
Power On/Off	2-13
Power On	2-13
Power Off	2-13
Installing Software	2-15
Software on DVD (Windows)	2-15
Installing Printer Driver in Windows	2-16
Uninstalling the Software	2-21
Installing Printer Driver in Macintosh	2-21
Setting TWAIN Driver	2-24
Setting WIA Driver	2-26
Energy Saver function	2-27
Low Power Mode	2-27
Sleep and Auto Sleep	2-28
Machine Setup Wizard	2-29
Command Center RX	2-30
Accessing Command Center RX	2-31
Changing Security Settings	2-32
Changing Device Information	2-33
E-mail settings	2-34
Registering Destinations	2-37
Registering a Custom Box	2-38
Printing a document stored in a Custom Box	2-39

Part Names

Machine

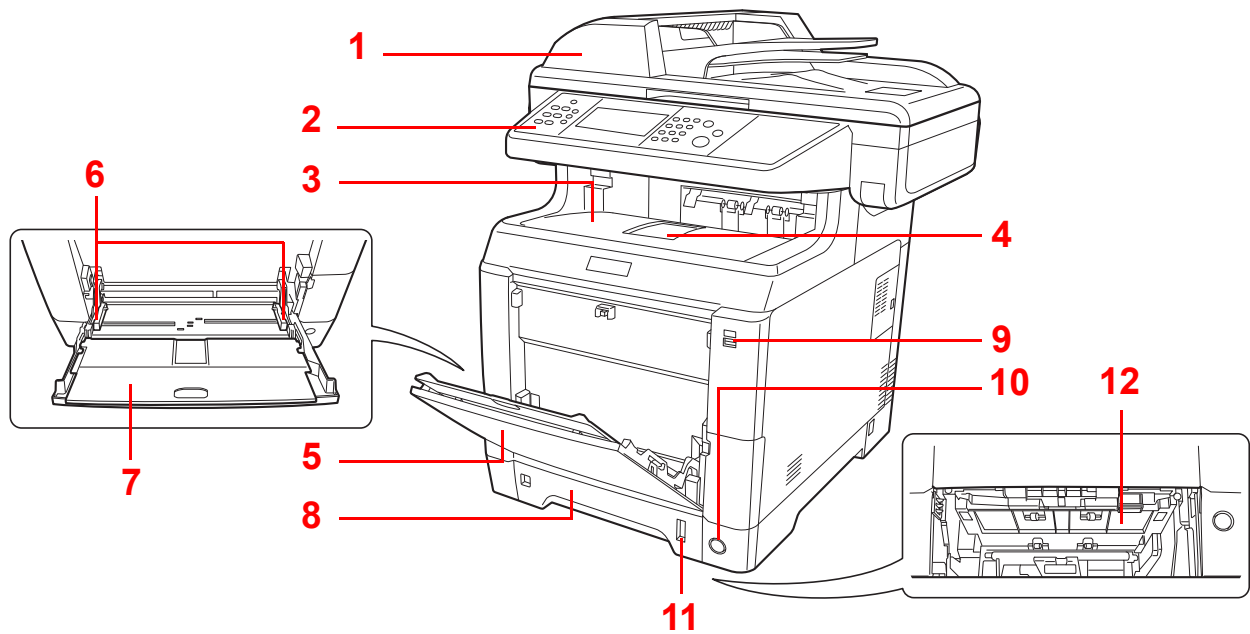

- 1 Document Processor
- 2 Operation Panel
- 3 Inner Tray
- 4 Paper Stopper
- 5 Multi Purpose Tray (MP Tray)
- 6 Paper Width Guides
- 7 Support Tray Section of the Multi Purpose Tray
- 8 Cassette 1
- 9 USB Memory Slot
- 10 Main Power Switch
- 11 Paper Gauge
- 12 Lower Feed Cover

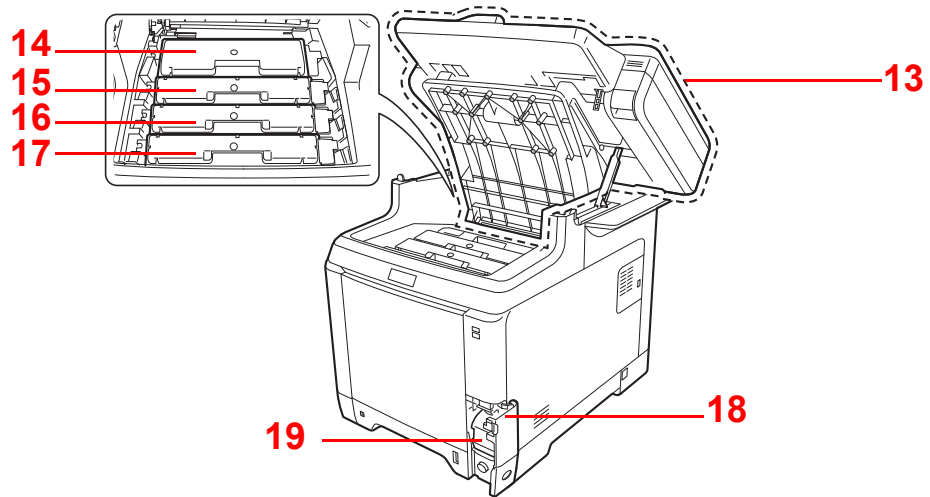

13 Top Cover

14 Black Toner Container (K)

15 Magenta Toner Container (M)

16 Cyan Toner Container (C)

17 Yellow Toner Container (Y)

18 Waste Toner Cover

19 Waste Toner Box

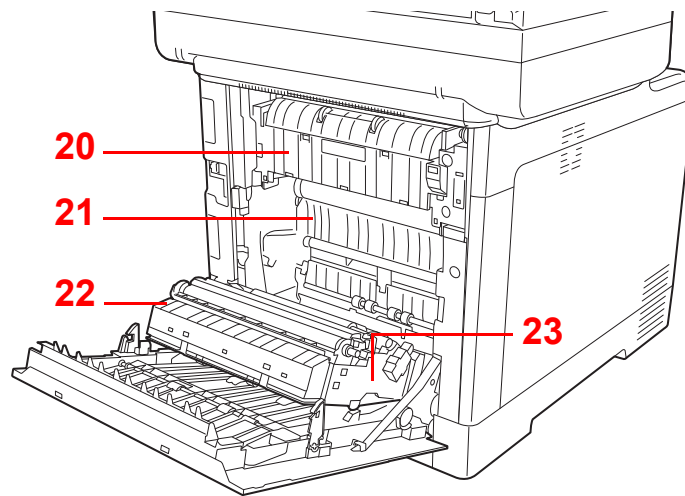

20 Fuser Cover

21 Paper Transfer Unit

22 Paper Ramp

23 Duplex Unit

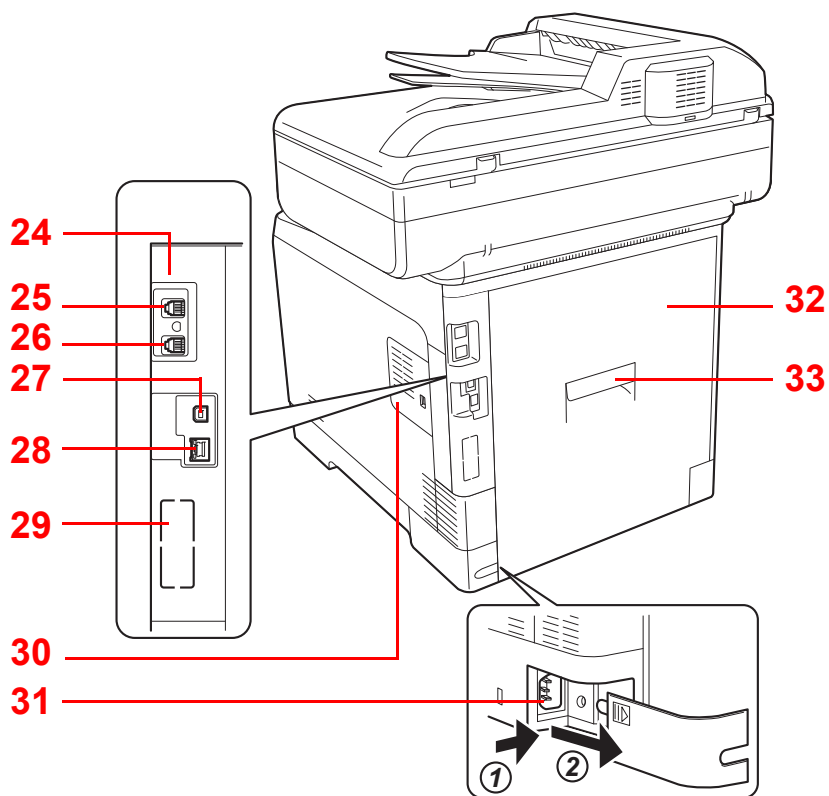

24 Option Interface Slot 1*

25 LINE connector*

26 TEL connector*

27 USB Interface Connector

28 Network Interface Connector/Indicators

29 Option Interface Slot 2

30 Right Cover

31 Power Cord Connector

32 Rear Cover

33 Rear Cover Lever

* Only on products with the fax function installed.

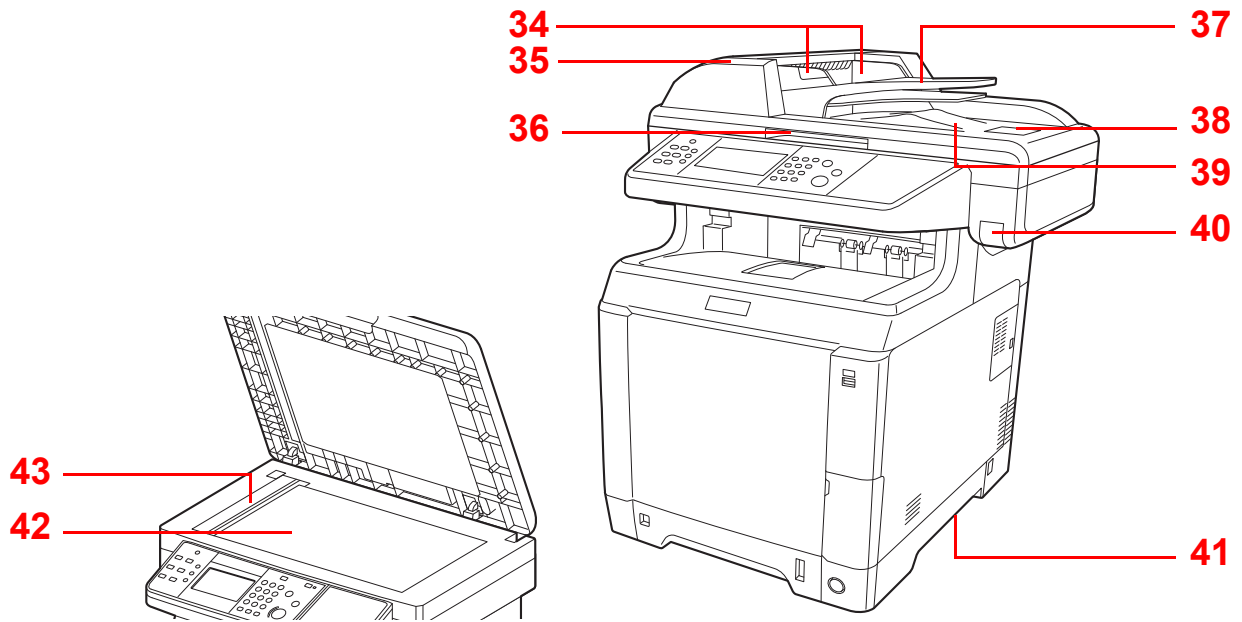

34 Original Width Guides

35 Document Processor Cover

36 Document Processor Open/Close Handle*

37 Original Table

38 Original Stopper

39 Original Eject Table

40 Top Cover Lever*

41 Handholds

42 Platen

43 Slit Glass

* To prevent toppling, the top cover and document processor cannot be opened at the same time.

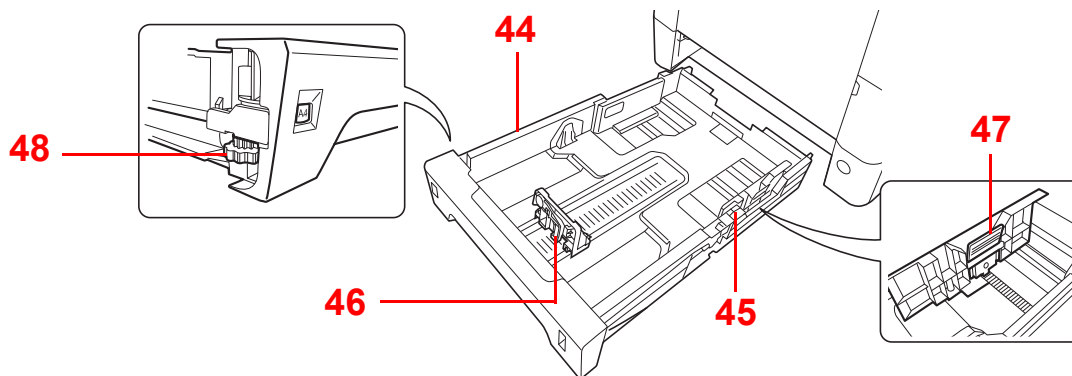

44 Cassette 1













45 Paper Width Guides

46 Paper Length Guide

47 Paper Width Adjusting Tab

48 Paper Size Dial

Operation Panel

		Displays the System Menu/Counter screen.		Logout 	Ends operation (logs out) on the Administration screen.
Status/Job Cancel 	Displays the Status/Job Cancel screen.	Copy 	Displays the Copy screen.	Energy Saver 	Puts the machine into Sleep Mode. Recovers from Sleep if in Sleep Mode.
Favorites/Application 	Displays the Favorites screen. When using an application, displays the application screen.	Send 	Displays the screen for sending.		Lit when the machine's main power is on.
Document Box 	Displays the Document Box screen.	FAX 	Displays the FAX screen.		
  	Select the color mode. Auto Color: Automatically recognizes whether a document is color or black & white and then scans the document. Full Color: Scans all documents in full color. Black & White: Scans all documents in black & white.				









Touch panel. Displays buttons for configuring machine settings.

Processing: Blinks while printing or sending.

Memory: Blinks while the machine is accessing the fax memory or USB memory (generalpurpose item).

Attention: Lights or blinks when an error occurs and a job is stopped.

	Numeric keys. Enter numbers and symbols.	Clear 	Clears entered numbers and characters.	Reset 	Returns settings to their default states.
		Quick No. Search 	Specifies registered information such as address numbers and user IDs by number.	Stop 	Cancels or pauses the printing job in progress.
		Enter 	Finalizes numeric key entry, and finalizes screen during setting of functions. Operates linked with the on-screen [OK].	Start 	Starts copying and scanning operations and processing for setting operations.

Touch Panel

Displays the status of the equipment as well as necessary operation messages.

Displays available functions.

Configures more advanced function settings.

Displays Favorites.

Displays shortcuts.

Displays the status of the equipment as well as necessary operation messages.

Displays available functions and settings.

Return to the previous screen.

Registers functions as shortcuts.

Displays the time and number of copies.

Scrolls up and down when the list of values cannot be displayed in its entirety on a single screen.

Determining the Connection Method and Preparing Cables

Check the method to connect the equipment to a PC or network, and prepare the necessary cables for your environment.

Connection Example

Determine the method to connect the equipment to a PC or network by referring to the illustration below.

Connecting a scanner to your PC network with a network cable (1000BASE-T, 100BASE-TX or 10BASE-T)

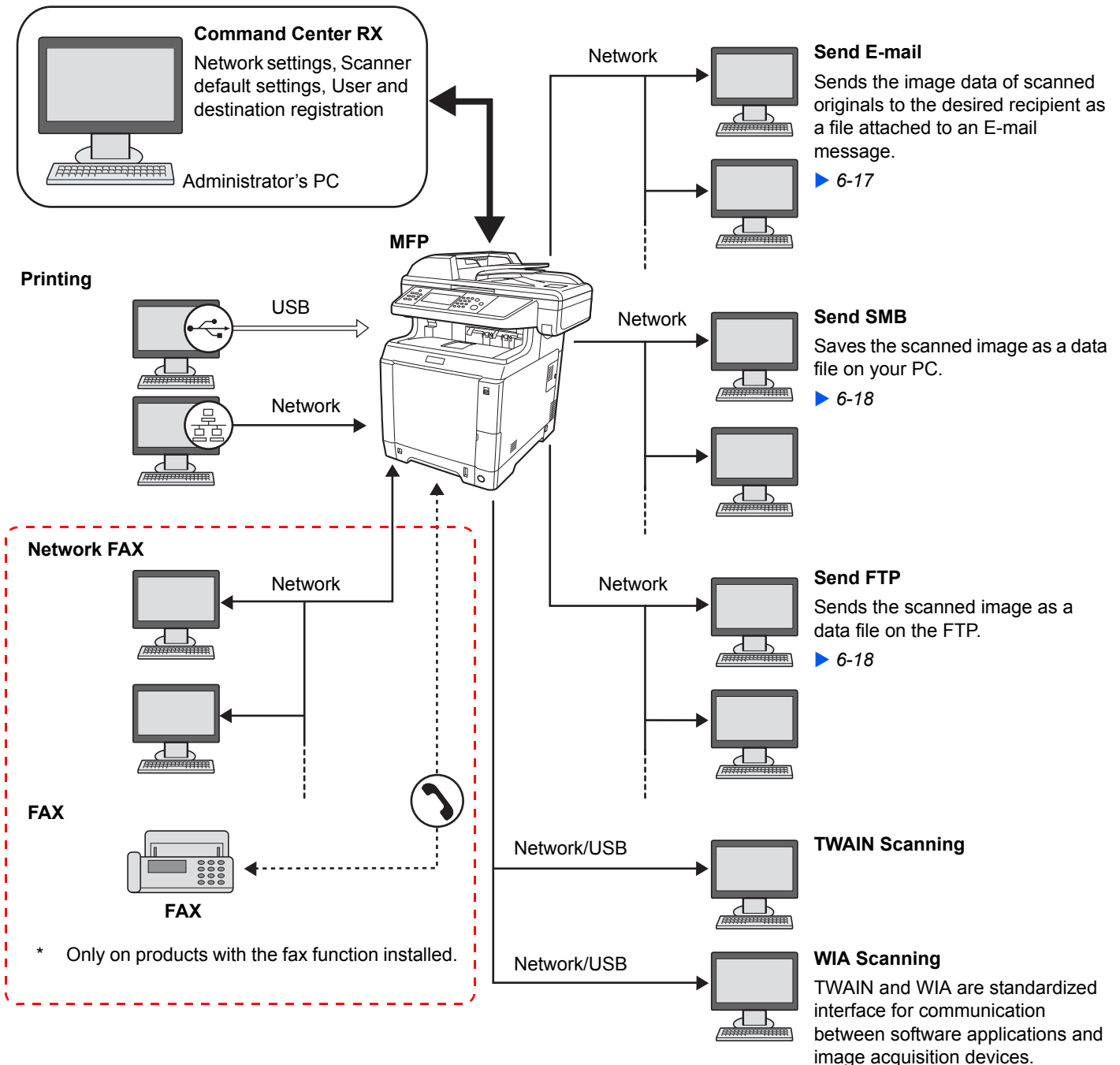

Preparing Necessary Cables

Prepare the necessary cables according to the interface you use.

Connection Environment	Function	Necessary Cable
Connect a LAN cable to the machine.	<ul style="list-style-type: none">• Printer• Scanner (Send E-mail/Send SMB/Send FTP)• Scanner (TWAIN/WIA)	LAN (10Base-T, 100Base-TX, or 1000BASE-T Shielded)
Connect a USB cable to the machine.	<ul style="list-style-type: none">• Printer• Scanner (TWAIN/WIA)	USB2.0 compatible cable (Hi-Speed USB compliant, Max. 5.0 m, Shielded)

Connecting Cables

Connecting LAN Cable

The equipment can be connected with a network cable and used as a network printer or network scanner.

1 Power Off.

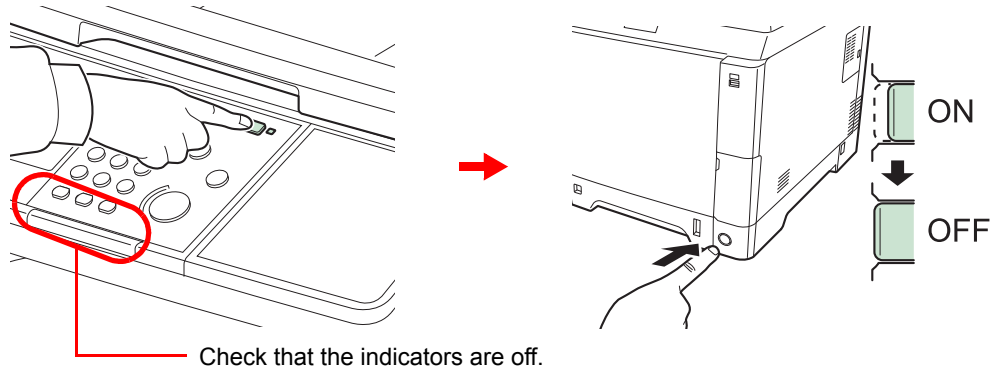

2 Connect the machine.

1 Connect the LAN cable to the network interface located on right side of the body.

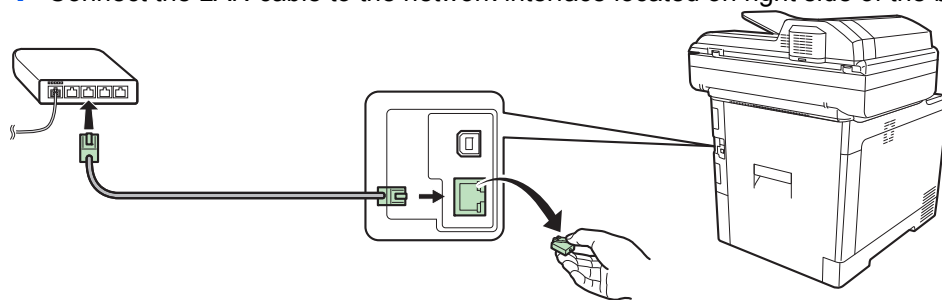

2 Connect the other end of the cable to the hub.

3 Set up the machine.

Configure the network settings.

 For details, refer to *Machine Setup Wizard* on page 2-29.

Connecting USB Cable

The equipment can be connected with a USB cable and used as a printer or scanner in an environment where there is no network.

1 Power Off.

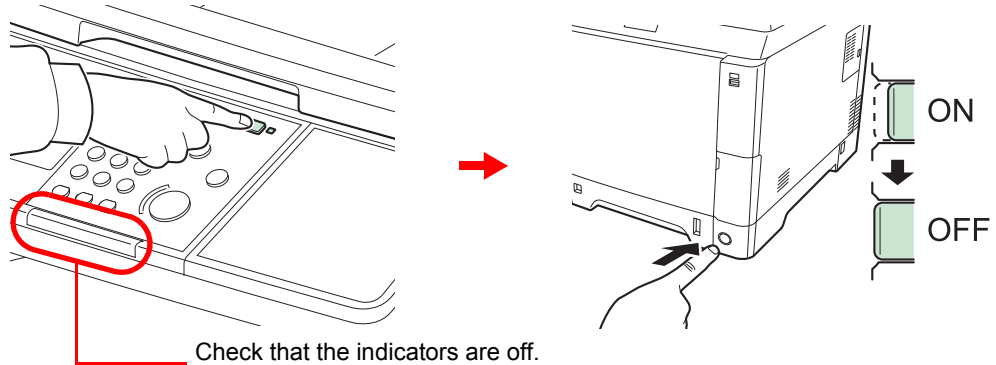

2 Connect the machine.

- 1 Connect the USB cable to the appropriate interface located on the right side of the body.

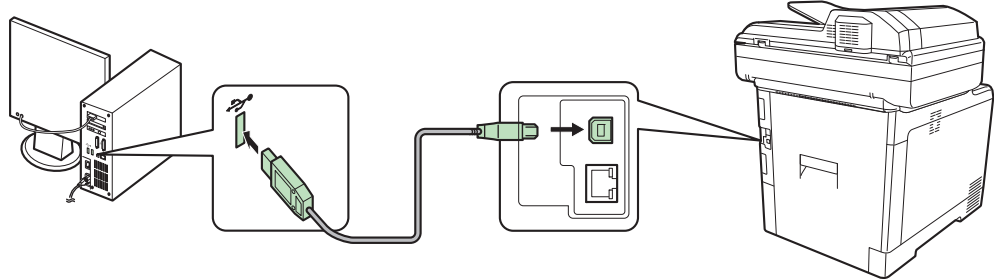

- 2 Connect the other end of the cable to the PC.

Connecting the Power Cable

- 1 Remove the Power Cord Connector Cover.

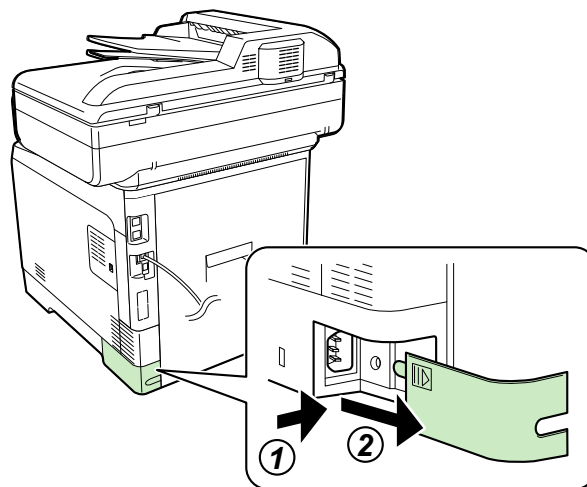

- 2 Connect one end of the supplied power cable to the machine and the other end to a power outlet.

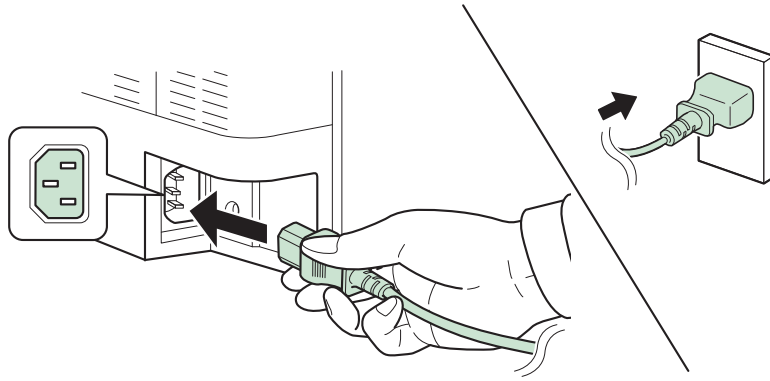

✔ IMPORTANT

Only use the power cable that comes with the machine.

- 3 Replace the Power Cord Connector Cover.

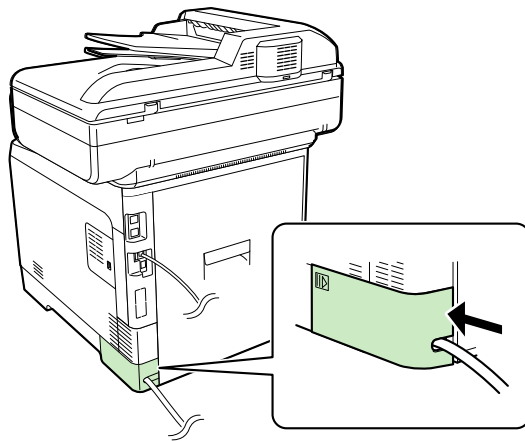

Power On/Off

Power On

When the main power indicator is lit... (Recovery from sleep)

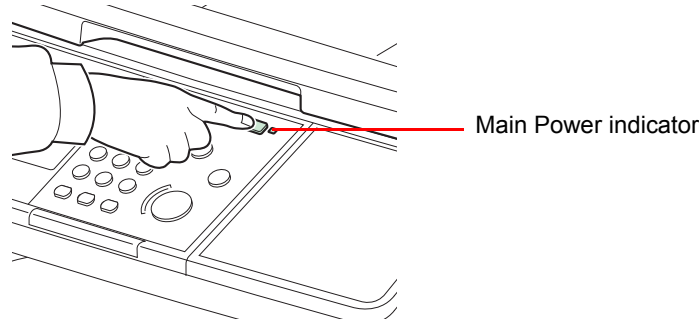

Press the **Energy Saver** key.

When the main power indicator is off...

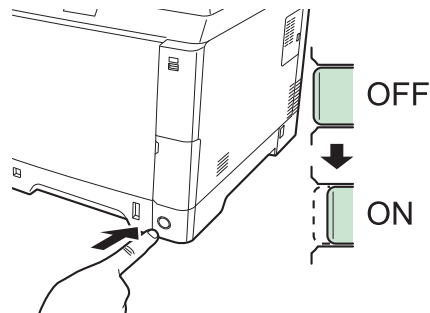

Turn the main power switch on.

✔ **IMPORTANT**

When turning off the main power switch, do not turn on the main power switch again immediately. Wait more than 5 seconds, and then turn on the main power switch.

Power Off

When not turning off the main power switch (sleep)

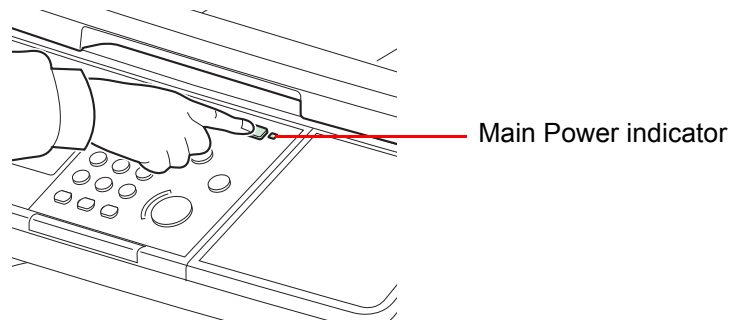

Press the **Energy Saver** key. The **Energy Saver** key light will go out, and the Main Power indicator will light up.

When turning off the main power switch

Note that when the main power switch is turned off, the machine will be unable to automatically receive print data from computers or faxes.

1 Press the Energy Saver key.

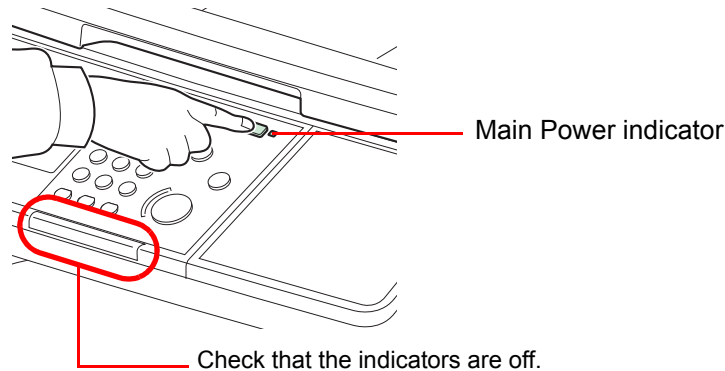

Verify that the **Energy Saver** key light has gone out and that the Main Power indicator is lit up.

2 Turn the main power switch off.

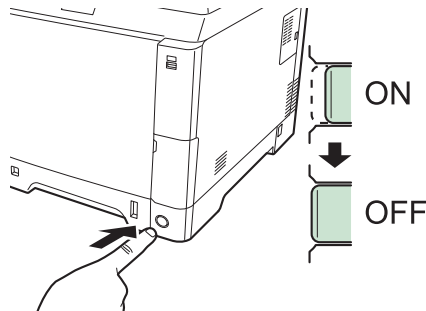

NOTE

When the **Processing** indicator or **Memory** indicator is lit up, the machine is operating. Turning off the main power switch while the machine is operating may cause it to malfunction.

In case of not using the machine for an extended period of time



CAUTION

If this machine will be left unused for an extended period (e.g. overnight), turn it off at the main power switch. If the machine will not be used for an even longer period of time (e.g. vacation), remove the power plug from the outlet as a safety precaution. If using the products equipped with the fax function, note that turning the machine off at the main power switch disables fax transmission and reception.



IMPORTANT

Remove paper from the cassettes and seal it in the paper storage bag to protect it from humidity.

Installing Software

Install appropriate software on your PC from the included DVD (Product Library) if you want to use the printer function of this machine or perform TWAIN / WIA transmission or Network FAX transmission from your PC.

Software on DVD (Windows)

You can use either **Express Install** or **Custom Install** can be selected for the installation method. **Express Install** is the standard installation method. To install components that cannot be installed by **Express Install**, use **Custom Install**. For details, refer to Custom Installation in the *Custom Install on page 2-18*.

Software	Description	Installation method	
		Express Install	Custom Install
KX DRIVER	This driver enables files on a computer to be printed by the machine. Multiple page description languages (PCL XL, KPDL, etc.) are supported by a single driver. This printer driver allows you to take full advantage of the features of the machine. Use this driver to create PDF files.	●	○
KX XPS DRIVER	This printer driver supports the XPS (XML Paper Specification) format developed by Microsoft Corporation.	-	○
KPDL mini-driver/PCL mini-driver	This is a Microsoft MiniDriver that supports PCL and KPDL. There are some restrictions on the machine features and option features that can be used with this driver.	-	○
Kyocera TWAIN Driver	This driver enables scanning on the machine using a TWAIN-compliant software application.	●	○
Kyocera WIA Driver	WIA (Windows Imaging Acquisition) is a function of Windows that enables reciprocal communication between an imaging device such as a scanner and an image processing software application. An image can be acquired using a WIA-compliant software application, which is convenient when a TWAIN-compliant software application is not installed in the computer.	-	○
FAX Driver	This makes it possible to send a document created in a computer software application as a fax via the machine.	-	○
Status Monitor	The Status Monitor shows a print system status message at the bottom right of the printing screen. You can also start Command Center RX to check and change printer settings.	●	○
File Management Utility	This makes it possible to send and save a scanned document to a specified network folder.	-	○
KYOCERA Net Direct Print	This makes it possible to print a PDF file without starting Adobe Acrobat/Reader.	-	○
KYOCERA Net Viewer	This is a utility for administrators that enables monitoring of the machine on the network.	-	○
FONTS	These are display fonts that enable the machine's built-in fonts to be used in a software application.	●	○

 **NOTE**

Installation on Windows must be done by a user logged on with administrator privileges.

When connected by USB cable, Plug and Play is disabled on this device when in Sleep mode. To continue the installation, press the **Energy Saver** key to wake the device from Low Power Mode or Sleep before continuing.

FAX functions available only on products with the fax function installed.

WIA driver and KX XPS DRIVER cannot be installed on Windows XP.

Installing Printer Driver in Windows

Express Install

The following procedure is an example for installing the software in Windows 7 using **Express Install**.

For details, refer to Custom Installation in the *Custom Install on page 2-18*.

1 Insert the DVD.

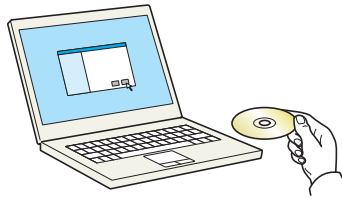

 **NOTE**

Installation on Windows must be done by a user logged on with administrator privileges.

If the **Welcome to the Found New Hardware Wizard** dialog box displays, select **Cancel**.

If the autorun screen is displayed, click **Run setup.exe**.

If the user account management window appears, click **Yes (Allow)**.

2 Display the screen.

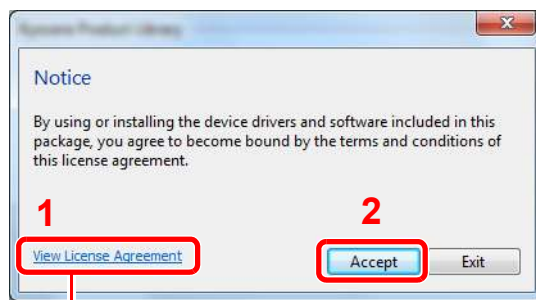

Click **View License Agreement** and read the License Agreement.

3 Install using Express Install.

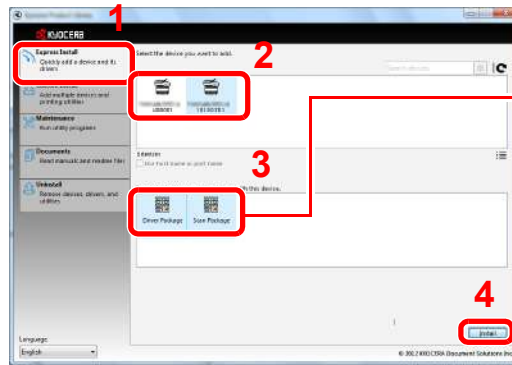

Packages include the following software:

- Driver Package
KX DRIVER, Fonts, Status Monitor
- Scan Package
Kyocera TWAIN Driver

You can also select **Use host name for port name** and set to use the host name of the standard TCP/IP port. (A USB connection cannot be used.)



NOTE

To install Status Monitor, it is necessary to install Microsoft .NET Framework 4.0 beforehand.

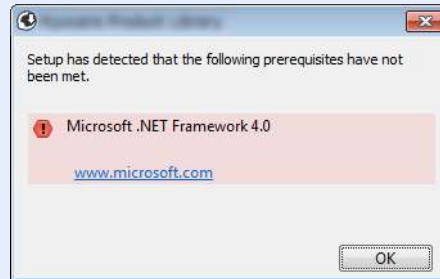

The machine cannot be detected unless it is on. If the computer fails to detect the machine, verify that it is connected to the computer via a network or USB cable and that it is turned on and click **Reload**.

If the Windows security window appears, click **Install this driver software anyway**.

4 Finish the installation.

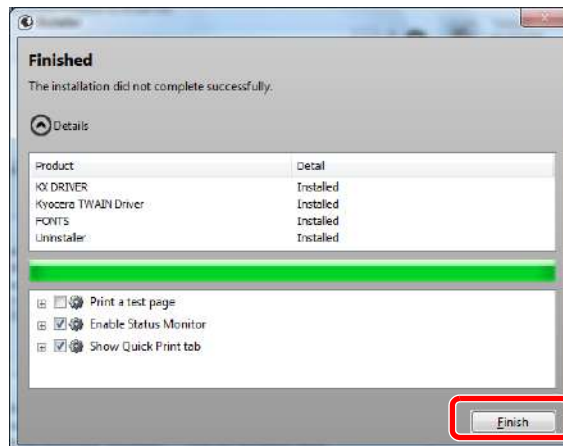

When **Your software is ready to use** appears, you can use the software. To print a test page, click the **Print a test page** checkbox and select the machine.

Click **Finish** to exit the wizard.



NOTE

When you have selected **Device settings** in Windows XP, the dialog box for device setting will appear after **Finish** is clicked. Configure the settings for options installed on the machine. Device settings can be configured after the installation is completed. For details, refer to the Device Settings in the *Printer Driver User Guide* on the DVD.

If a system restart message appears, restart the computer by following the screen prompts. This completes the printer driver installation procedure.

The TWAIN driver can be installed if the machine and computer are connected via a network.

If you are installing the TWAIN driver, continue by configuring the *Setting TWAIN Driver on page 2-24*.

Custom Install

The following procedure is an example for installing the software in Windows 7 using **Custom Install**.

1 Insert the DVD.

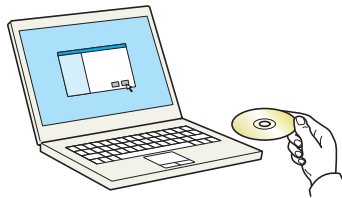

NOTE

Installation on Windows must be done by a user logged on with administrator privileges.

If the **Welcome to the Found New Hardware Wizard** dialog box displays, select **Cancel**.

If the autorun screen is displayed, click **Run setup.exe**.

If the user account management window appears, click **Yes (Allow)**.

2 Display the screen.

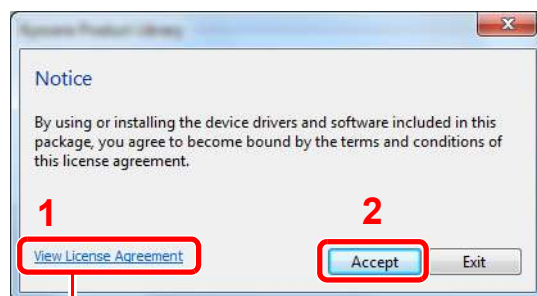

Click **View License Agreement** and read the License Agreement.

3 Install using Custom Install.

1 Select the device to be installed.

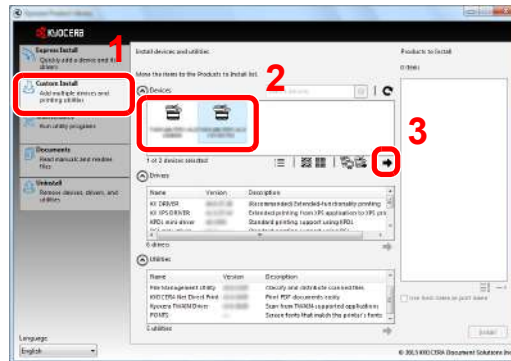

The following buttons can be used.

: This changes the display to icon and text display.

: Use this to select multiple items.

: If the desired device does not appear, press this button to directly select the device.

2 Select the driver to be installed.

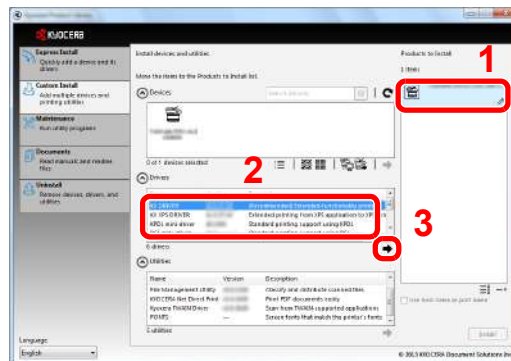

3 Select the utility to be installed.

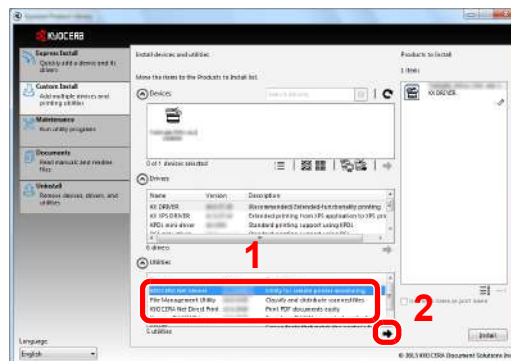

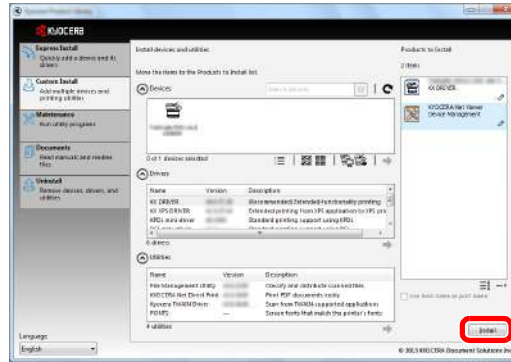
4 Click Install.**NOTE**

To install Status Monitor, it is necessary to install Microsoft .NET Framework 4.0 beforehand.

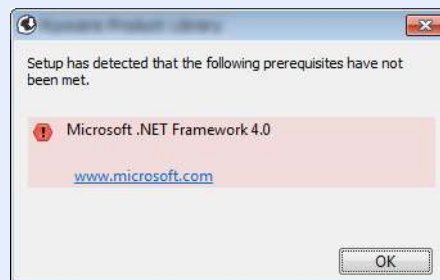
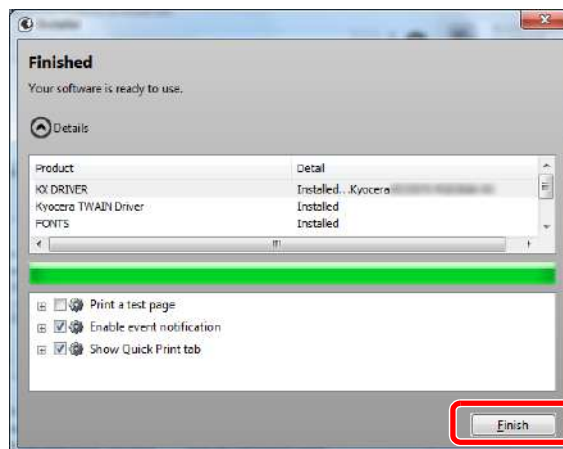
**4 Finish the installation.**

When **Your software is ready to use** appears, you can use the software. To print a test page, click the **Print a test page** checkbox and select the machine.

Click **Finish** to exit the wizard.

**NOTE**

When you have selected **Device settings** in Windows XP, the dialog box for device setting will appear after **Finish** is clicked. Configure the settings for options installed on the machine. Device settings can be configured after the installation is completed. For details, refer to the Device Settings in the *Printer Driver User Guide* on the DVD.

If a system restart message appears, restart the computer by following the screen prompts. This completes the printer driver installation procedure.

The TWAIN driver can be installed if the machine and computer are connected via a network.

If you are installing the TWAIN driver, continue by configuring the *Setting TWAIN Driver on page 2-24*.

Uninstalling the Software

Perform the following procedure to delete the Software from your computer.

NOTE

Uninstallation on Windows must be done by a user logged on with administrator privileges.

1 Display the screen.

Click **Start** button on the Windows and then select **All Programs, Kyocera,** and **Uninstall Kyocera Product Library** to display the Uninstall Wizard.

2 Uninstall the software.

Place a check in the check box of the software to be deleted.

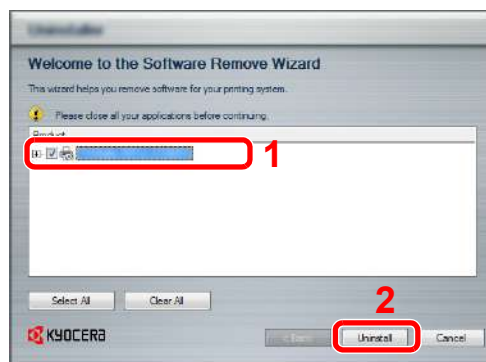

3 Finish uninstalling.

If a system restart message appears, restart the computer by following the screen prompts. This completes the software uninstallation procedure.

NOTE

The software can also be uninstalled using the Product Library.

In the Product Library installation screen, click **Uninstall**, and follow the on-screen instructions to uninstall the software.

Installing Printer Driver in Macintosh

The machine's printer functionality can be used by a Macintosh computer.

NOTE

Installation on MAC OS must be done by a user logged on with administrator privileges.

When printing from a Macintosh computer, set the machine's emulation to [KPD] or [KPD(Auto)].

 For details, refer to *Printer on page 9-17*.

If connecting by Bonjour, enable Bonjour in the machine's network settings.

 For details, refer to *Bonjour on page 9-20*.

In the Authenticate screen, enter the name and password used to log in to the operating system.

1 Insert the DVD.

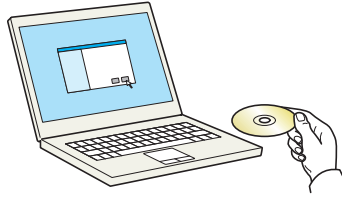

Double-click the **Kyocera** icon.

2 Display the screen.

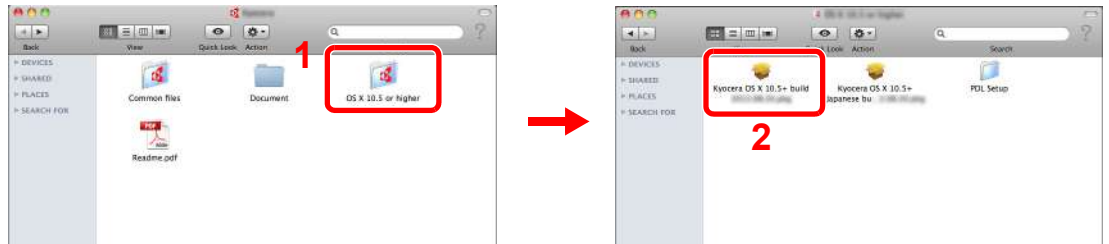

Double-click **Kyocera OS X vx.x** depending on your Mac OS version.

3 Install the Printer Driver.

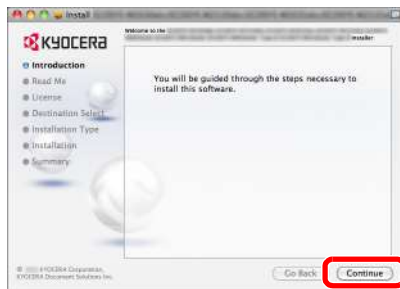

Install the printer driver as directed by the instructions in the installation software.

This completes the printer driver installation.

If a USB connection is used, the machine is automatically recognized and connected.
If an IP connection is used, the settings below are required.

4 Configure the printer.

1 Display the window.



- 2 Click the IP icon for an IP connection and then enter the IP address and printer name.

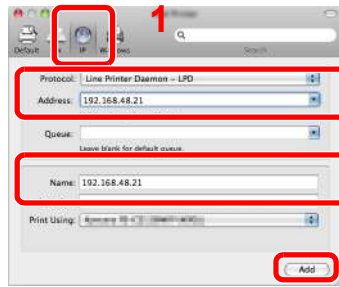

The number entered in "Address" will automatically appear in "Name". Change if needed.



NOTE

When using a Bonjour connection, select **Default** and click the item that appears in "Printer Name". The driver with the same name as the machine automatically appears in "Driver".

- 3 Select the options available for the machine and click Continue.

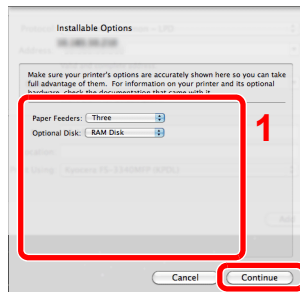

- 4 The selected machine is added.



Setting TWAIN Driver

Register this machine to the TWAIN Driver.

1 Display the screen.

- 1 Select **Start** button of the Windows display, **All Programs**, **Kyocera** and then **TWAIN Driver Setting**.
In Windows 8, select **Search** in charms, **Apps**, and then **TWAIN Driver Setting**.

2 Click Add.

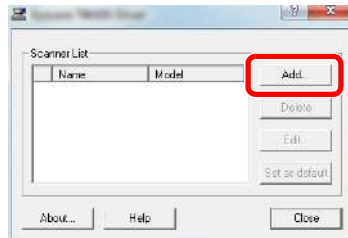

2 Configure TWAIN Driver. Network

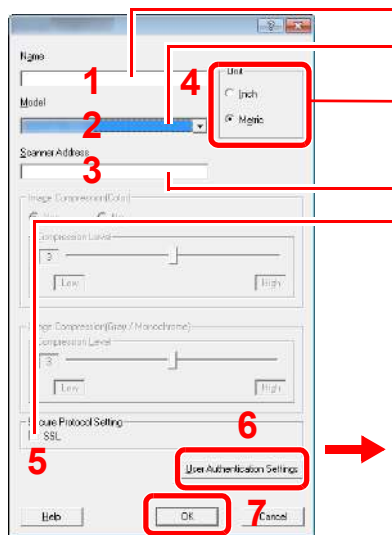

Enter the machine name.

Select this machine from the list.

Set units of measurement.

Enter the machine's IP address or host name.

When using SSL, select the checkbox beside **SSL**.

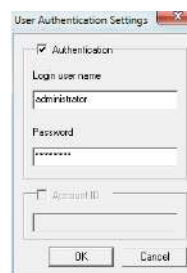

When user login administration is enabled

Select the checkbox beside **Authentication**, and enter Login User Name (up to 64 characters) and Password (up to 64 characters).

When job accounting is enabled, select the checkbox beside **Account ID**, and enter the account ID as many as eight digits.

USB

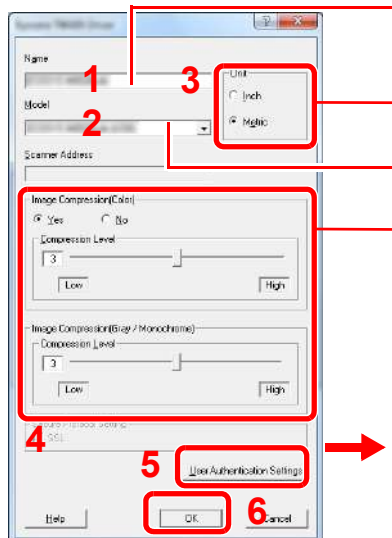

Enter the machine name.

Set units of measurement.

Select this machine from the list.

Set Image Compression and the Compression Level.



When user login administration is enabled

Select the checkbox beside **Authentication**, and enter Login User Name (up to 64 characters) and Password (up to 64 characters).

When job accounting is enabled, select the checkbox beside **Account ID**, and enter the account ID as many as eight digits.



NOTE

When the machine's IP address is unknown, contact Administrator.

3 Finish registering.

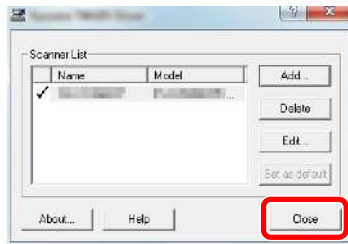

NOTE

Click **Delete** to delete the added machine. Click **Edit** to change names.

Setting WIA Driver

Register this machine to the WIA Driver. Instructions are based on interface elements as they appear in Windows 7.

NOTE
The following is not necessary to register when the machine possesses an IP address or host name that you have specified during installation of WIA Driver.

1 Display the screen.

- 1 Click the Windows **Start** button and enter **Scanner** in **Program and File Search**. Click **View scanners and cameras** in the search list.
In Windows 8, click **Search** in charms, and then **Settings**, and enter "Scanner" in the search box.
Click **View scanners and cameras** in the search list then the Scanners and Cameras screen appears.

- 2 Select the same name as this machine from WIA Drivers, and press the **Properties**.

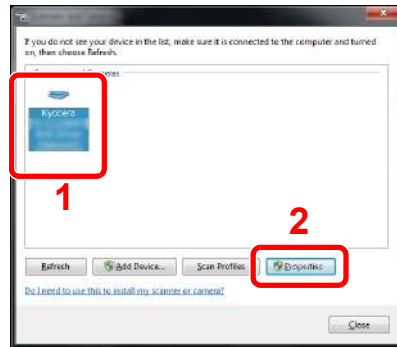

2 Configure WIA Driver.

Network

Enter the machine name.

When using SSL, select the checkbox beside **SSL**.

Set units of measurement.

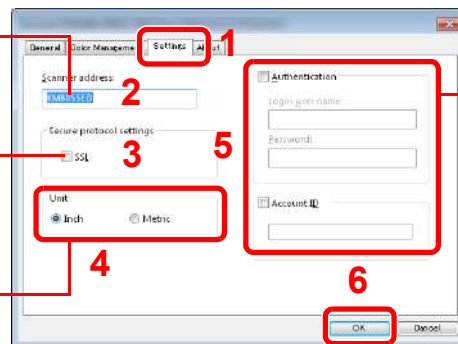

When user login administration is enabled, select the checkbox beside **Authentication**, and enter Login User Name (up to 64 characters) and Password (up to 64 characters).

When job accounting is enabled, select the checkbox beside **Account ID**, and enter the account ID as many as eight digits.

USB

Set Image Compression and the Compression Level.

Set units of measurement.

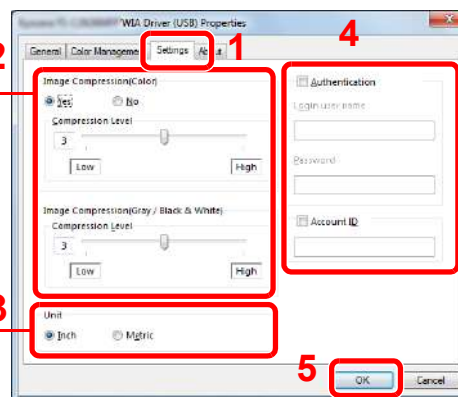

NOTE
Enter the scanner address when the device and computer are connected via a network.

Energy Saver function

If a certain period of time elapses after the machine is last used, the machine automatically enters Low Power Mode to reduce power consumption. If a further period of time elapses without the machine being used, the machine automatically enters sleep mode, which minimizes power consumption.

Low Power Mode

Energy Saver 



If the machine is not operated for a certain period of time, the Energy Saver indicator will light up and the touch panel will become dark to reduce power consumption. This status is referred to as Low Power Mode. "Low power." will be displayed on the touch panel.

The default preset time is 1 minute.



For more information about configuring settings, refer to *Low Power Timer* on page 9-27.

If print data is received during Low Power Mode, the machine automatically wakes up and starts printing. Also when fax data arrives while the machine is in Low Power Mode when using the optional fax, the machine automatically wakes up and starts printing.

To resume, perform one of the following actions.

- Press any key on the operation panel.
- Open the document processor.
- Place originals in the document processor.

The machine will be ready to operate within 11 seconds.

Note that ambient environmental conditions, such as ventilation, may cause the machine to respond more slowly.



NOTE

When a preset time of Low Power Timer and Sleep Timer is same, Sleep Mode overrides Low Power Mode.

Sleep and Auto Sleep

Energy Saver



To enter Sleep, press the **Energy Saver** key. Touch panel and all indicators on the operation panel will go out to save a maximum amount of power except the **Energy Saver** key, and Main Power indicators. This status is referred to as Sleep.

If print data is received during Sleep, the touch panel lights up and printing starts.

If you are using the products equipped with the fax function, received data is printed out while the operation panel remains unlit.

To resume, press the **Energy Saver** key. The machine will be ready to use within 20 seconds.

Note that ambient environmental conditions, such as ventilation, may cause the machine to respond more slowly.



NOTE

When a preset time of Low Power Timer and Sleep Timer is same, Sleep Mode overrides Low Power Mode.

Auto Sleep

Auto Sleep automatically switches the machine into Sleep if left idle for a preset time. The default preset time is 15 minutes.



For more information about configuring settings, refer to *Sleep Timer on page 9-27*.

Sleep Rules (models for Europe)

You can set whether sleep mode operates for each function. In addition, it takes longer for the machine to wake and return to normal operation.



For more information on Sleep Rules settings, refer to *Sleep Rules (models for Europe) on page 9-27*.

Sleep Level (Energy Saver) (models except for Europe)

This mode reduces power consumption even more than normal Sleep mode, and allows Sleep Mode to be set separately for each function. The time required for the machine to wake up from power save mode and resume normal operation will be longer than for normal Sleep Mode.



NOTE

If the optional network interface kit is installed, Energy Saver cannot be specified.



For more information on Sleep Level (Energy Saver) Mode settings, refer to *Quick Setup Wizard on page 3-29*.

Machine Setup Wizard

The Machine Setup Wizard is launched when the equipment is turned on for the first time after being installed.



Following the instructions on the screen to configure the following settings:

Date/Time settings	Time Zone
	Summer Time
	Date
	Time
Network settings	Obtain IP Address
	IP Address
	Subnet Mask
	Default Gateway



For details about settings, refer to the help information displayed on the touch panel. To make changes after this initial configuration, refer to *Date/Timer/Energy Saver* on page 9-27 and *System/Network* on page 9-19.

Command Center RX

If the machine is connected to the network, you can configure various settings using Command Center RX. This section explains how to access Command Center RX, and how to change security settings and the host name. For details on Command Center RX, refer to the *Command Center RX User Guide*.

NOTE

To fully access the features of the Command Center RX pages, enter the User Name and Password and click [[Login](#)]. Entering the predefined administrator password allows the user to access all pages, including Document Box, Address Book, and Settings on the navigation menu. The factory default setting for the default user with administrator privileges is shown below.

Login User Name	Admin
Login Password	Admin

* Upper case and lower case letters are distinguished (case sensitive).

Settings that the administrator and general users can configure in Command Center RX are as follows.

Setting	Description	Administ-rator	General User
Device Information	The machine's structure can be checked. Configuration, Counter, About Command Center RX	<input type="radio"/>	<input type="radio"/>
Job Status	Displays all device information, including print and scan jobs, storing jobs, scheduled jobs, and job log history. Printing Jobs Status, Printing Job Log, Sending Job Status, Scheduled Jobs, Sending Job Log, Storing Job Status, Storing Job Log	<input type="radio"/>	<input type="radio"/>
Document Box	Add or delete document boxes, or delete documents within a document box. Custom Box*¹, Sub Address Box*², Polling Box*², Job Box Settings	<input type="radio"/>	<input type="radio"/> * ³
Address Book	Create, edit, or delete addresses and address groups. Machine Address Book, External Address Book Settings, One Touch Key	<input type="radio"/>	<input type="radio"/> * ³
Device Settings	Configure the advanced settings of the machine. Paper/Feed/Output, Original Settings, Energy Saver/Timer, Date/Time, System	<input type="radio"/>	-
Function Settings	Configure the advanced function settings. Common/Job Defaults, Copy, Printer, E-mail, Scan to Folder, FAX*², Send and Forward, Forward Rules*¹, Operation Panel	<input type="radio"/>	-
Network Settings	Configure the network advanced settings. General, TCP/IP, Protocol	<input type="radio"/>	-
Security Settings	Configure the security advanced settings. Device Security, Send Security, Network Security, Certificates	<input type="radio"/>	-
Management Settings	Configure the advanced management settings. Job Accounting, Authentication, ID Card*⁴, Notification/Report, History Settings, SNMP, Reset	<input type="radio"/>	-

*¹ This is displayed when the optional SSD is installed.

*² Only on products with the fax function installed.

*³ The logged in user may not be able to configure some settings, depending on the permissions of the user.

*⁴ This is displayed when the optional Card Authentication Kit is installed.

NOTE

Here, information on the FAX settings has been omitted. For more information on using the FAX, refer to the *FAX Operation Guide*.

Accessing Command Center RX

1 Display the screen.

- 1 Launch your Web browser.
- 2 In the address or location bar, enter the machine's IP address or the host name.

Examples: `https://192.168.48.21/` (for IP address)
`https://MFP001` (if the host name is "MFP001")

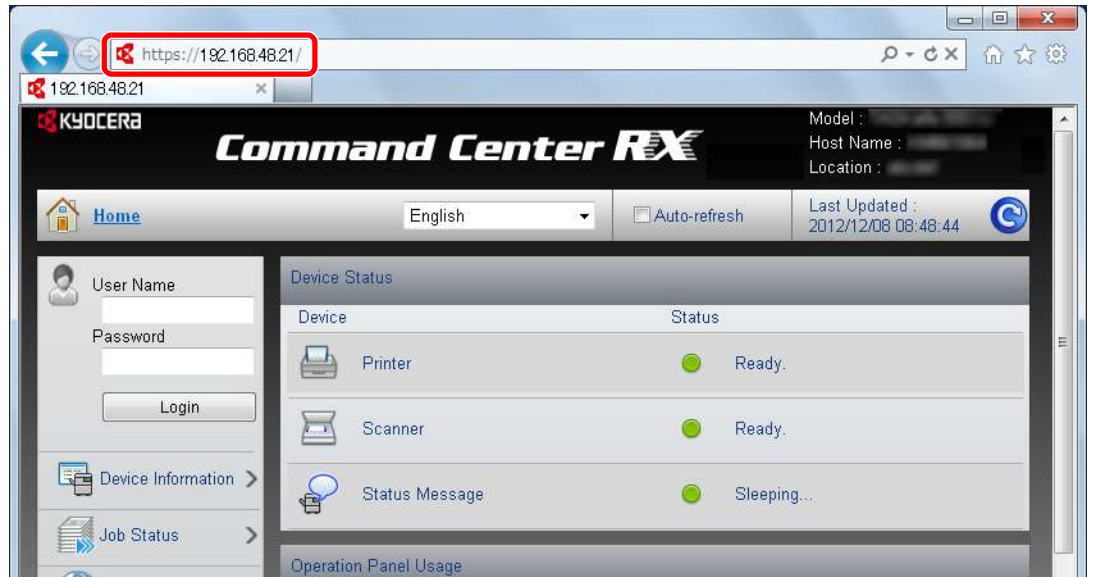

The web page displays basic information about the machine and Command Center RX as well as their current status.



NOTE

If the screen "There is a problem with this website's security certificate." is displayed, configure the certificate. For details on Certificates, refer to the *Command Center RX User Guide*.

You can also continue the operation without configuring the certificate.

2 Configure the function.

Select a category from the navigation bar on the left of the screen. When you log in to the machine as an administrator, you will see **Device Settings**, **Function Settings**, **Network Settings**, **Security Settings**, and **Management Settings**.

Changing Security Settings

This section explains how to change the security settings.

1 Display the screen.

Access Command Center RX by referring to *Accessing Command Center RX on page 2-31*.

2 Configure the Security Settings.

From the **Security Settings** menu, select the setting you want to configure. The configurable settings are **Device Security**, **Send Security**, **Network Security**, and **Certificates**.

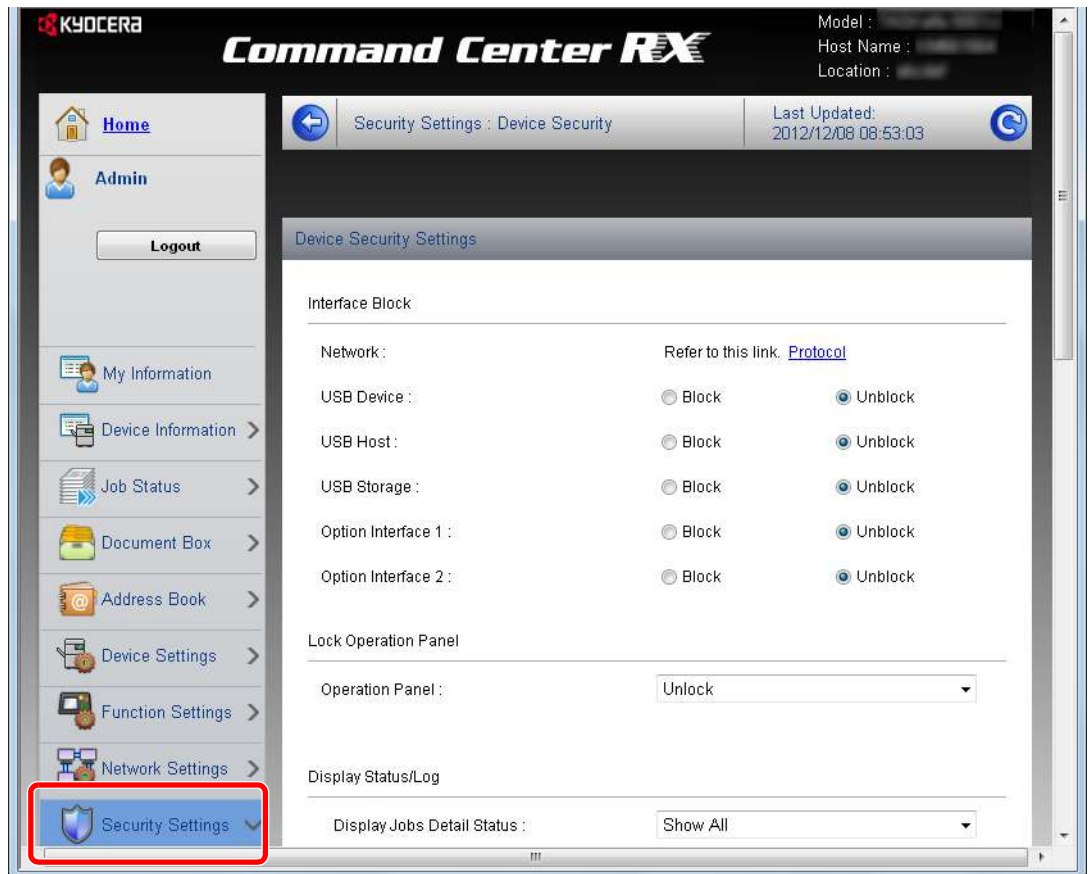

NOTE

The configurable settings within **Device Security**, **Send Security**, and **Network Security** can also be configured from the machine's System Menu.

For details, see *System Menu on page 9-2*.

For details on settings related to certificates, refer to the *Command Center RX User Guide*.

Changing Device Information

Change the device information of the machine.

1 Display the screen.

- 1 Access Command Center RX by referring to *Accessing Command Center RX on page 2-31*.
- 2 From the **Device Settings** menu, select **System**.



2 Specify the host name.

Enter the device information, and then click **Submit**.

✓ IMPORTANT

After changing the setting, restart the network or turn the machine OFF and then ON.

To restart the network interface card, click **Reset** in the **Management Settings** menu, and then click **Restart Network** in "Restart".

E-mail settings

By configuring the SMTP settings, you can send E-mail notifications on completed jobs.

To use this function, this machine must be connected to a mail server using the SMTP protocol.

In addition, check the following.

- The network environment used to connect this machine to the mail server
A full-time connection via a LAN is recommended.
- SMTP settings
Use Command Center RX to register the IP address or host name of the SMTP server.
- If limits have been set on the size of E-mail messages, it may not be possible to send very large E-mails.

The procedure for specifying the SMTP settings is explained below.

1 Display the screen.

- 1 Access Command Center RX by referring to *Accessing Command Center RX on page 2-31*.
- 2 From the **Function Settings** menu, click **E-mail**.

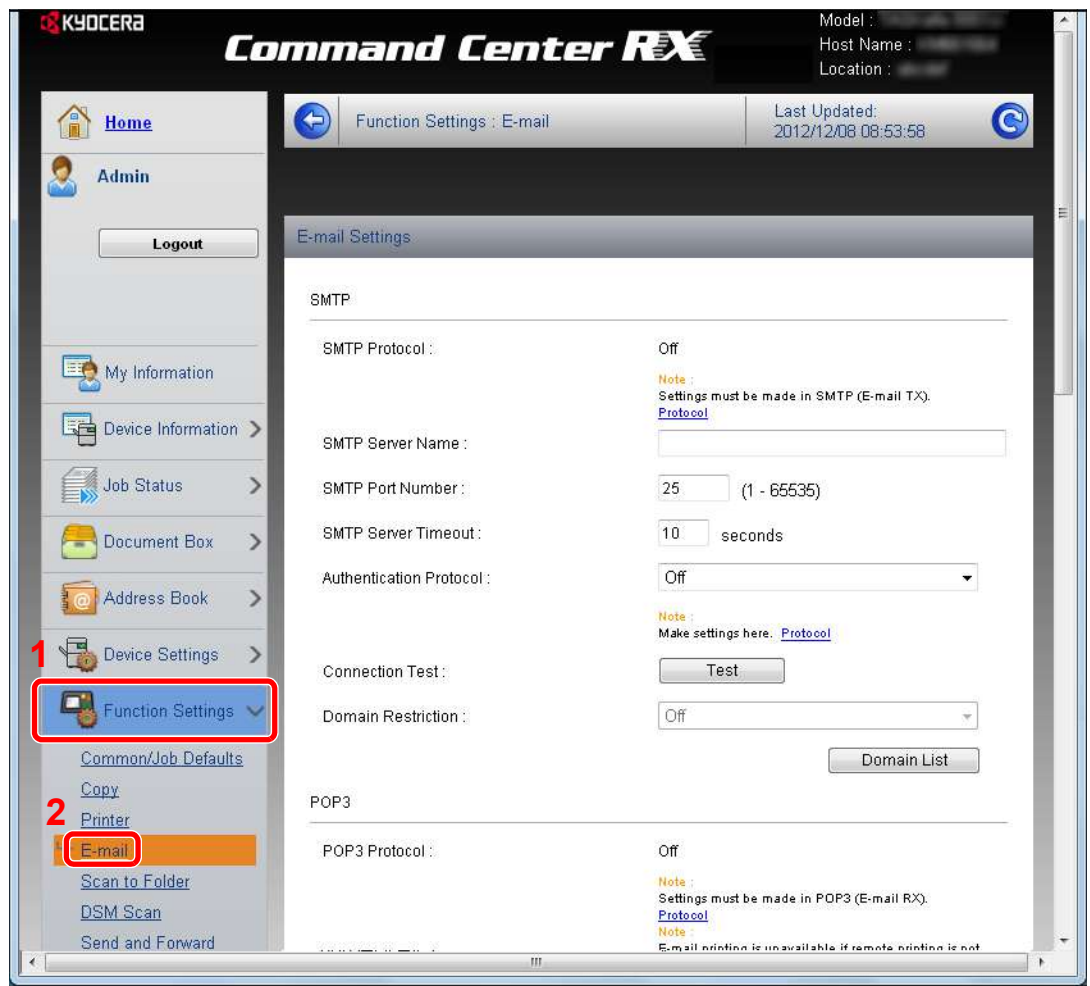

2 Configure the settings.

Enter the appropriate values to each field.

Setting	Description
SMTP	Set to send e-mail from the machine.
SMTP Protocol	Set SMTP protocol. Set the "SMTP (E-mail TX)" setting to On on the Protocol Settings page.
SMTP Server Name	Enter the host name or IP address of the SMTP server.
SMTP Port Number	Specify the port number to be used for SMTP. Use the SMTP default port 25.
SMTP Server Timeout	Set the amount of time to wait before time-out in seconds.
Authentication Protocol	Set whether SMTP authentication is used. To use authentication, enter the user information for authentication.
SMTP Security	Set SMTP security. Turn on "SMTP Security" in "SMTP (E-mail TX)" on the Protocol Settings page.
POP before SMTP Timeout	Specify the time in seconds until the connection to the POP server times out. This can be set when POP before SMTP is selected in "Authentication Protocol".
Connection Test	Tests to confirm that the settings are correct.
Domain Restriction	Set whether or not domains are restricted. Click the Domain List and enter the domain names of addresses to be allowed or rejected. Restriction can also be specified by e-mail address.
POP3	Set to receive e-mail at the machine.
POP3 Protocol	Set POP3 protocol. Set the "POP3 (E-mail RX)" setting to On on the Protocol Settings page.
Check Interval	Specify the interval for checking for incoming e-mail in minutes.
Run once now	Click Receive to connect to the POP3 server immediately and check for incoming E-mails.
Domain Restriction	Set whether or not domains are restricted. Click the Domain List and enter the domain names of addresses to be allowed or rejected. Restriction can also be specified by e-mail address.
POP3 User Settings	Configure the settings for POP3 user accounts and the POP3 server. You can configure up to three users.

Setting		Description
E-mail Send Settings	E-mail Size Limit	Enter the maximum size of E-mail that can be sent in kilobytes. When E-mail size is greater than this value, an error message appears and E-mail sending is cancelled. Use this setting if you have set E-mail Size Limit for SMTP server. If not, enter a value of 0 (zero) to enable E-mail sending regardless of the size limit.
	Sender Address	Enter the E-mail address of the person responsible for the machine, such as the machine administrator, so that a reply or non-delivery report will go to a person rather than to the machine. The sender address must be entered correctly for SMTP authentication. The maximum length of the sender address is 128 characters.
	Signature	Enter the signature. The signature is free form text that will appear at the end of the E-mail body. It is often used for further identification of the machine. The maximum length of the signature is 512 characters.
	Function Defaults	Change the function default settings in Common/Job Default Settings page.

3 Click Submit.

Registering Destinations

You can register destinations to the machine's Address Book, from Command Center RX.

1 Display the screen.

- 1 Access Command Center RX by referring to *Accessing Command Center RX on page 2-31*.
- 2 From the **Address Book** menu, click **Machine Address Book**.



- 3 Click **Add**.

2 Populate the fields.

- 1 Enter the destination information.

Enter the information for the destination you want to register. The fields to populate are the same as when registering via operation panel.

 *Registering Destinations in the Address Book on page 6-24*

- 2 Click **Submit**.

Registering a Custom Box

You can register a custom box from Command Center RX.

1 Display the screen.

- 1 Access Command Center RX by referring to *Accessing Command Center RX on page 2-31*.
- 2 From the **Document Box** menu, click **Custom Box**.



- 3 Click **Add**.

2 Configure the Custom Box.

- 1 Enter the box details.

Enter the information for the custom box you want to register. The fields to populate are the same as when registering on the machine.

 *Creating a New Custom Box (Add/Edit Box) on page 7-3*

- 2 Click **Submit**.

Printing a document stored in a Custom Box

A document stored in a Custom Box can be printed from Command Center RX.

1 Display the screen.

- 1 Access Command Center RX by referring to *Accessing Command Center RX on page 2-31*.
- 2 From the **Document Box** menu, click **Custom Box**.



- 3 Click the number or name of the Custom Box in which the document is stored.

2 Print the document.

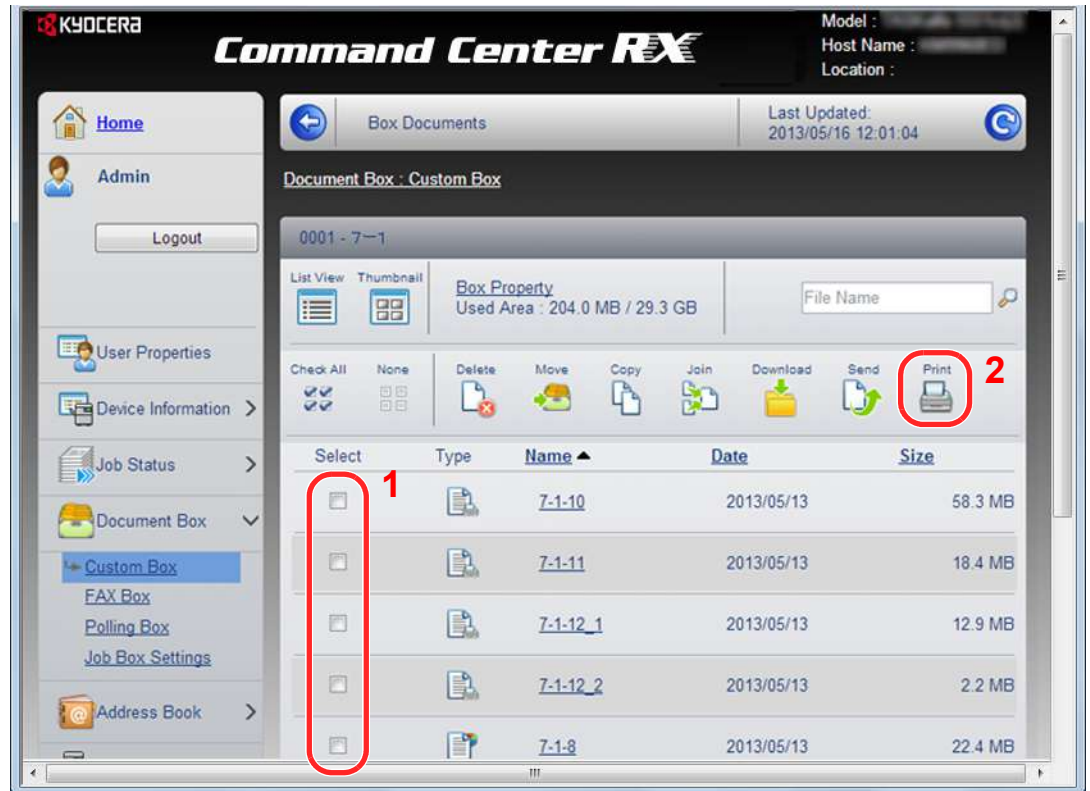

- 1 Select the document you wish to print.

Select the checkbox of the document to be printed.

- 2 Click **Print**.

For settings that are configurable, refer to *Command Center RX User Guide*.

3 Common Operations

This chapter explains the following topics:

Loading Paper	3-2
Before Loading Paper	3-2
Loading Paper in the Cassettes	3-3
Loading Paper in the Multi Purpose Tray	3-6
Loading Originals	3-10
Placing Originals on the Platen	3-10
Loading Originals in the Document Processor	3-11
Checking the Equipment's Serial Number	3-13
Checking the Counter	3-14
Login/Logout	3-15
Login	3-15
Logout	3-16
Favorites	3-17
Registering Favorites	3-17
Editing and Deleting Favorites	3-21
Using Favorites	3-23
Shortcuts	3-25
Registering Shortcuts	3-25
Editing and Deleting Shortcuts	3-27
Using Shortcuts	3-28
Quick Setup Wizard	3-29
Help Screen	3-31
Canceling Jobs	3-32
Using Various Functions	3-33
Common Functionality	3-34
Original Size	3-35
Original Orientation	3-36
Duplex	3-37
Continuous Scan	3-39
Paper Selection	3-41
Collate	3-42
Density	3-43
Scan Resolution	3-44
Original Image	3-45
EcoPrint	3-46
Sharpness	3-47
Background Density Adjust	3-48
Zoom	3-49
File Format	3-50
Color Selection	3-53
Job Finish Notice	3-54
File Name Entry	3-56
Priority Override	3-57

Loading Paper

Paper can be loaded standardly in the cassette and the multi purpose tray. A paper feeder is also available as an option (refer to *Optional Equipment* on page 11-2).

Before Loading Paper

When you open a new package of paper, fan the sheets to separate them slightly prior to loading in the following steps.

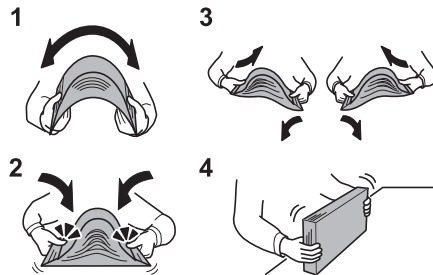

- 1 Bend the whole set of sheets to swell them in the middle.
- 2 Hold the stack at both ends and stretch it while keeping the entire stack swelled.
- 3 Raise the right and left hands alternately to create a gap and feed air between the papers.
- 4 Finally, align the papers on a level, flat table.

If the paper is curled or folded, straighten it before loading. Paper that is curled or folded may cause a jam.

 **IMPORTANT**

If you copy onto used paper (paper already used for copying), do not use paper that is stapled or clipped together. This may damage the machine or cause poor image quality.

 **NOTE**

If printouts are curled, turn the stack in the cassette upside down.

If you use special paper such as letterhead, paper with holes or paper with pre-prints like logo or company name, refer to *Paper* on page 11-11.

Avoid exposing opened paper to high temperatures and high humidity as dampness can be a cause of problems. Seal any remaining paper after loading in the multi purpose tray or cassettes back in the paper storage bag.

If the machine will not be used for a prolonged period, protect all paper from humidity by removing it from the cassettes and sealing it in the paper storage bag.

Loading Paper in the Cassettes

The standard cassette will each hold plain paper, recycled paper or color paper. The standard cassette holds up to 250 sheets of plain paper (80 g/m²).

The following paper sizes are supported: A4, A5, A6, B5, Legal, Letter, Other (Folio, Oficio II, Executive, Statement, 16K, Envelope C5 and 216 × 340mm)

NOTE

You should not use inkjet printer paper or any paper with a special surface coating. (Such paper may cause paper jams or other faults.)

For clearer and brighter color copies, use the special color paper.

When using media types other than plain paper (such as recycled or colored paper), always specify the media type setting. (Refer to *Media Type* on page 9-7) The cassettes can hold paper with weights up to 163 g/m².

If the machine will not be used for a prolonged period, protect all paper from humidity by removing it from the cassettes and sealing it in the paper storage bag.

1 Adjust the cassette size.

1

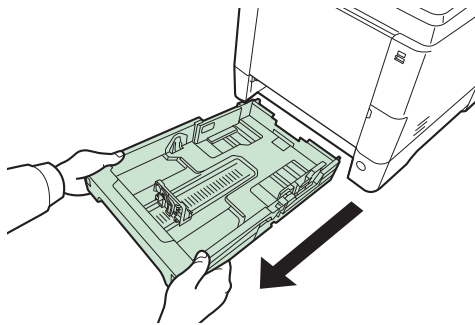

IMPORTANT

When pulling the cassette out of the machine, ensure it is supported and does not fall out.

2

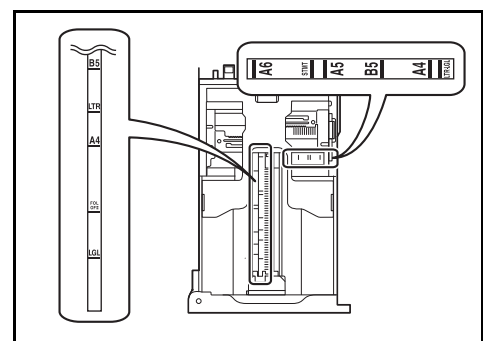
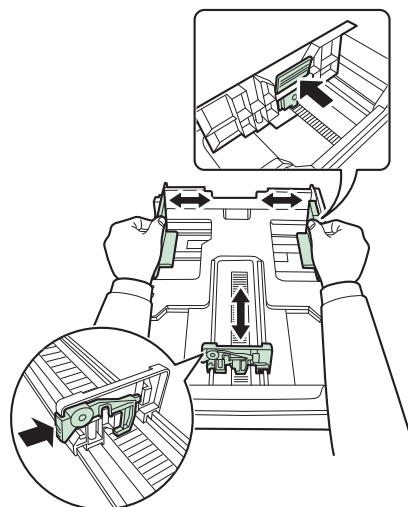

Adjust the cassette size to reflect the size of paper being loaded. Paper sizes are marked on the cassette.

2 Turn the paper size dial to the size of the paper.

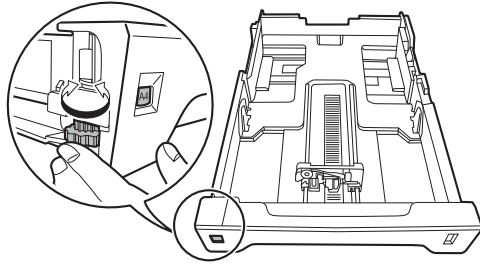

✔ IMPORTANT

To use a paper size that does not appear on the size dial, set the size dial to "Other". The paper size must also be set from the operation panel. For details, see *Quick Setup Wizard* on page 3-29.

3 Load paper.

1

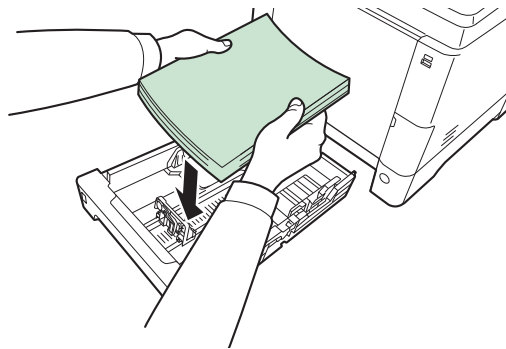

✔ IMPORTANT

Load the paper with the print side facing up.

Before loading the paper, be sure that it is not curled or folded. Paper that is curled or folded may cause paper jams.

Ensure that the loaded paper does not exceed the level indicator (see the figure).

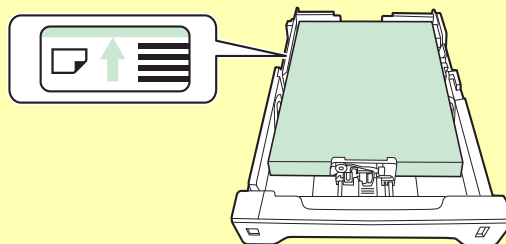

When loading the paper, keep the side that was closest the package seal facing up.

The paper length and width guides must be adjusted to the paper size. Loading the paper without adjusting these guides may cause skewed feeding and paper jams.

Be sure that the paper length and width guides rest securely against the paper. If there is a gap, readjust the guides to fit the paper.

2

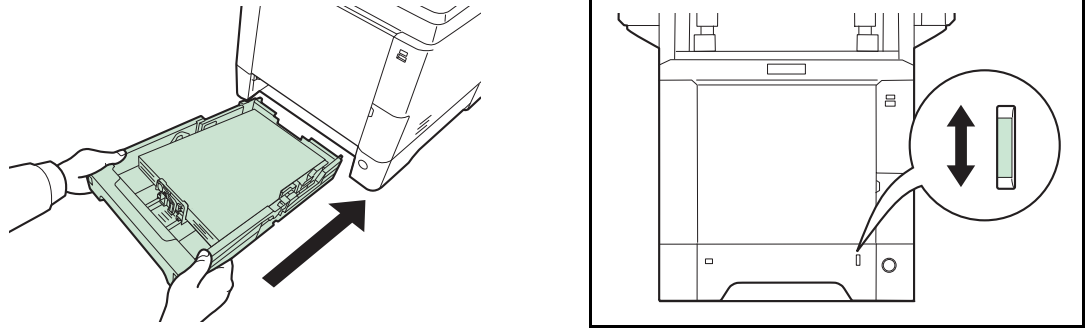

There is a paper gauge on the right side of the front of the cassette to indicate the remaining paper supply. When paper is exhausted, the pointer will go down to the level of (empty).

✔ **IMPORTANT**

When pulling out the cassette from the machine, confirm there is no paper left in the machine. Be sure that the paper is properly set in the cassette.

💡 **NOTE**

To use the paper stopper, open as shown below. (Example: Legal)

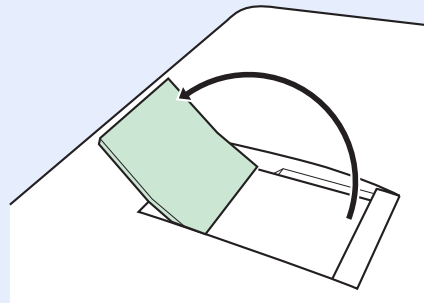

If the machine will not be used for a prolonged period, protect all paper from humidity by removing it from the cassettes and sealing it in the paper storage bag.

Loading Paper in the Multi Purpose Tray

The multi purpose tray will hold up to 50 sheets of Legal or smaller plain paper (80 g/m²).

The multi purpose tray accepts paper sizes from A4 to A6 and Hagaki and from Legal to Statement, and 16K. Be sure to use the multi purpose tray when you print on any special paper.

✔ IMPORTANT

When using media types other than plain paper (such as recycled or colored paper), always specify the media type setting. (Refer to *Quick Setup Wizard* on page 3-29.) If you are using a paper weight of 106 g/m² or more, set the media type to *Thick*.

The capacity of the multi purpose tray is as follows.

- A4 or smaller plain paper (80 g/m²), recycled paper or color paper: 50 sheets
- Hagaki: 15 sheet
- OHP film: 1 sheet
- Envelope DL, Envelope C5, Envelope #10 (Commercial #10), Envelope #9 (Commercial #9), Envelope #6 (Commercial #6 3/4), Monarch, Youkei 4, Youkei 2: 5 sheets
- Heavy paper (128 to 220 g/m²): 30 sheets

🔍 NOTE

When you load custom size paper, enter the paper size by referring to *Paper Size* on page 9-8.

When you use special paper such as thick paper, select the media type by referring to *Media Type* on page 9-8.

1 Adjust the multi purpose tray size.

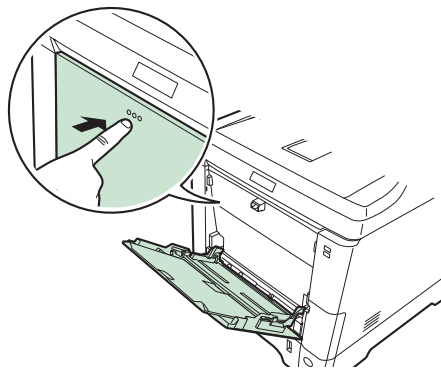

2

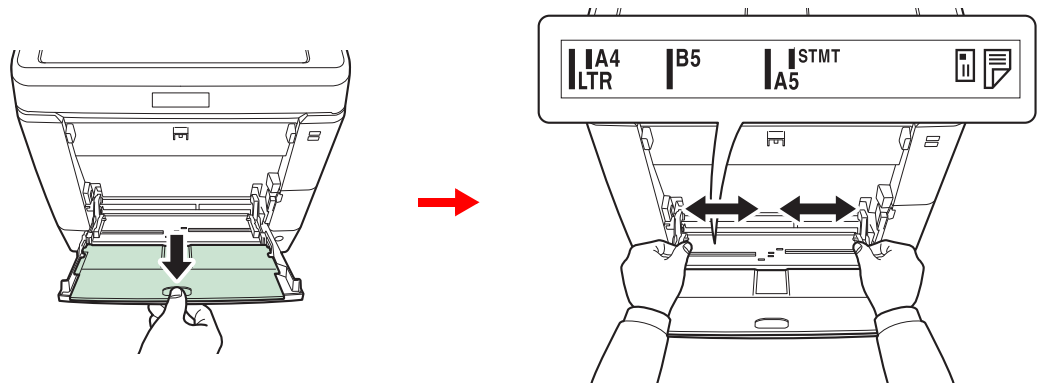

When using legal size paper, pull out the sub tray.

2 Load paper.

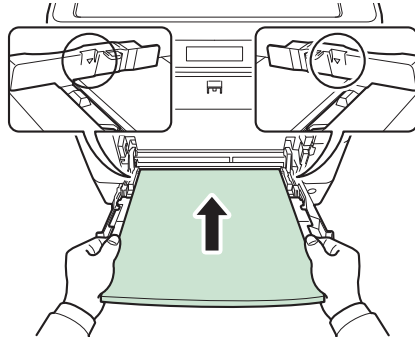

Insert the paper along the paper width guides into the tray until it stops.

✔ IMPORTANT

Keep the side that was closest the package seal facing up.

Curled paper must be uncurled before use.

Straighten the top edge if it is curled.

When loading paper into the multi purpose tray, check that there is no paper left over in the tray from a previous job before loading the paper. If there is just a small amount of paper left over in the multi purpose tray and you want to add more, first remove the left-over paper from the tray and include it with the new paper before loading the paper back into the tray.

○		
×		

3 Specifying Paper Size and Media Type for the Multi Purpose Tray.



Refer to *Quick Setup Wizard* on page 3-29.

Loading Envelopes

5 envelope may be loaded in the multi purpose tray.
Acceptable envelope sizes are as follows.

Acceptable Envelope	Size
Hagaki	148 × 100 (mm)
Oufuku Hagaki	148 × 200 (mm)
Youkei 2	162 × 114 (mm)
Youkei 4	235 × 105 (mm)
Monarch	3-7/8" × 7-1/2"
Envelope #10 (Commercial #10)	4-1/8" × 9-1/2"
Envelope DL	110 × 220 (mm)
Envelope C5	162 × 229 (mm)
Executive	7-1/4" × 10-1/2"
Envelope #9 (Commercial #9)	3-7/8" × 8-7/8"
Envelope #6 (Commercial #6-3/4)	3-5/8" × 6-1/2"
ISO B5	176 × 250 (mm)

When you load envelopes or cardstock in the multi purpose tray

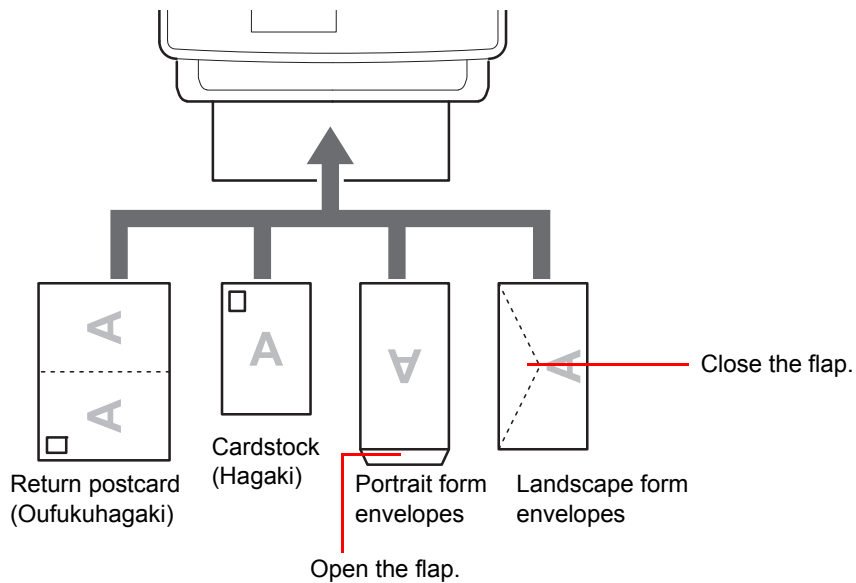

Load envelope with the print side facing up.

✔ **IMPORTANT**

How to load envelopes (orientation and facing) will differ depending on the type of envelope. Be sure to load it in correctly, otherwise printing may be done in the wrong direction or on the wrong face.

If the Cardstock is warped, press on the warped area before putting it in the multi purpose tray.

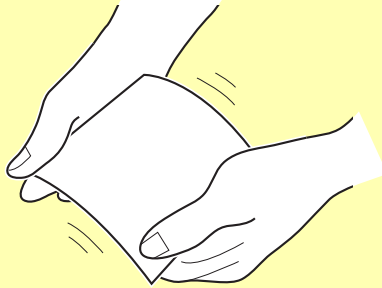

When you load envelopes in the multi purpose tray, select the envelope type by referring to *Multi Purpose Tray* on page 9-8.

Loading Originals

Placing Originals on the Platen

You may place books or magazines on the platen in addition to ordinary sheet originals.

 **NOTE**

Before opening the document processor, be sure that there are no originals left on the original table or on the original eject table. Originals left on the original table or on the original eject table may fall off when the document processor is opened.

Shadows may be produced around the edges and in the middle of open-faced originals.

Align it flush against the original size indicator plates with the back left corner as the reference point.

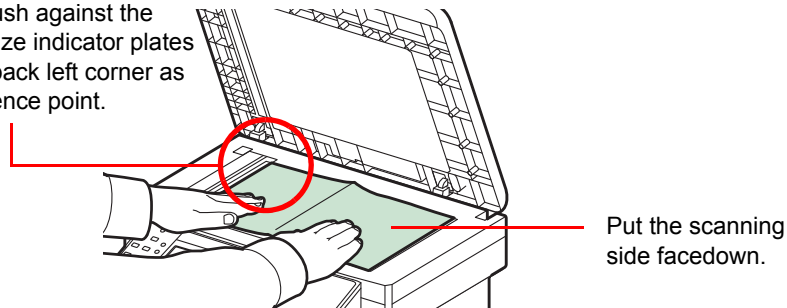

Put the scanning side facedown.

Open the document processor, and place the original.

 **CAUTION**

Do not leave the document processor open as there is a danger of personal injury.

 **IMPORTANT**

Do not push the document processor forcefully when you close it. Excessive pressure may crack the platen glass.

When placing books or magazines on the machine, do so with the document processor in the open position.

Loading Originals in the Document Processor

The document processor automatically scans each sheet of multiple originals. Both sides of two-sided originals are scanned.

Originals Supported by the Document Processor

Weight	50 to 120 g/m ² (duplex: 50 to 110 g/m ²)
Size	Maximum A4 to Minimum A5 Maximum Legal to Minimum Statement
Capacity	Plain paper (80 g/m ²), Colored paper, Recycled paper, High quality paper: 50 sheets Plain paper (105 g/m ²): 37 sheets Thick paper (120 g/m ²): 33 sheets Art paper: 1 sheet

Originals Not Supported by the Document Processor

- Soft originals such as vinyl sheets
- Transparencies such as OHP film
- Carbon paper
- Originals with very slippery surfaces
- Originals with adhesive tape or glue
- Wet originals
- Originals with correction fluid which is not dried
- Irregularly shaped (non-rectangular) originals
- Originals with cut-out sections
- Crumpled paper
- Originals with folds (Straighten the folds before loading. Failure to do so may cause the originals to jam).
- Originals bound with clips or staples (Remove the clips or staples and straighten curls, wrinkles or creases before loading. Failure to do so may cause the originals to jam).

How to Load Originals

✔ IMPORTANT
Before loading originals, be sure that there are no originals left on the original eject table. Originals left on the original eject table may cause the new originals to jam.

1 Adjust the original table size.

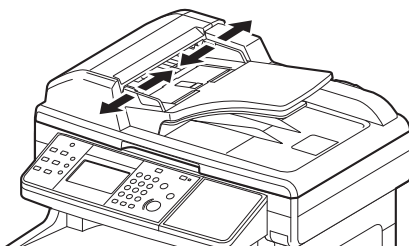

2 Load Originals.

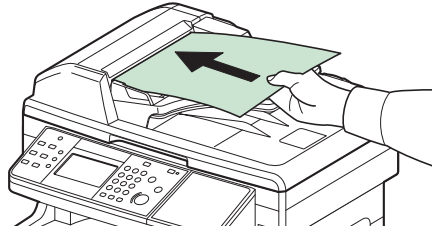

Put the side to be scanned (or the first side of two-sided originals) face-up. Slide the leading edge into the document processor as far as it will go.



NOTE

Ensure that loaded originals do not exceed the level indicator. Exceeding the maximum level may cause the originals to jam (see the figure).

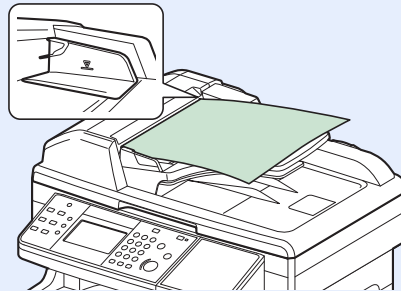



Confirm that the original width guides exactly fit the originals. If there is a gap, readjust the original width guides. The gap may cause the originals to jam.

Originals with punched holes or perforated lines should be placed in such a way that the holes or perforations will be scanned last (not first).

Checking the Equipment's Serial Number

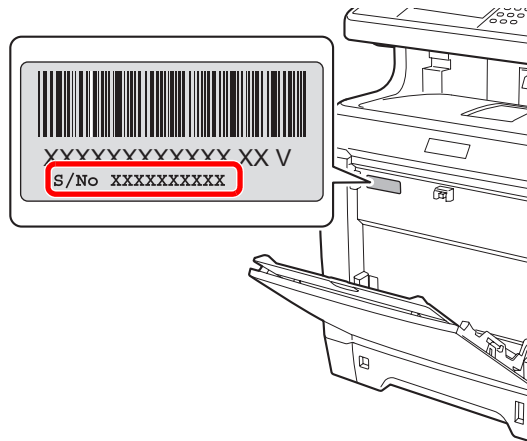
The equipment's serial number is printed in the location shown in the figure.



 **NOTE**
You'll need the equipment's serial number when contacting your Service Representative. Please check the number before contacting your Service Representative.

Checking the Counter

Check the number of pages printed and scanned.

1 Display the screen.

◆ System Menu / Counter

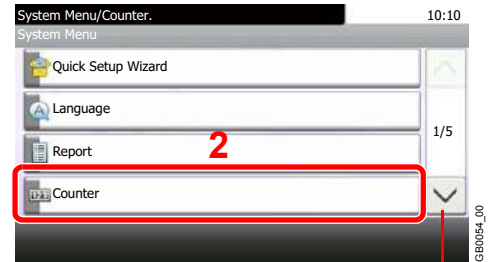
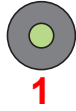

Use [∨] or [∧] to scroll up and down.

2 Check the counter.

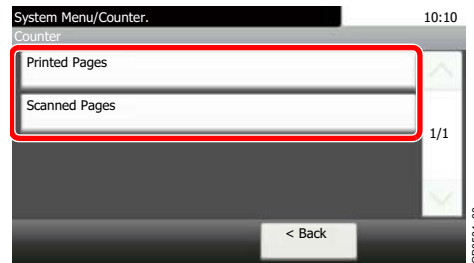

Select the job you wish to check.

[Printed Pages]

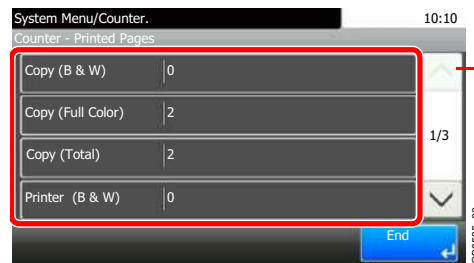

Use [∨] or [∧] to scroll up and down.

Scroll the screen to check the number of pages. Pressing [Count by Paper Size] and then [Full Color] or [Black & White] allows you to check the number of pages by paper size.

[Scanned Pages]

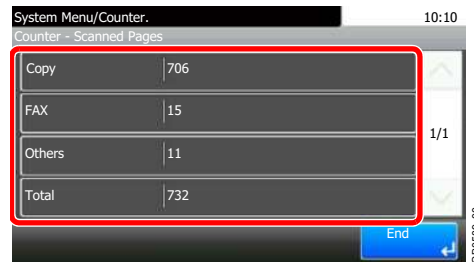

Login/Logout

If user login administration is enabled, it is necessary to enter the login user name and password to use the machine.

 Refer to *Adding a User on page 9-40* for the default login user name and password.

 **NOTE**

You will be unable to login if you forget your login user name or login password. In this event, login with administrator privileges and change your login user name or login password.

Login

Normal login

1 Enter the login user name.

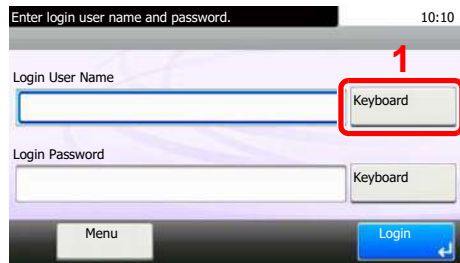

If this screen is displayed during operations, press [Keyboard] to enter the login user name. The name can also be entered using the numeric keypad.

 Refer to *Character Entry Method on page 11-8* for details on entering characters.

2 Enter the login password.

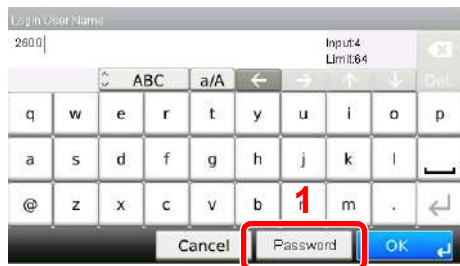

Press [Password] to enter the login password.

3 Log in.

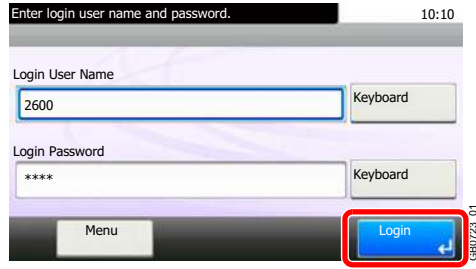

NOTE

If *Network Authentication* is selected as the user authentication method, either Local or Network can be selected as the authentication destination.

Simple Login



If this screen is displayed during operations, select a user and log in.



NOTE

If a user password is required, an input screen will be displayed.



Refer to *Simple Login* on page 9-51.

Logout

To logout from the machine, press the Logout key to return to the login user name/password entry screen.

Logout



Users are automatically logged out in the following circumstances:

- When the machine is put to Sleep by pressing the **Energy Saver** key.
- When the Auto Sleep function is activated.
- When the auto panel reset function is activated.

Favorites

Frequently used functions can be registered as favorites so that they can be called up easily.

The following functions are pre-registered on this machine. You can delete these functions as well as register new functions.

- ID Card Copy
- Paper Saving Copy
- Scan to PC (Address Entry)
- Scan to PC (Address Book)
- Scan to E-mail (Address Entry)
- Scan to E-mail (Address Book)

Registering Favorites

When registering a favorite, you can choose from two methods for calling it up:

- *Wizard* mode: Registered settings are called up in order and configured as you check or change each one.
- *Program* mode: Settings are called up immediately when you press the key to which they are registered.



NOTE

Up to 20 settings can be registered as favorites.

1 Configure the function.

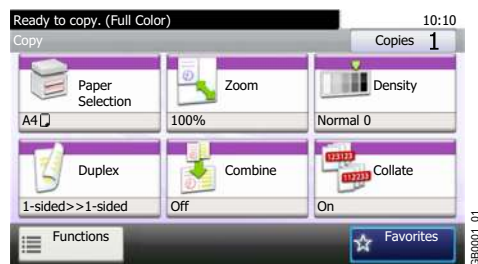

When registering favorites in program mode, configure the copy function, send function*, destination, or other setting to register.

* Only on products with the fax function installed.

2 Display the screen.

Favorites/
Application



1

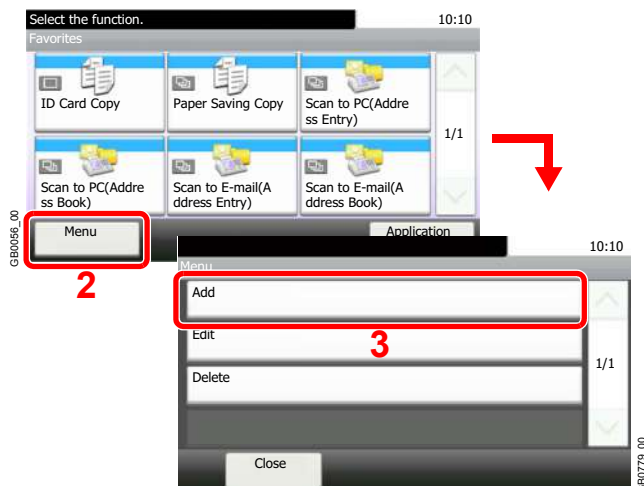



NOTE

Press [Application] to display the Application screen. You can install applications that enable your daily work to be accomplished more efficiently. For the applications, see *Favorites/ Application on page 9-16*.

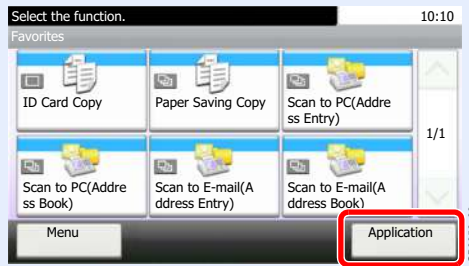

3 Select the job type.

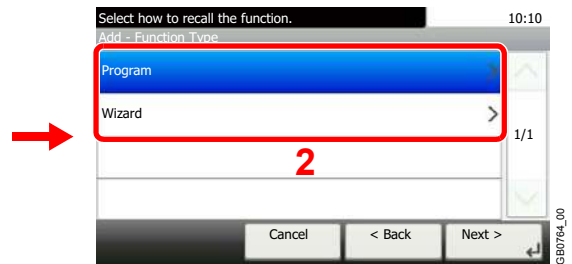
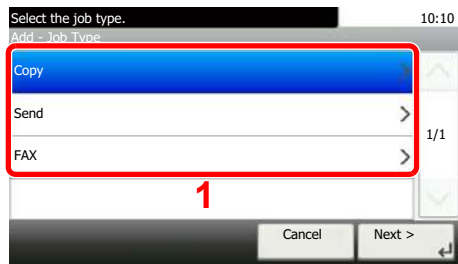

When you select the wizard mode

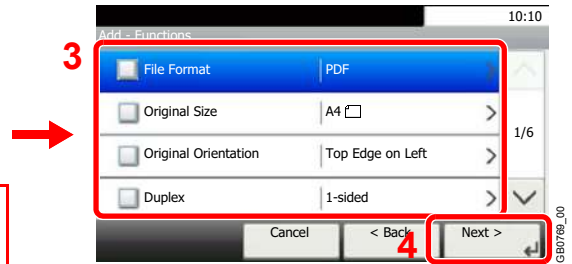
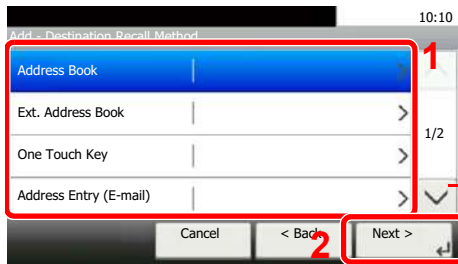

Use [∨] or [∧] to scroll up and down.

Select the function. Checked items will be shown as part of the wizard.



NOTE

When the job type is *Copy*, the Destination Recall Method screen will not be displayed.

4 Enter a name.

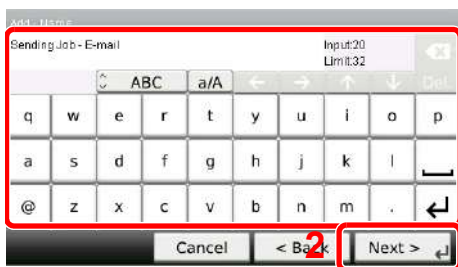

Refer to *Character Entry Method on page 11-8* for details on entering characters.

5 Check the settings.

Check the settings and change or add information as needed.

[Name]

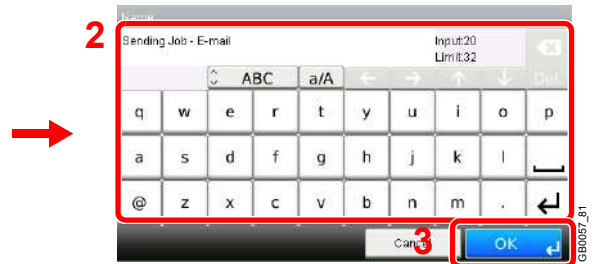
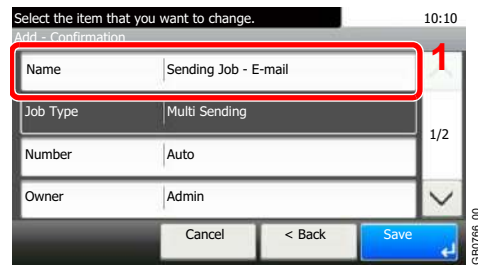

[Number]

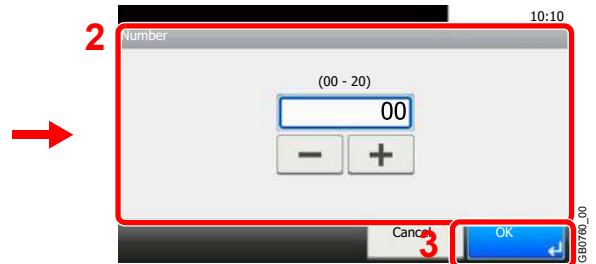
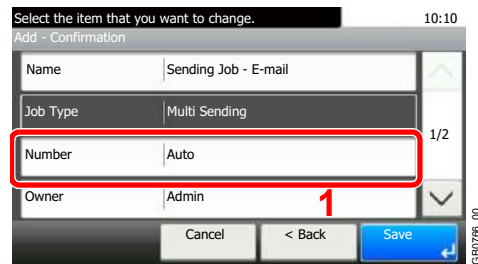

[Permission]

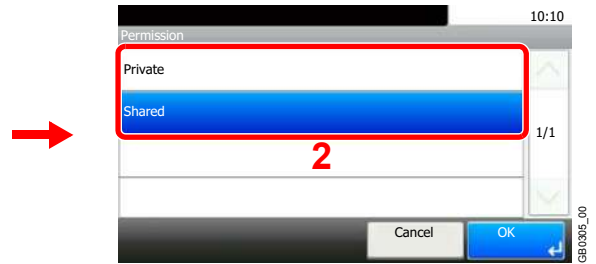
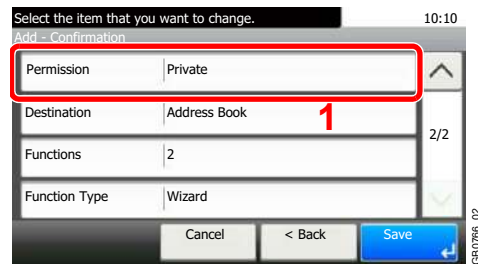

Configures permission settings for favorites to determine how they are shared with other users.

[Destination]

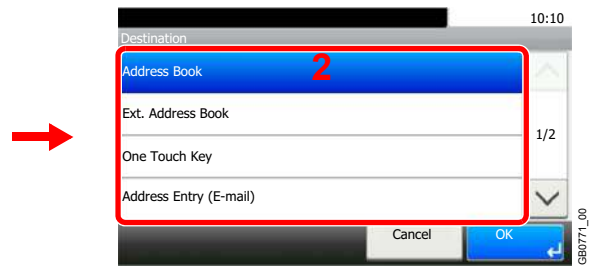
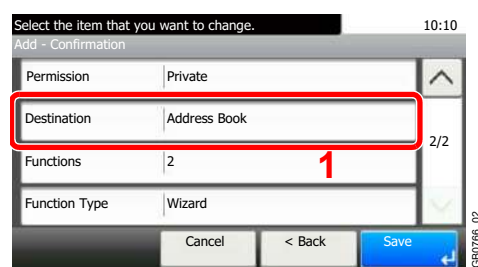

When the job type is [Send] or [FAX], selects the Destination Recall Method.

[Functions]

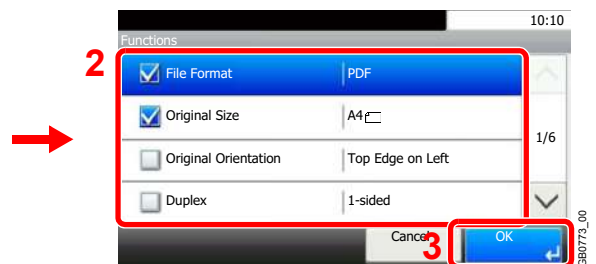
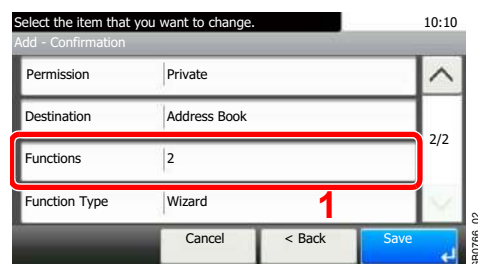

If you selected wizard mode, check the function and make changes as necessary.

[Function Type]

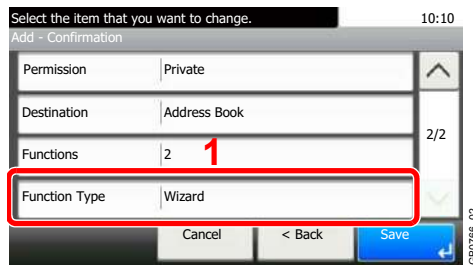

6 Register the favorite.

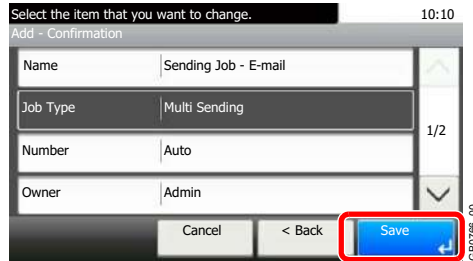

Editing and Deleting Favorites

This section describes how to edit name and permission of the registered favorites and how to delete favorites.

1 Display the screen.

Favorites/
Application



1



2

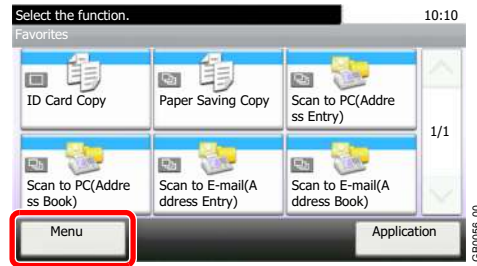

2 Edit or delete a favorite.

To edit a favorite

1 Select the favorite you wish to edit.

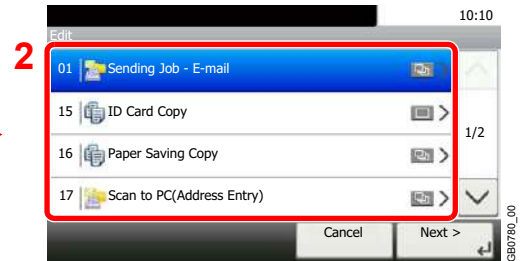
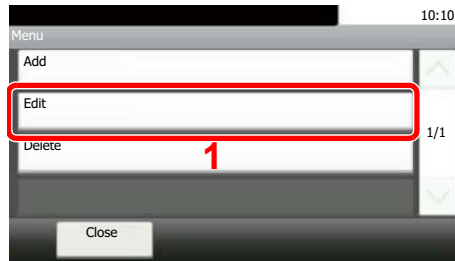

2 Edit the favorite.

[Name]

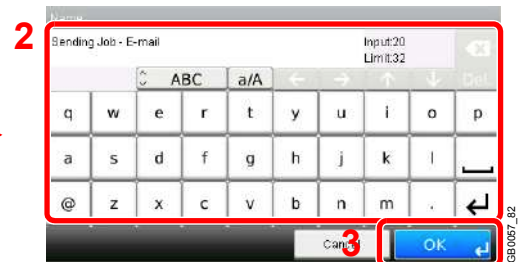
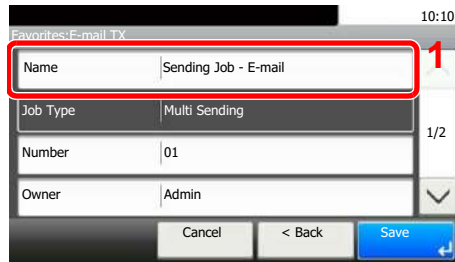

[Number]

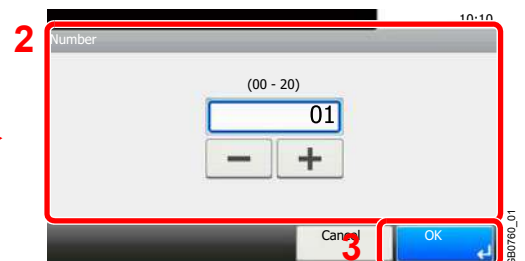
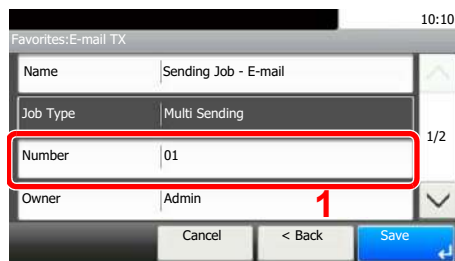

[Permission]

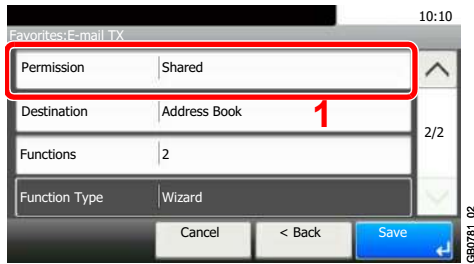

Configures permission settings for favorites to determine how they are shared with other users.

3 Register the favorite.

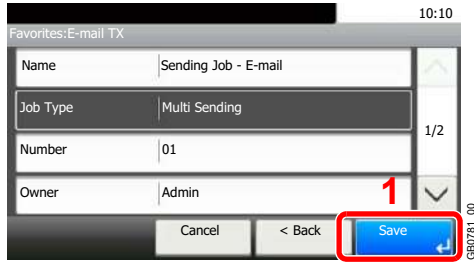

To delete

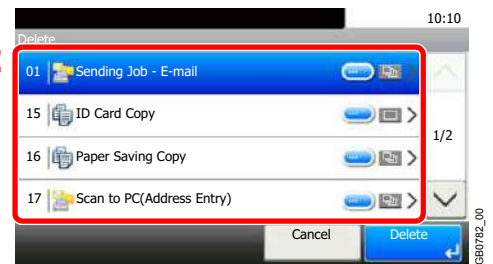

Select the favorite you wish to delete.

Using Favorites

Call up settings from a favorite.

1 Display the screen.

Favorites/ Application



2 Select a favorite.

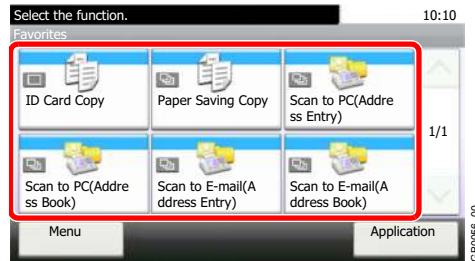

When using the wizard mode

1 The registered screens are displayed in order. Make the desired settings.

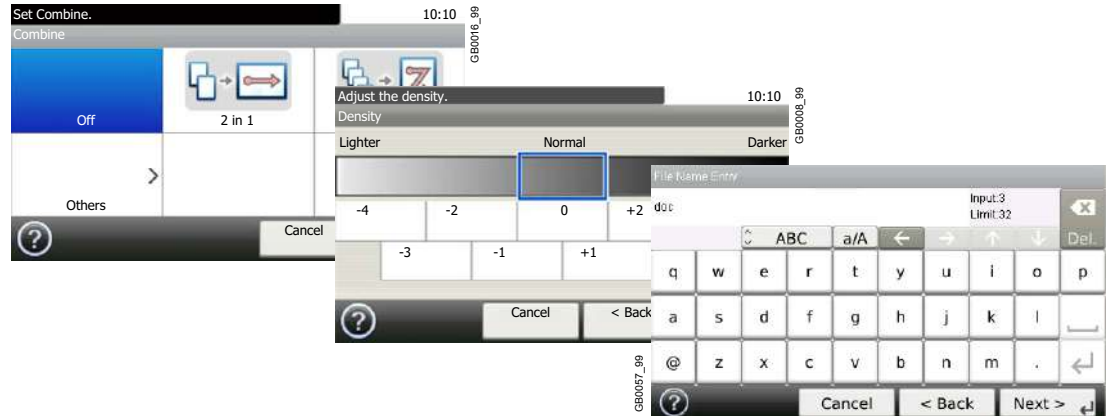

2 Confirm the settings and start the job.

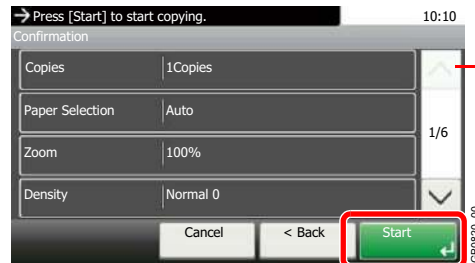

Use [V] or [^] to scroll up and down.



NOTE

To edit the settings, press [<Back] and make changes as desired.

When using the program mode

Select a favorite to call up registered settings.

Press the **Start** key to start the job.

Start

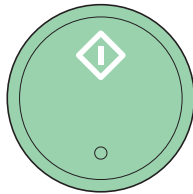

Shortcuts

Frequently used function screens can be registered as shortcuts so that they can be called up easily.

Registering Shortcuts

You can register up to 2 shortcuts for copying functions, sending functions, and functions set for document box.

The following types of shortcuts are available:

Private Shortcut	Private shortcuts are only available for use by the logged in user. They can only be set while using user login administration.
Shared Shortcut	Shared shortcuts can be used by all machine users. When using user login administration, shared shortcuts can only be set by users who have logged in as administrators.

1 Display the screen.

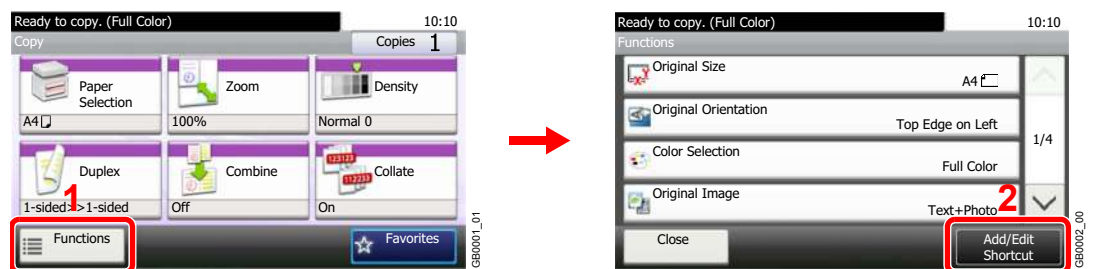

Press [Functions] on the Copy, Send, or Document Box screen and then [Add/Edit Shortcut].

2 Select [Add].

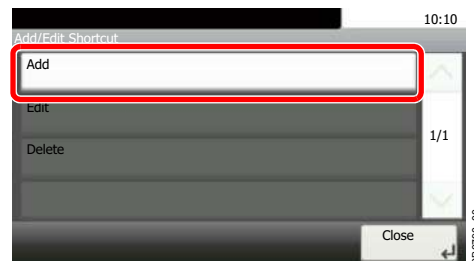

3 Select the key.

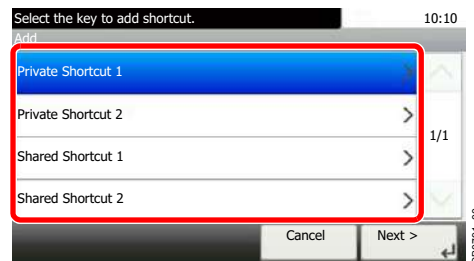

Select the key to which you wish to register the shortcut.



NOTE

If you select a shortcut number already registered, the currently registered shortcut can be replaced with a new one.

4 Select the function.

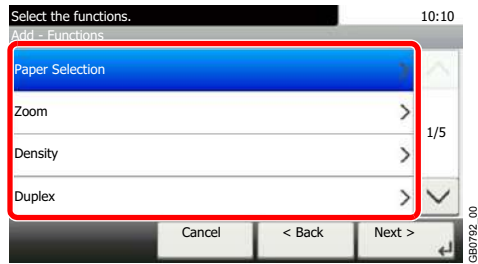

Select the function screen to display with the shortcut.

5 Enter the shortcut name.



Up to 24 characters can be entered.



Refer to *Character Entry Method* on page 11-8 for details on entering characters.

6 Register the shortcut.

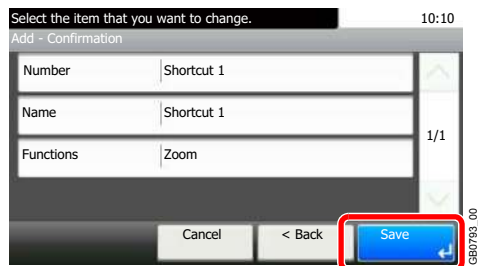

Confirm the settings and press [Save]

Editing and Deleting Shortcuts

Change shortcut number/name or delete shortcut.

1 Display the screen.

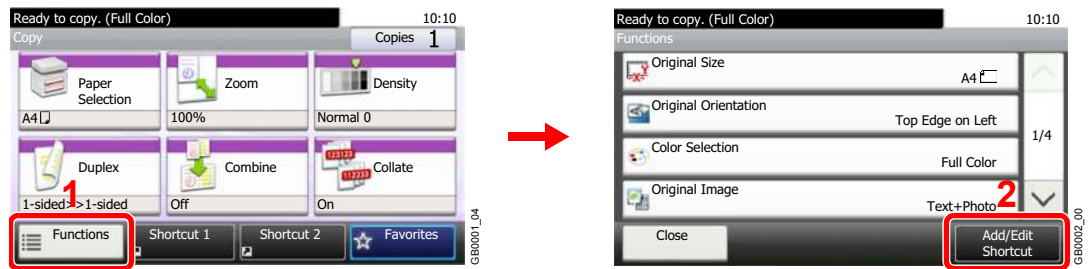

Press [Functions] on the Copy, Send, or Document Box screen and then [Add/Edit Shortcut].

2 Edit or delete a shortcut.

To edit a shortcut

1 Select the shortcut type and number you wish to edit.

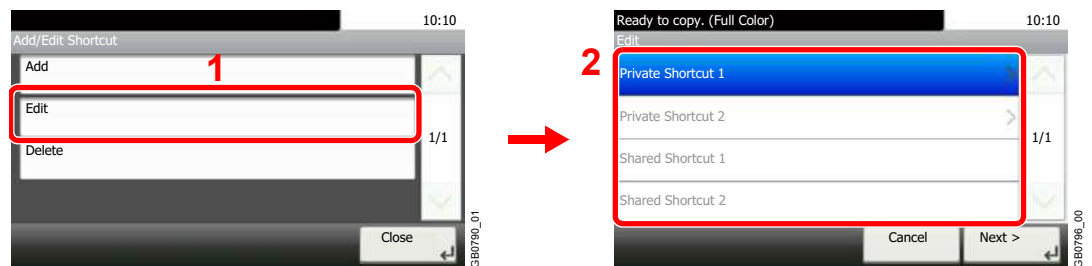

2 Edit the shortcut.

[No.]

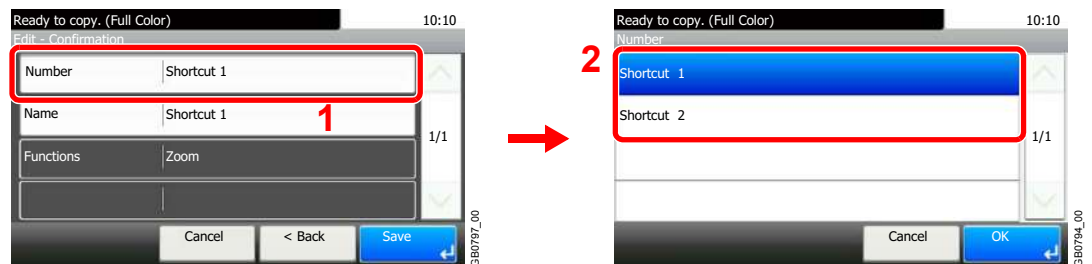

[Name]

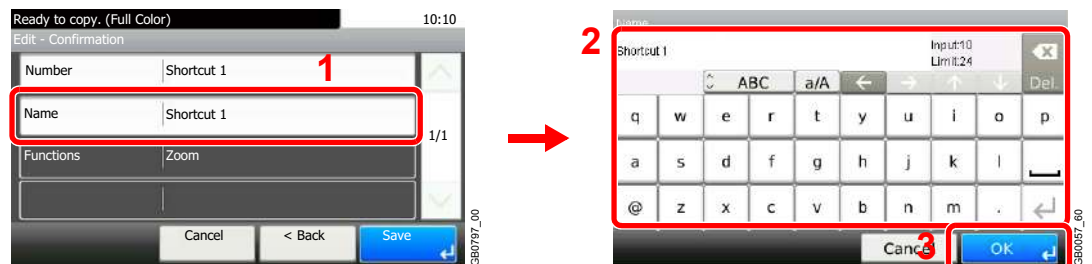

3 Register the shortcut.

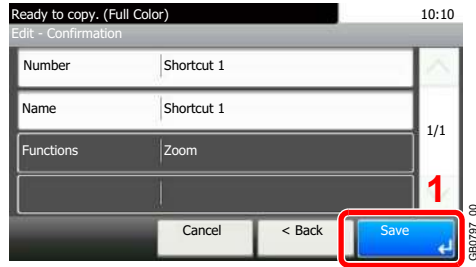

To delete

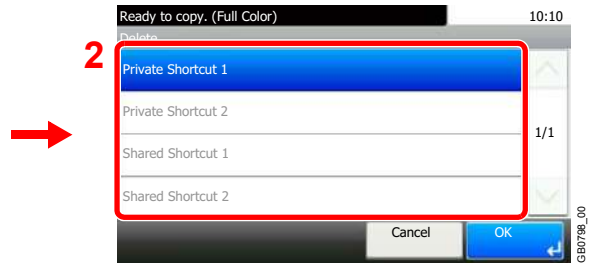

Select the shortcut you wish to delete.

Using Shortcuts

The registered shortcut will be displayed on the Copy, Send, FAX*, Print from USB Memory, or Save to USB Memory or Polling Box* initial screen. Pressing [Shortcut] will switch to the registered function's screen.

* Only on products with the fax function installed.



Quick Setup Wizard

Make the following basic settings as instructed by the Wizard:

Paper Setup	Sets the paper size and media type for the cassettes and the multi purpose tray.	
	1. Cassette 1	Cassette 1 - Paper Size*, Cassette 1 - Media Type
	2. Cassette 2**	Cassette 2 - Paper Size*, Cassette 2 - Media Type
	3. Cassette 3**	Cassette 3 - Paper Size*, Cassette 3 - Media Type
	4. MP Tray	MP Tray - Paper Size, MP Tray - Media Type
Energy Saver Setup	Configures sleep mode.	
	1. Sleep Mode	For Europe Sleep Mode - Sleep Timer Sleep Mode - Sleep Rules Except for Europe Sleep Mode - Sleep Timer Sleep Mode - Sleep Level
	2. Low Power Mode	Low Power Mode - Low Power Timer
Network Setup	Configures basic network settings.	
	1. Network	Network - Obtain IP Address
		Network - IP Address
		Network - Subnet Mask
		Network - Default Gateway
FAX Setup***	Configures basic fax settings.	
1. Dialing/RX Mode	Dialing/RX Mode - Dialing Mode Dialing/RX Mode - Reception Mode Dialing/RX Mode - Auto (DRD)****	
2. Local FAX Info.	Local FAX Info. - Local FAX Name Local FAX Info. - Local FAX Number Local FAX Info. - Local FAX ID Local FAX Info. - Print Position	
3. Sound Volume	Speaker Volume, Monitor Volume, Job Finish	
4. Rings	Normal, Answering Machine, FAX/TEL Switch*****	
5. Redial	Redial - Retry Times	

* This function is displayed when the size dial on the cassette is set to Other.

** This function is displayed when the optional paper feeder is installed.

*** Only on products with the fax function installed.

**** Auto (DRD) is available for some countries.

*****For FAX/TEL Switch, this change is possible with some countries.

1 Display the screen.

◆ System Menu / Counter

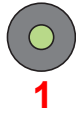

2 Select a function.

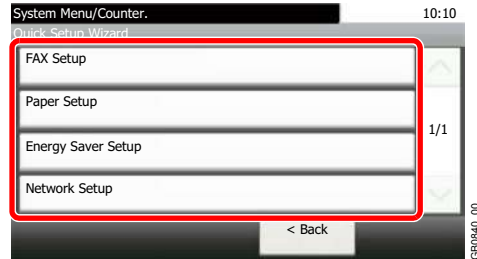

3 Configure the function.



Start the wizard. Follow the instructions on the screen to configure settings.

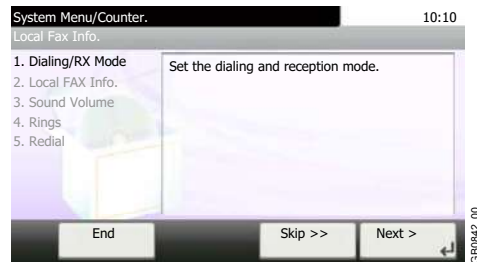

NOTE

If you experience difficulty configuring the settings, refer to *Help Screen on page 3-31*.

[End]	Exits the wizard. Settings configured so far are applied.
[<< Previous]	Returns to the previous item.
[Skip >>]	Advances to the next item without setting the current item.
[Next >]	Advances to the next screen.
[< Back]	Returns to the previous screen.
[Finish]	Register the settings and exit the wizard.

Help Screen

If you have difficulty operating the machine, you can check how to operate it using the touch panel. When the [?] (help) is displayed on the touch panel, you can press it to display the Help screen.

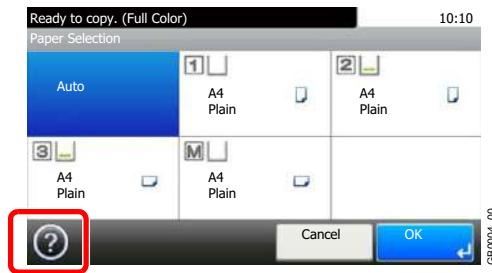

How to read the screen

A screenshot of the 'Paper Selection' help screen. The screen title is 'Ready to copy. (Full Color)' and the time is '10:10'. The screen displays the following text: '? Paper Selection', 'Select the cassette or multi purpose tray with the desired paper size.', 'Auto: Automatically selects the appropriate paper size.', 'Cassette 1: Selects the paper in cassette 1.', 'Cassette 2: Selects the paper in cassette 2.', 'Cassette 3: Selects the paper in cassette 3.'. At the bottom, there is a close button (an 'X' in a circle) and a scroll bar with '1/2' in the center. Red lines and boxes highlight these elements, with corresponding text labels.

Help titles

Displays information about functions and machine operation.

Closes the Help screen and returns to the original screen.

Scrolls up and down when the help text cannot be displayed in its entirety on a single screen.

Canceling Jobs

Cancel any print or send job being executed.

- 1 Press the Stop key.

Stop



- 2 Cancel a job.

When there is a job is being scanned

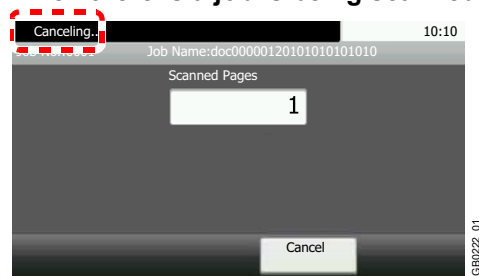

Canceling... will be displayed, and the current job will be canceled.

When there is a job printing or on standby

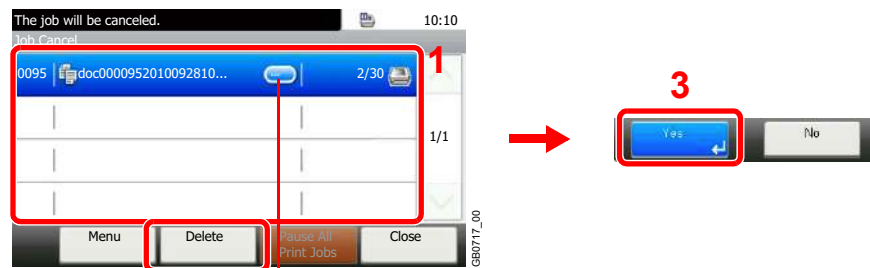

- 2 Displays details for individual jobs.

Select the job you wish to cancel and press [Delete].



NOTE

The current print job is temporarily interrupted. Continues without temporarily interrupting jobs being sent.

You can also cancel executing jobs and jobs on standby after checking their status. Refer to *Status / Job Cancel* on page 8-1.

Canceling printing from a computer

To cancel a print job executed using the printer driver before the printer begins printing, do the following:

- 1 Double-click the printer icon () displayed on the taskbar at the bottom right of the Windows desktop to display a dialog box for the printer.
- 2 Click the file for which you wish to cancel printing and select **Cancel** from the **Document** menu.

Using Various Functions

This section describes common functionality that can be configured for copying, sending, and the document box.

1 Display the screen.

Copy



Send



Press the key of each function.

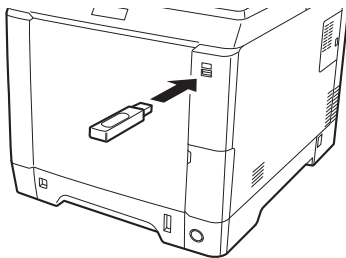

When using USB memory, plug it into the USB memory slot.

Press [Yes] on the displayed screen.

When printing from USB memory, select the file to be printed and press [Print].

When storing a document to USB memory, select the folder where the file will be stored and press [Menu] and then [Store File].



For details, refer to *Printing Documents Stored in Removable USB Memory* on page 7-17 or *Saving Documents to USB Memory (Scan to USB)* on page 7-20.



NOTE

If the touch panel is turned off, press the **Energy Saver** key and wait for the machine to warm up.

2 Select the functions.

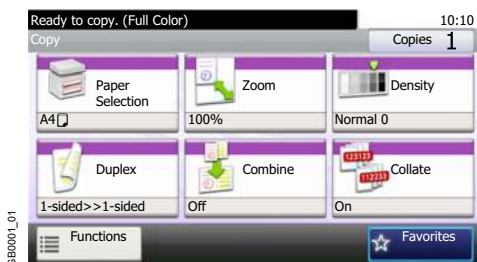

Select the functions to use.

Press [Functions] to display all the functions.



Refer to *Common Functionality* on page 3-34.

Common Functionality

Functionality related to originals

What do you want to do?	Reference Page
Specify the original size.	Original Size ► page 3-35
Specify the original orientation to scan in the correct direction.	Original Orientation ► page 3-36
Automatically scan 2-sided originals.	Duplex ► page 3-37
Scan a large number of originals separately and then produce as one job.	Continuous Scan ► page 3-39

Functionality related to document quality

What do you want to do?	Reference Page
Specify the paper size and type.	Paper Selection ► page 3-41
Collate the output documents in page order.	Collate ► page 3-42
Adjust the density.	Density ► page 3-43
Set the resolution at which to scan originals.	Scan Resolution ► page 3-44
Select original image type for best results.	Original Image ► page 3-45
EcoPrint saves toner when printing.	EcoPrint ► page 3-46
Emphasize the outline of texts or lines. Blur the image outline.	Sharpness ► page 3-47
Darken or lighten the background (i.e., the area with no text or images) of originals.	Background Density Adjust ► page 3-48
Enlarge or shrink originals according to the sending or storing size.	Zoom ► page 3-49
Select the file format for images being sent or stored.	File Format ► page 3-50
Change the color mode.	Color Selection ► page 3-53
Send notice by e-mail when a job is complete.	Job Finish Notice ► page 3-54
Add a file name to the job to easily check its status.	File Name Entry ► page 3-56
Suspend the current job and override it to give a new job top priority.	Priority Override ► page 3-57

Original Size



Specify the original size to be scanned.

Metric	Select from A4, A5, A6, B5, B6, Folio or 216 × 340mm.
Inch	Select from Letter, Legal, Statement, Executive, or Oficio II.
Others	Select from 16K, ISO B5, Envelope #10, Envelope #9, Envelope #6, Envelope Monarch, Envelope DL, Envelope C5, Hagaki, Ofukuhagaki, Youkei 4, Youkei 2, or Custom*

* For instructions on how to specify the custom original size, refer to *Custom Original Size on page 9-9*.

NOTE

Be sure to always specify the original size when using custom size originals.

1 Display the screen.

1 Referring to *Using Various Functions on page 3-33*, display the screen.

2 Press [Functions] and then [Original Size].

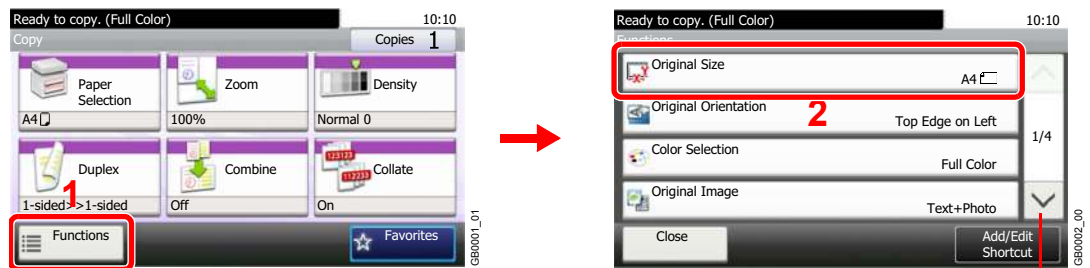

Use [∨] or [∧] to scroll up and down.

2 Select the original size.

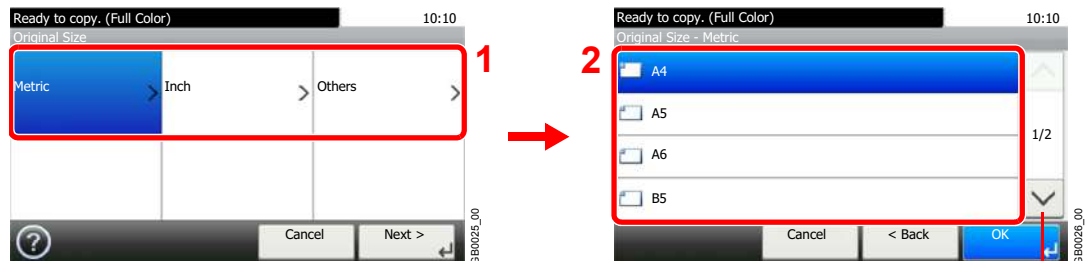

Use [∨] or [∧] to scroll up and down.

Select the original size.

Original Orientation



Select the orientation of the original document top edge to scan correct direction.

To use any of the following functions, the document's original orientation must be set.

- Duplex
- Combine

When placing originals on the platen

Top Edge on Top

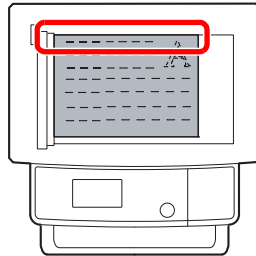

Top Edge on Left

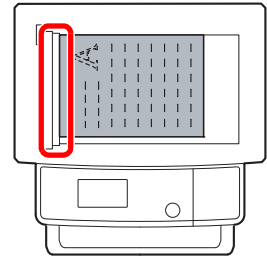

When placing originals on the document processor

Top Edge on Top

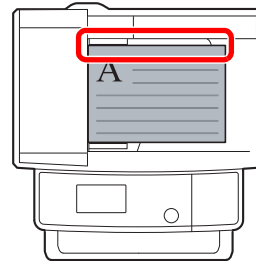

Top Edge on Left

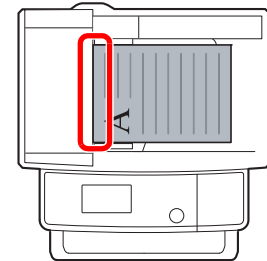

1 Display the screen.

1 Referring to *Using Various Functions* on page 3-33, display the screen.

2 Press [Functions] and then [Original Orientation].

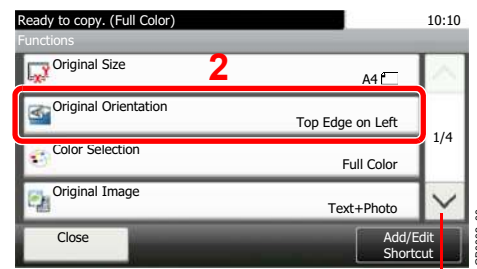
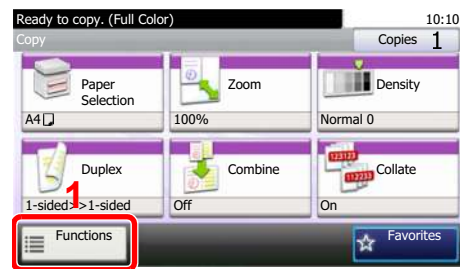

Use [∨] or [∧] to scroll up and down.

2 Select the function.

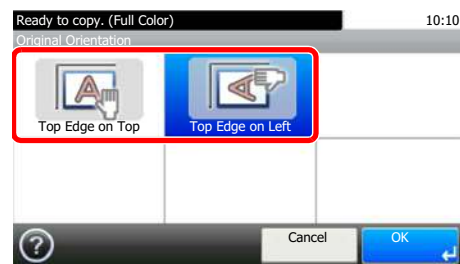

Select the original orientation.

Duplex



Select the type and orientation of the binding based on the original.

1-sided			Set when using a 1-sided sheet original.
2-sided			Set when using a 2-sided sheet original that will be bound on the left or right.
Other Settings	Duplex	1-sided	Set when using a 1-sided sheet original.
		2-sided (Binding Left/Right)	Set when using a 2-sided sheet original that will be bound on the left or right.
		2-sided (Binding Top)	Set when using a 2-sided sheet original that will be bound at the top.
	Original Orientation*		Select the orientation of the original document top edge to scan correct direction.

* This function is displayed when [2-sided (Binding Left/Right)] or [2-sided (Binding Top)] is selected.

1 Display the screen.

1 Referring to *Using Various Functions* on page 3-33, display the screen.

2

Send

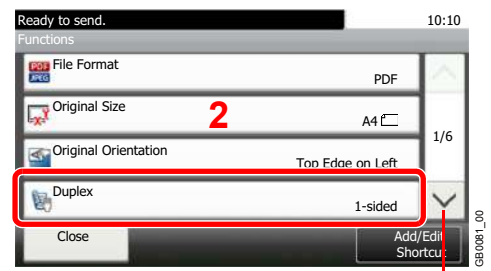

Use [∨] or [∧] to scroll up and down.

Scan to USB

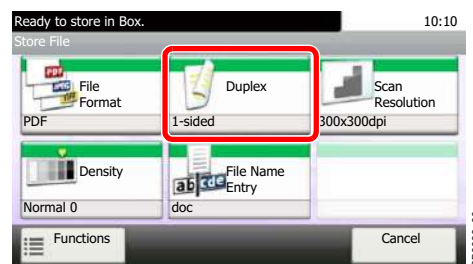

2 Select the type of original.

[2-sided]

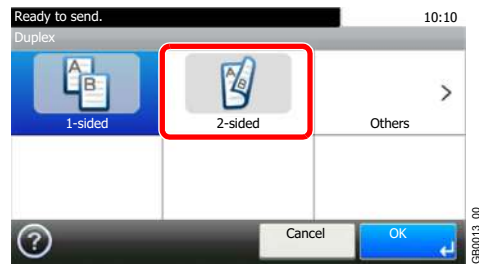

[Others]

1



2 Select the type of original.

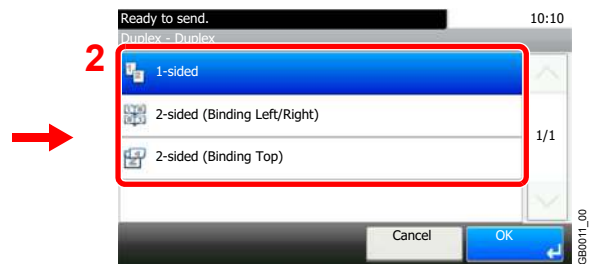
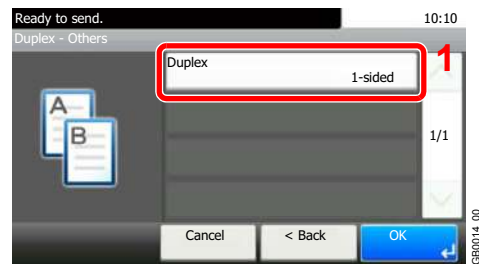

3 Select the original orientation.

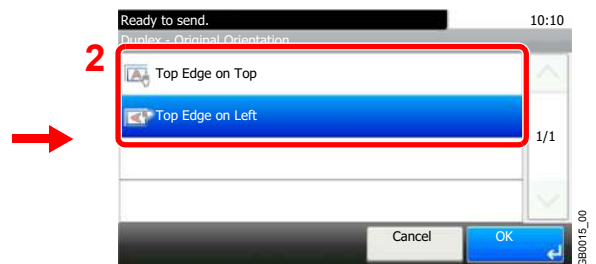
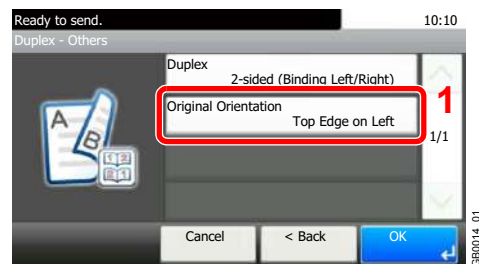

Continuous Scan



Scan a large number of originals in separate batches and then produce as one job. Originals will be scanned continuously until you press [Finish Scan].

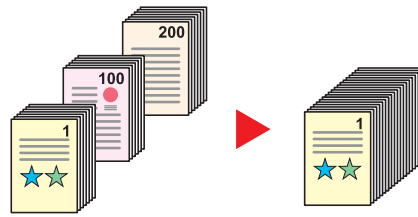

1 Display the screen.

1 Referring to *Using Various Functions* on page 3-33, display the screen.

2 Press [Functions] and then [Continuous Scan].

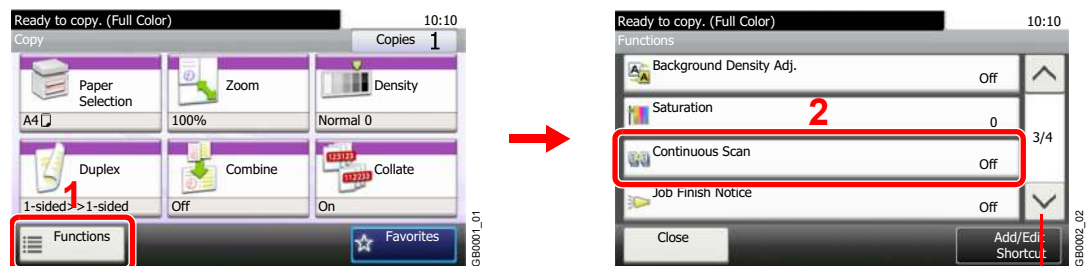

Use [∇] or [∧] to scroll up and down.

2 Select the function.

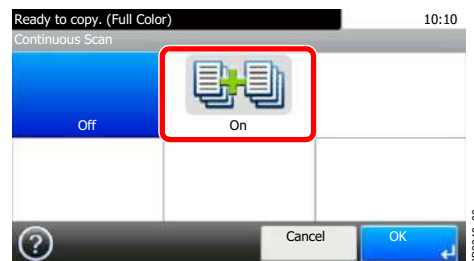

3 Scan the originals.

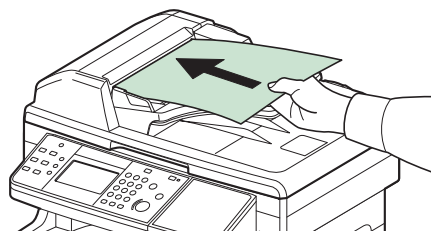

Start

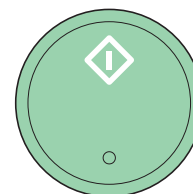

Load the original and press the **Start** key to start scanning.

Once the original has been scanned, load the next original and press the **Start** key. Use the same procedure to scan any remaining originals.

4 Finish scanning.

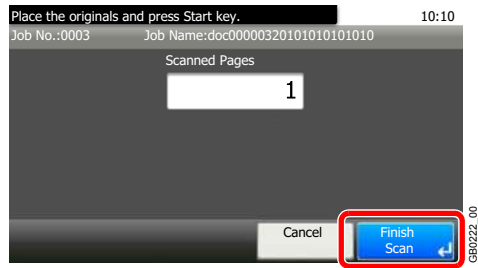

Start copying, sending, or storing.

Paper Selection



Select the cassette or multi-purpose tray that contains the required paper size.

NOTE

Specify in advance the size and type of the paper loaded in the cassette (refer to *Quick Setup Wizard* on page 3-29).

1 Display the screen.

1 Referring to *Using Various Functions* on page 3-33, display the screen.

2 Press [Paper Selection].

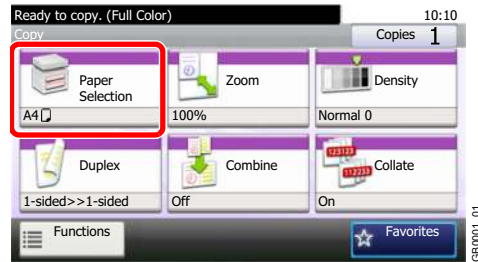

2 Select the paper source.

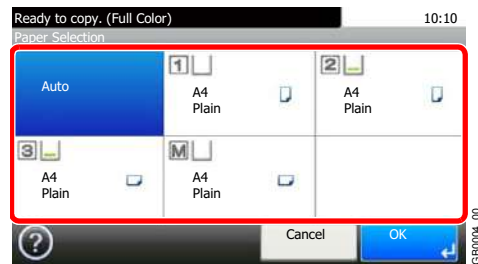

If [Auto] is selected, the paper matching the size of the original is selected automatically.

[2] (Cassette 2) and [3] (Cassette 3) are displayed when the optional paper feeder is installed. [M] indicates the MP tray.

Collate



Collate the output by page.

Collate



Scan multiple originals and deliver complete sets of copies as required according to page number.

1 Display the screen.

1 Referring to *Using Various Functions on page 3-33*, display the screen.

2 Press [Collate].

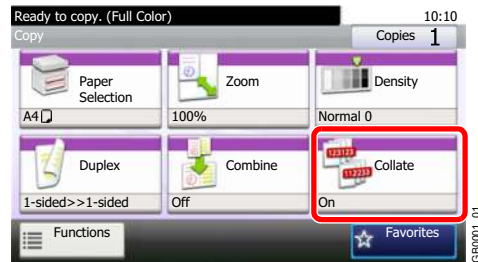

2 Select the function.

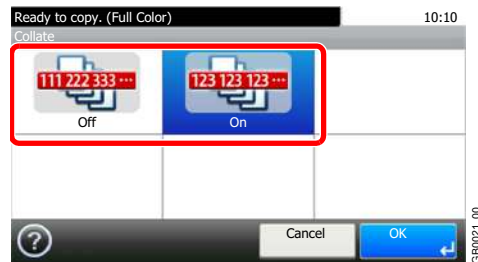

Density

Adjust density using 9 levels.



1 Display the screen.

1 Referring to *Using Various Functions* on page 3-33, display the screen.

2

Copy

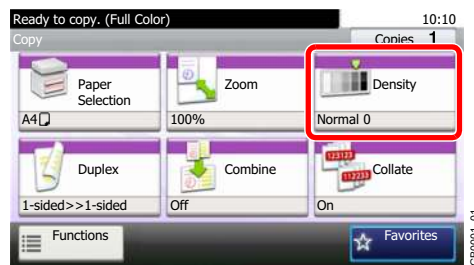

Scan to USB

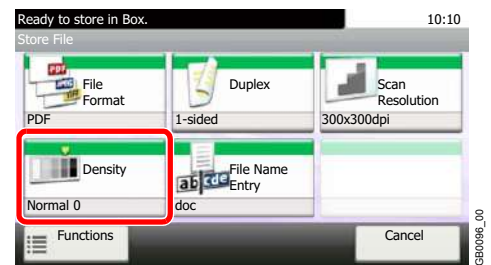

Send

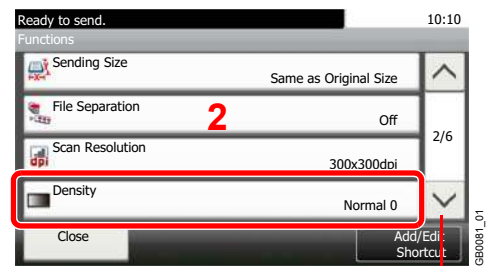

Use [∨] or [∧] to scroll up and down.

2 Adjust density.



Press [-4] to [+4] (*Lighter - Darker*) to adjust density.

Scan Resolution



Select fineness of scanning resolution.

The selectable resolution is [200 × 100dpi], [200 × 200dpi Fine], [200 × 400dpi Super], [300 × 300dpi], [400 × 400dpi Ultra], or [600 × 600dpi].

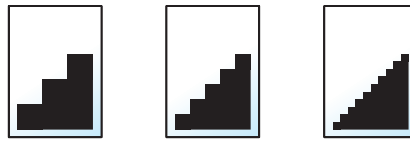

NOTE

The larger the number, the better the image resolution. However, better resolution also means larger file sizes and longer send times.

1 Display the screen.

1 Referring to *Using Various Functions on page 3-33*, display the screen.

2

Send

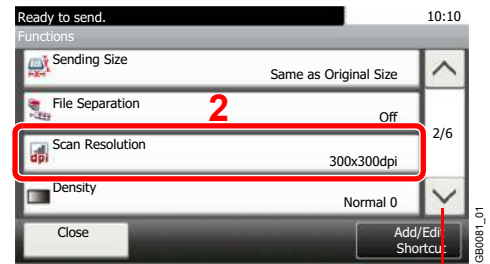

Use [∨] or [∧] to scroll up and down.

Scan to USB

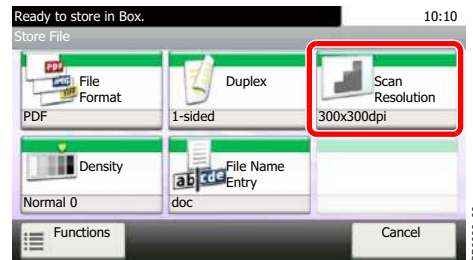

2 Select the resolution.

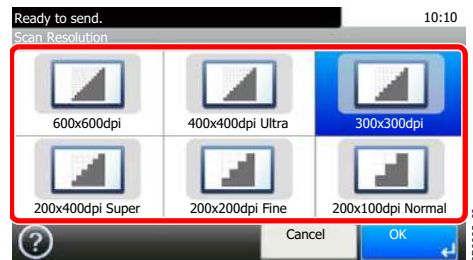

Original Image



Select original image type for best results.

Text+Photo		Best for originals which contain a mixture of text and photos.
Photo		Best for photographs.
Text		Sharply renders pencil text and fine lines.
Graphic/Map*		Best for graphics and maps.
Printer Output*		Best for documents printed on this machine originally.
Text (for OCR)**		For documents to be read by OCR.

* This function is displayed while copying.

** This function is displayed when the color mode is [Auto (Color/B & W)] or [Black & White] (when sending or storing).

1 Display the screen.

1 Referring to *Using Various Functions on page 3-33*, display the screen.

2 Press [Functions] and then [Original Image].

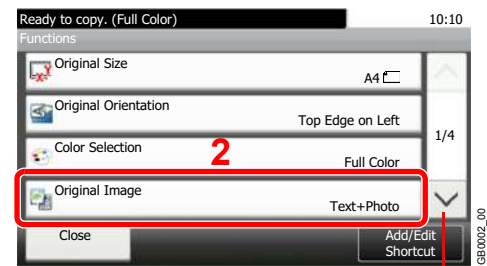
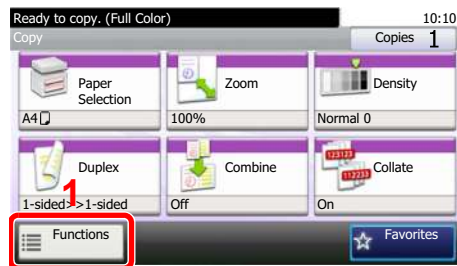

Use [∨] or [∧] to scroll up and down.

2 Select the image quality.

Copy



Send/Scan to USB

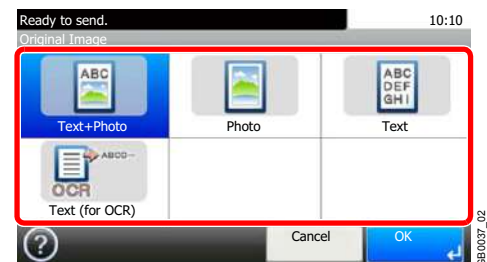

EcoPrint



Use EcoPrint to save toner when printing. Use this function for test copies or any other occasion when high quality print is not required.

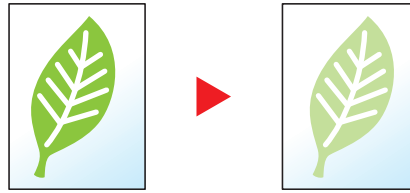

1 Display the screen.

1 Referring to *Basic Operation on page 4-2*, display the screen.

2

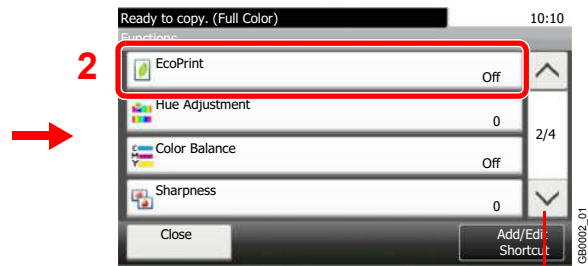
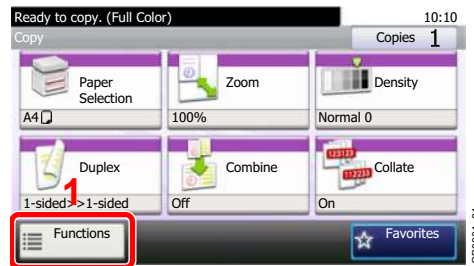

Use [∨] or [∧] to scroll up and down.

2 Select the function.

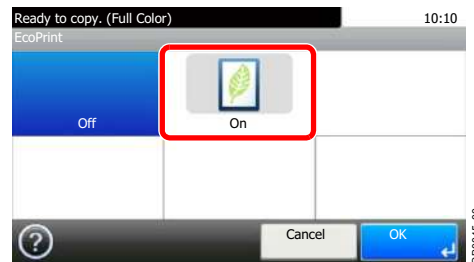

Sharpness



Adjust the sharpness of the image.

When copying penciled originals with rough or broken lines, clear copies can be taken by adjusting sharpness toward [Sharpen]. When copying images made up of patterned dots such as magazine photos, in which moire* patterns appear, edge softening and weakening of the moire effect can be obtained by setting the sharpness toward [Blur].

* Patterns that are created by irregular distribution of halftone dots.

Less Sharp



Original



More Sharp



1 Display the screen.

1 Referring to *Using Various Functions* on page 3-33, display the screen.

2 Press [Functions] and then [Sharpness].

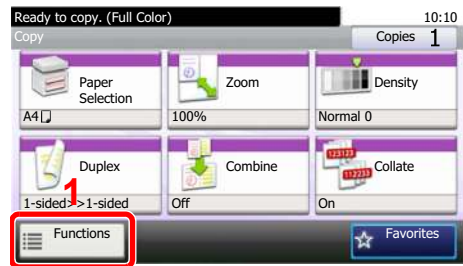

Use [∨] or [∧] to scroll up and down.

2 Adjust the sharpness.

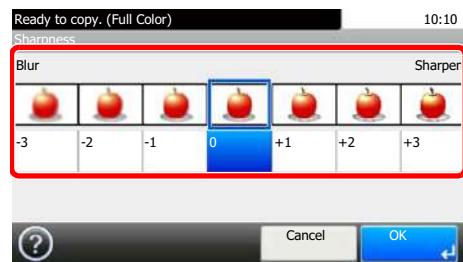

Press [-3] to [+3] (*Blur - Sharpen*) to adjust the sharpness.

Background Density Adjust



Remove dark background from originals, such as newspapers.

Off	Do not use this function.
Auto	Adjusts the density automatically based on the original.
Manual	Manually adjust the density.

1 Display the screen.

- 1 Referring to *Using Various Functions* on page 3-33, display the screen.
- 2 Press [Functions] and then [Background Density Adj.].

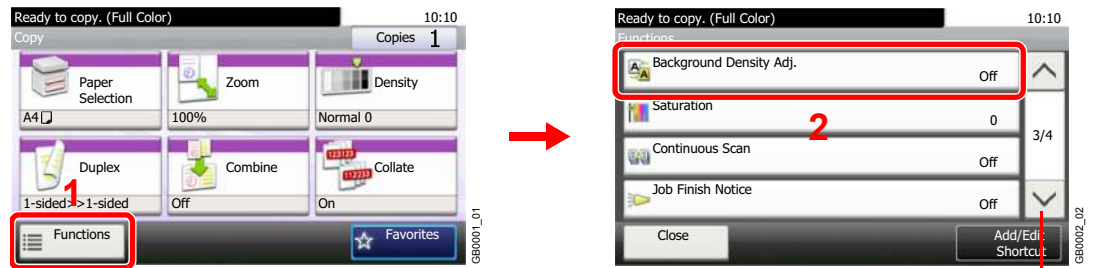

Use [∨] or [∧] to scroll up and down.

2 Adjusts the background density.

[Auto]

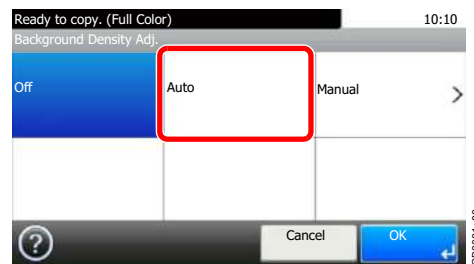

[Manual]

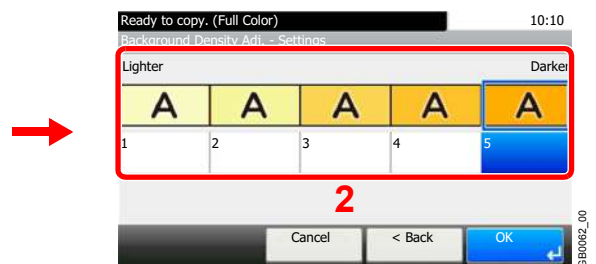
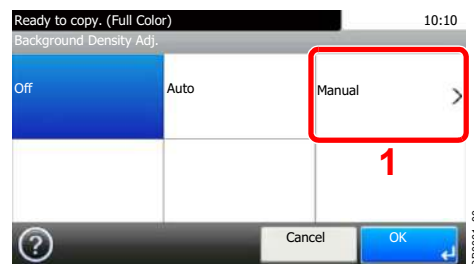

Press [1] to [5] (*Lighter - Darker*) to adjust the background density.

Zoom



Reduce or enlarge original to send or store size.

100%	Reproduces the original size.
Auto	Adjust the image to match the send or store size.

NOTE
Original Size (page 3-35), *Sending Size* (page 6-37), *Storing Size* (page 7-30), and *Zoom* are related to each other.

Refer to *Sending Size on page 6-37* and *Storing Size on page 7-30*.

1 Display the screen.

1 Referring to *Using Various Functions on page 3-33*, display the screen.

2

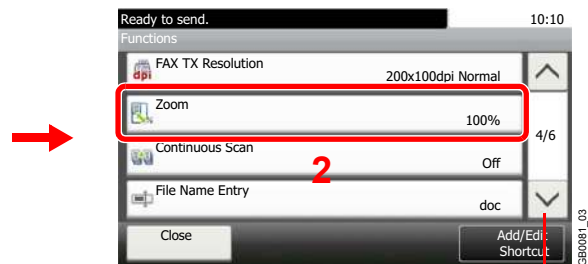

Use [∨] or [∧] to scroll up and down.

Press [Functions] and then [Zoom].

2 Select the function.

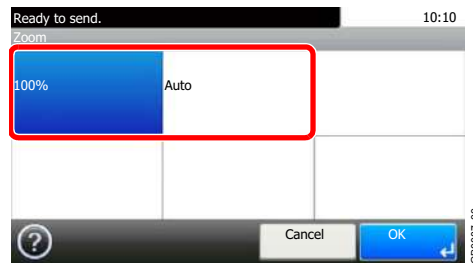

File Format



Specify the image file format. In addition, you can adjust the image quality level.

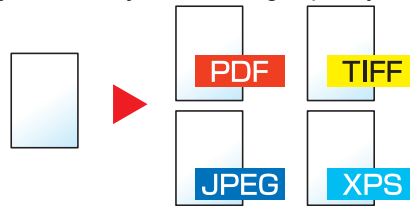

PDF		Saves or sends a PDF file. You can specify the format that comply with PDF/A.
High Comp. PDF		Saves or sends a High Comp. PDF file.
TIFF		Saves or sends a TIFF file.
JPEG		Saves or sends a JPEG file. Each page will be saved individually.
XPS		Saves or sends a file in XPS.
Others	File Format	Select from PDF, TIFF, JPEG, and XPS.
	Image Quality	Set the image quality from [1] to [5] (<i>Low Quality - High Quality</i>). If you selected [High Comp. PDF], adjust with [Compression Ratio Priority], [Standard], or [Quality Priority].
	PDF/A*	Set PDF/A from [PDF/A-1a] and [PDF/A-1b].

* This setting is displayed only when [PDF] has been selected as the file format.

1 Display the screen.

1 Referring to *Using Various Functions* on page 3-33, display the screen.

2

Send

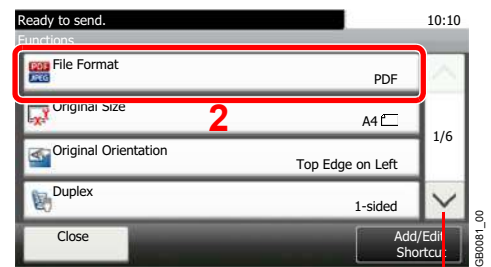

Use [∨] or [∧] to scroll up and down.

Scan to USB

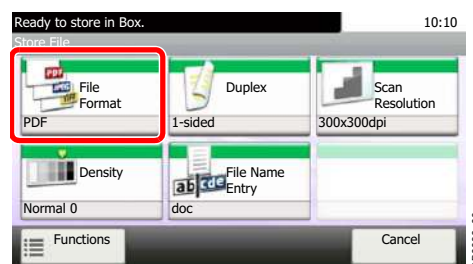

2 Select the file format.

[PDF], [High Comp. PDF], [TIFF], [JPEG], or [XPS]

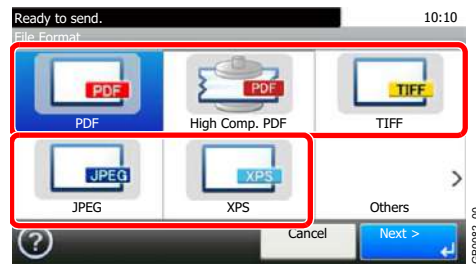

[Others]

1

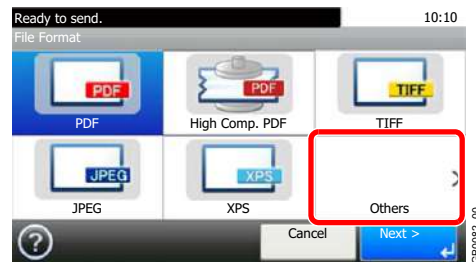

2 Select the file format.

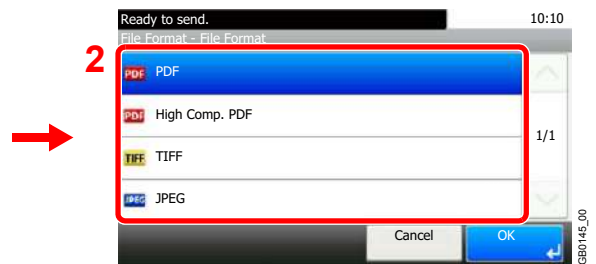
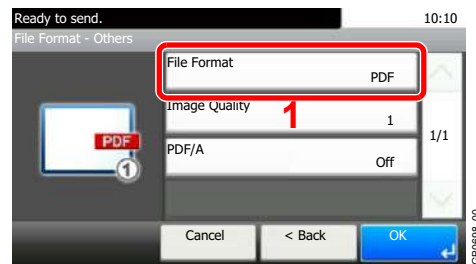

3 Set the image quality.

[PDF], [TIFF], [JPEG], or [XPS]

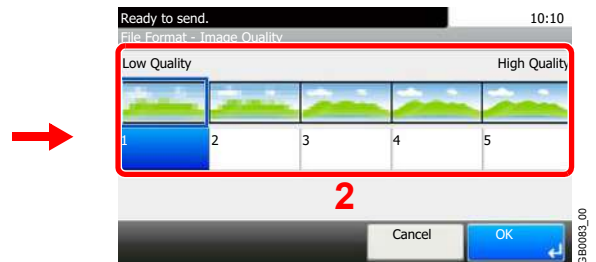
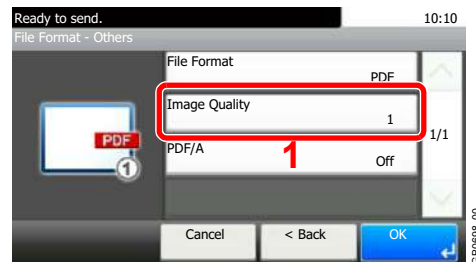

[High Comp. PDF]

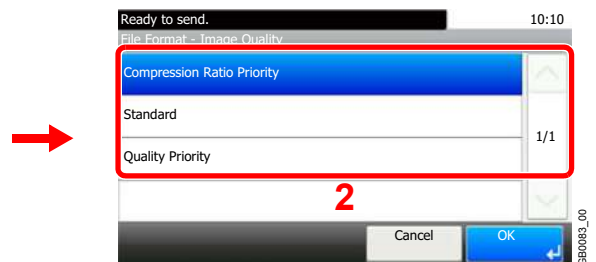
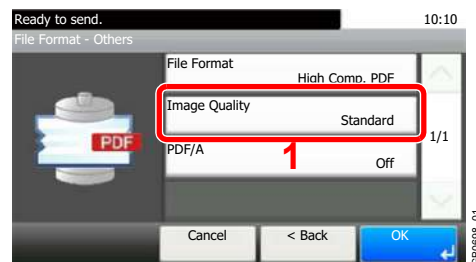

4 Set PDF/A.

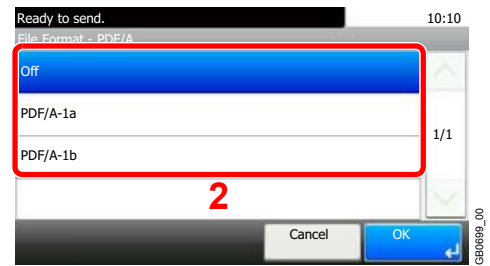
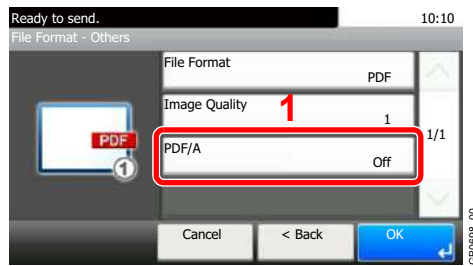

Color Selection



Select the color mode setting.

Auto Color*	Automatically recognizes whether a document is color or black and white, and then scans the document.
Auto (Color/Gray)**	Automatically detects whether the document is color or black and white, and scan color documents in Full Color and black and white documents in Grayscale.
Auto (Color/B & W)**	Automatically recognize whether the document is color or black and white, and scan color documents in Full Color and black and white documents in Black and White.
Full Color	Scan document in full color.
Grayscale**	Scan document in grayscale for smoother and finer finish.
Black & White	Scan document in black and white. File size is smaller than Full Color or Grayscale.

* This function is displayed while copying or printing.

** This function is displayed while sending or storing.

1 Display the screen.

1 Referring to *Using Various Functions* on page 3-33, display the screen.

2 Press [Functions] and then [Color Selection].

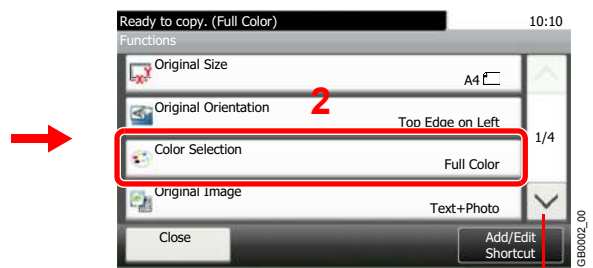
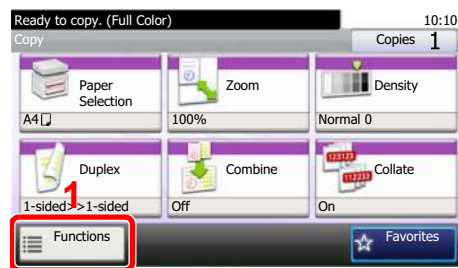

Use [∨] or [∧] to scroll up and down.

2 Select the color mode.

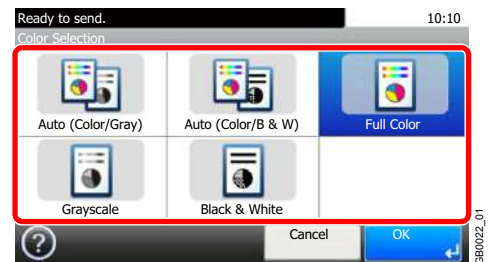

Job Finish Notice



Send e-mail notice when a job is complete.

User can be notified of the completion of a copy job while working at a remote desk, saving the time spent waiting beside the machine for copying to finish.



NOTE

PC should be configured in advance so that E-mail can be used.

Email can be sent to a single destination.

1 Display the screen.

1 Referring to *Using Various Functions* on page 3-33, display the screen.

2 Press [Functions] and then [Job Finish Notice].

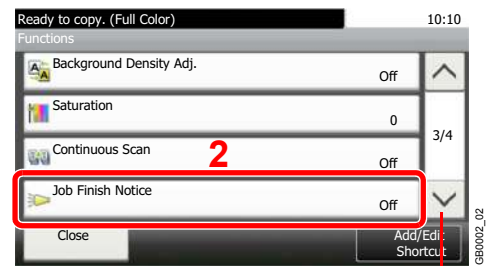
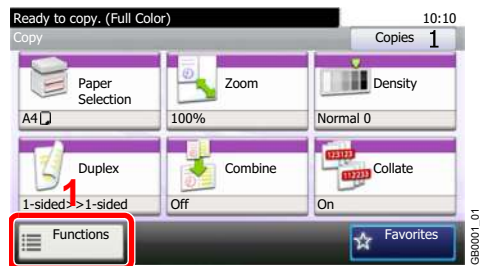

Use [∨] or [∧] to scroll up and down.

2 Select the function.

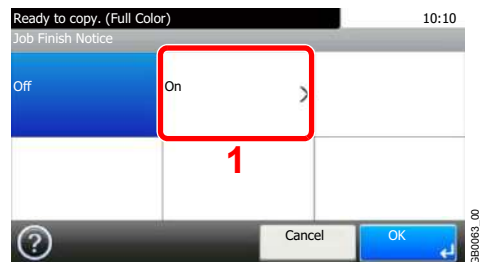

Allows you to add, edit, or delete a destination.

3 Select the destination.

Select an e-mail address from the address book.

Searches by destination name.

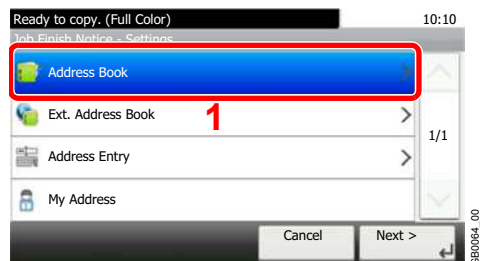

Allows you to search for and sort destinations.

Displays details for individual destinations.

Select the e-mail address from an external address book.

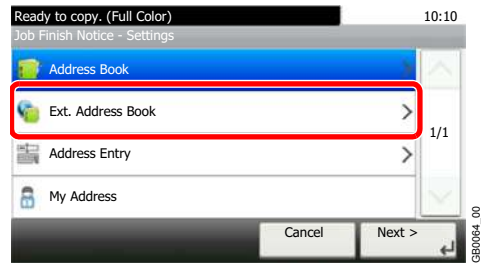

For details on the External Address Book, refer to *Command Center RX User Guide*.

Enter the e-mail address directly.

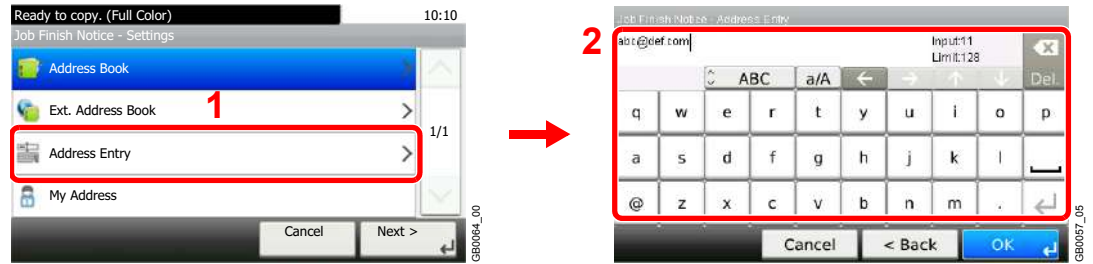

Up to 128 characters can be entered.

Refer to *Character Entry Method on page 11-8* for details on entering characters.

Uses the e-mail address of the logged in user.

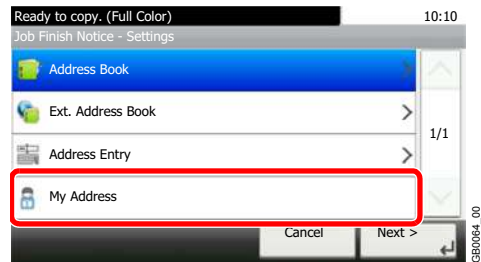

This setting is displayed when using user login administration.

4 Accept the destinations.

Press [OK].

File Name Entry



Add a file name. Additional information such as Job No. and Date and Time can also be set. You can check a job history or job status using the job name, date and time, or job number specified here.

1 Display the screen.

1 Referring to *Using Various Functions on page 3-33*, display the screen.

2 Copy/Send

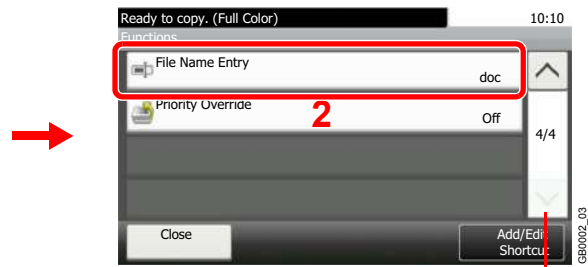
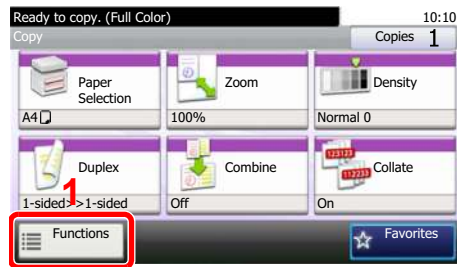

Use [∨] or [∧] to scroll up and down.

Scan to USB

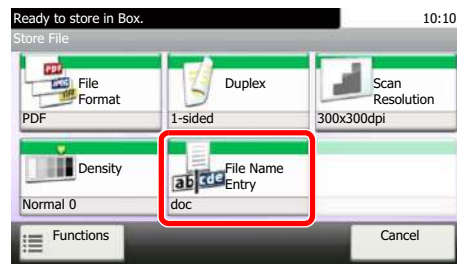

2 Enter the name.

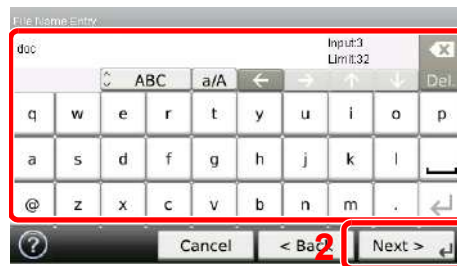

Up to 32 characters can be entered.

 Refer to *Character Entry Method on page 11-8* for details on entering characters.

3 Add other information.

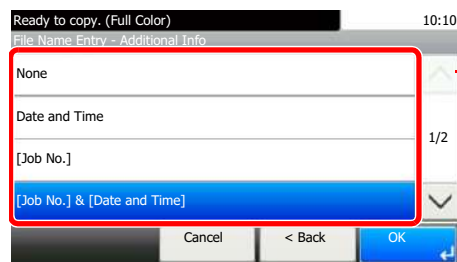

Use [∨] or [∧] to scroll up and down.

Priority Override



Suspend the current job and give a new job top priority. The suspended job resumes after the other job is finished.

NOTE

This function is not available if current job was an override.

Priority override may not be available depending on the status of the current print job and memory usage.

1 Display the screen.

1 Referring to *Using Various Functions* on page 3-33, display the screen.

2 Press [Functions] and then [Priority Override].

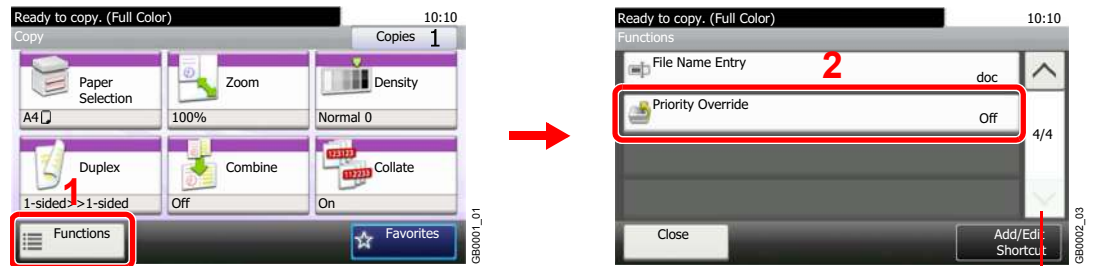

Use [∨] or [∧] to scroll up and down.

2 Select the function.

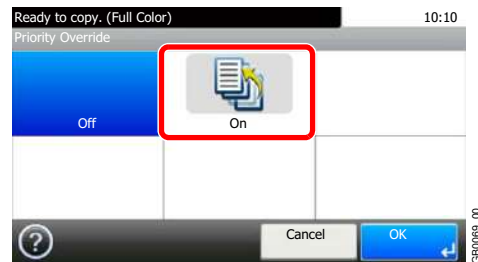

4 Copying

This chapter explains the following topics:

Basic Operation	4-2
Copying Functions	4-4
Zoom	4-5
Duplex	4-7
Combine	4-10
Hue Adjustment	4-13
Color Balance	4-14
Saturation	4-15

Basic Operation

1 Press the Copy key



NOTE

If the touch panel is turned off, press the **Energy Saver** key and wait for the machine to warm up.

2 Place the originals

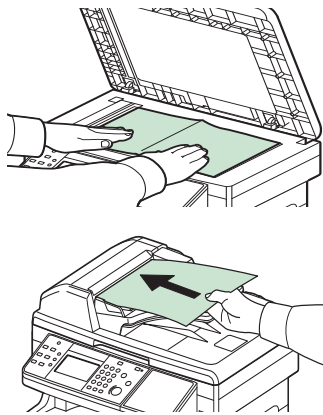

For details, refer to *Loading Originals* on page 3-10.

3 Selecting color mode



Auto Color	Automatically recognizes whether a document is color or black & white and then scans the document.
Full Color	Scans all documents in full color.
Black & White	Scans all documents in black & white.

4 Selecting the functions



Select the copier's functions to use.

Press [Functions] to display other functions.



Refer to *Copying Functions* on page 4-4.

5 Entering the copy quantity



NOTE

Press the **Clear** key to change the copy quantity.

6 Start copying

Start

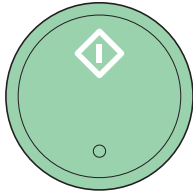

Press the **Start** key to start copying.

Copying Functions

Copy screen shows the commonly used functions. By pressing [Functions], other selectable functions will be shown as a list. Use [∨] or [∧] to select the function.

What do you want to do?	Reference Page
Specify the paper size and type.	Paper Selection ▶ page 3-41
Reduce or enlarge the original.	Zoom ▶ page 4-5
Adjust the density.	Density ▶ page 3-43
Copy on both sides of the paper.	Duplex ▶ page 4-7
Combine 2 or 4 originals into 1 sheet.	Combine ▶ page 4-10
Collate the output documents in page order.	Collate ▶ page 3-42
Specify the original size.	Original Size ▶ page 3-35
Specify the original orientation to scan in the correct direction.	Original Orientation ▶ page 3-36
Change the color mode.	Color Selection ▶ page 3-53
Select original image type for best results.	Original Image ▶ page 3-45
Save toner when printing.	EcoPrint ▶ page 3-46
Make a copy after changing the appearance of the original's colors.	Hue Adjustment ▶ page 4-13
Adjust colors, for example by strengthening cyan or magenta tones.	Color Balance ▶ page 4-14
Emphasize the outline of texts or lines. Blur the image outline.	Sharpness ▶ page 3-47
Darken or lighten the background (i.e., the area with no text or images) of originals.	Background Density Adjust ▶ page 3-48
Make a copy with more vivid colors.	Saturation ▶ page 4-15
Scan a large number of originals separately and then produce as one job.	Continuous Scan ▶ page 3-39
Send notice by e-mail when a job is complete.	Job Finish Notice ▶ page 3-54
Add a file name to the job to easily check its status.	File Name Entry ▶ page 3-56
Suspend the current job and override it to give a new job top priority.	Priority Override ▶ page 3-57

Zoom

Adjust the zoom to reduce or enlarge the image.

Auto

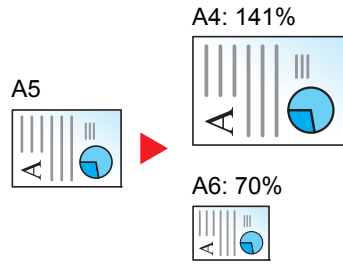

Adjusts the image to match the paper size.

Standard Zoom

Adjusts the image to match present sizes.

Model	Zoom Level (Original Copy)	Model	Zoom Level (Original Copy)
Inch Models	400% (Max.) 200% 129% (STMT >> Letter) 100% 78% (Legal >> Letter) 64% (Letter >> STMT) 50% 25% (Min.)	Metric Models	400% (Max.) 200% 141% (A5 >> A4) 100% 90% (Folio >> A4) 70% (A4 >> A5) 50% 25% (Min.)

Standard Zoom (Other).

Model	Zoom Level (Original Copy)	Model	Zoom Level (Original Copy)
Inch Models	141% (A5 >> A4) 115% (B5 >> A4) 90% (Folio >> A4) 86% (A4 >> B5) 70% (A4 >> A5)	Metric Models	129% (STMT >> Letter) 115% (B5 >> A4) 86% (A4 >> B5) 78% (Legal >> Letter) 64% (Letter >> STMT)

Zoom Entry

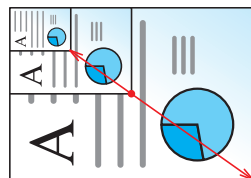

Specify the image size in 1% increment between 25% - 400% of the original.

1 Display the screen.

1 Referring to *Basic Operation on page 4-2*, display the screen.

2

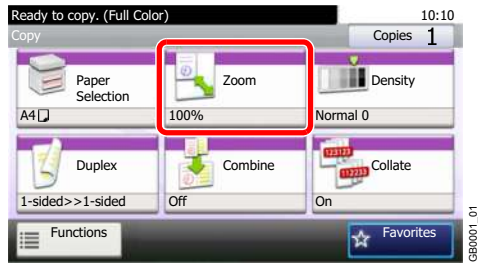

2 Select the function.

[Auto]

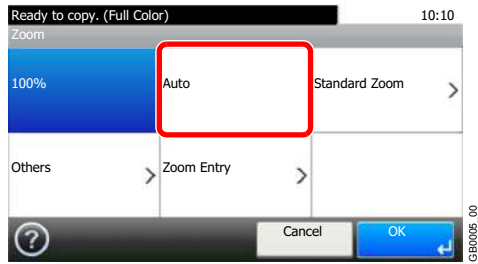

[Standard Zoom], [Other]

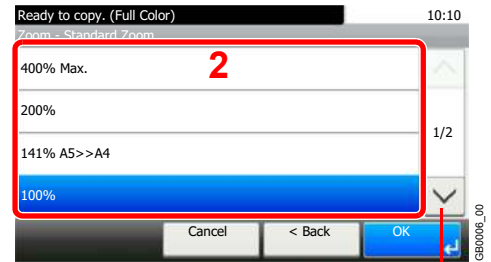
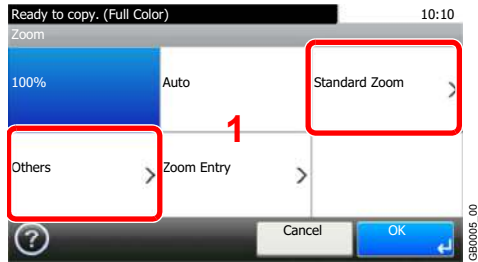

Use [∨] or [^] to scroll up and down.

Select the zoom level.



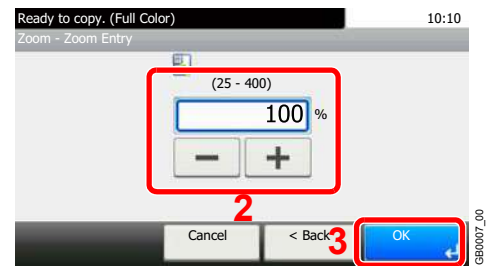
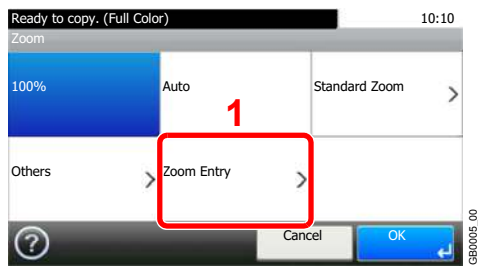

[Zoom Entry]

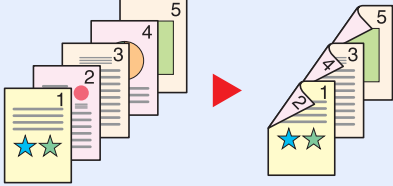

Enter the magnification.

Duplex

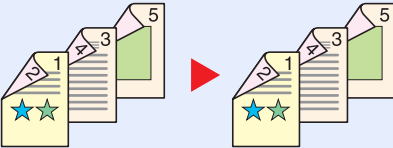
Copy 2-sided documents.

1-sided>>1-sided			Prints 1-sided to 1-sided.	
1-sided>>2-sided			Prints 1-sided to 2-sided.	
2-sided>>1-sided			Prints 2-sided to 1-sided.	
2-sided>>2-sided			Prints 2-sided to 2-sided.	
Others	Duplex	1-sided>>1-sided	Prints 1-sided to 1-sided.	
		1-sided>>2-sided	Prints 1-sided to 2-sided.	
		2-sided>>1-sided	Prints 2-sided to 1-sided.	
		2-sided>>2-sided	Prints 2-sided to 2-sided.	
	Binding in Original*			If you choose a 2-sided sheet original, select the binding edge of the originals.
	Binding in Finishing*			If you choose a 2-sided copy, select the binding edge of the finished copies.
Original Orientation*			Select the orientation of the original document top edge to scan correct direction.	

* This item is not displayed when [1-sided>>1-sided] is selected.



NOTE

The paper sizes supported in Two-sided to Two-sided are Letter, Legal, Executive, Statement, Oficio II, A4, A5, B5, Folio and 216 × 340mm.

1 Display the screen.

- 1 Referring to *Basic Operation* on page 4-2, display the screen.

2

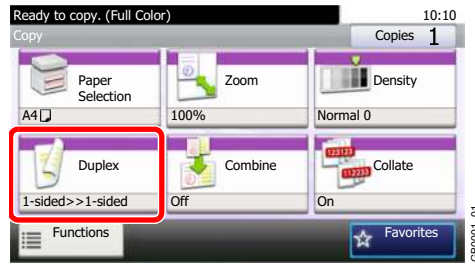

2 Select the function.

[1-sided>>1-sided], [1-sided>>2-sided], [2-sided>>1-sided], or [2-sided>>2-sided]

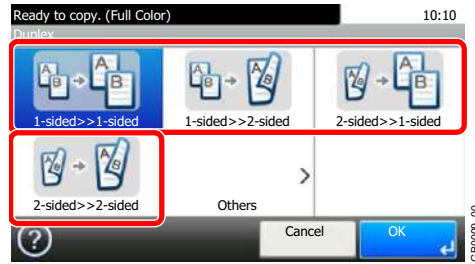

[Others]

1

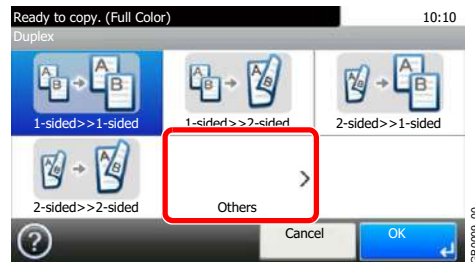

2 Select the desired Duplex option.

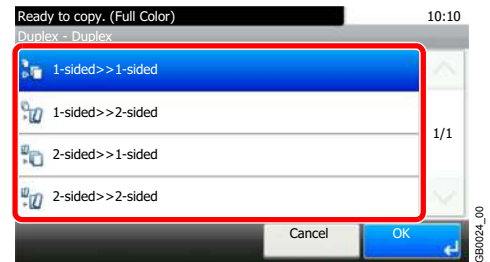
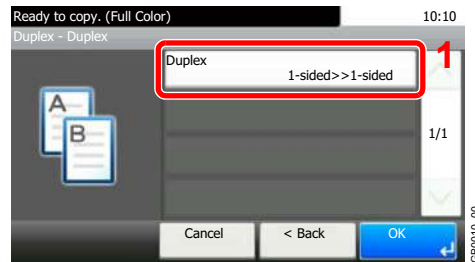

If you choose a 2-sided sheet, proceed to Step 3. If you choose duplex, proceed to Step 4.

3 Select the binding edge of the originals.

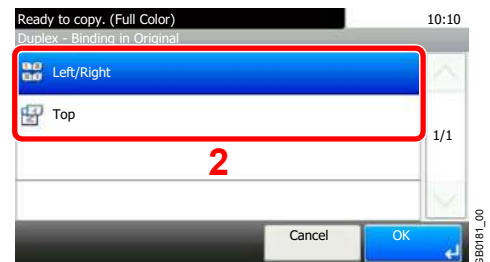
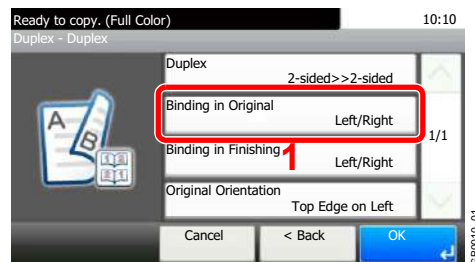

4 Select the binding edge of the finished copies.

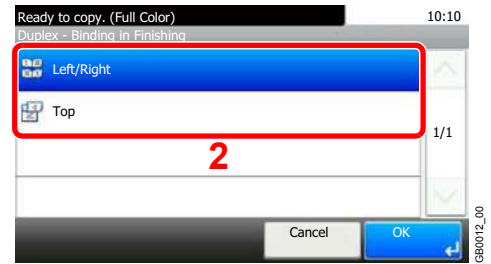
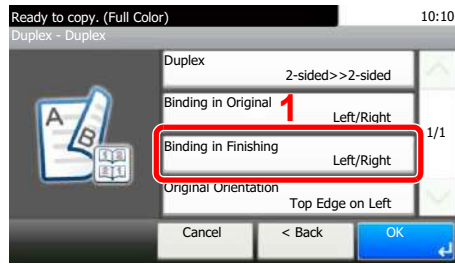

5 Select the original orientation.

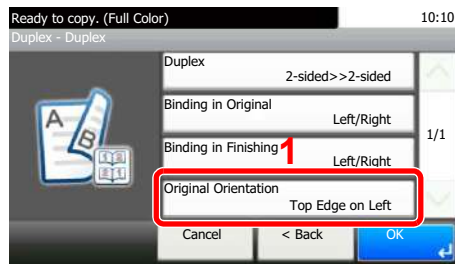

Combine

Combine 2 or 4 original sheets into 1 copied page. You can select the page layout or the type of boundary lines around the pages.

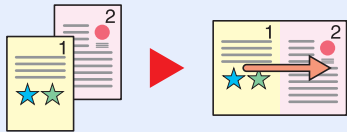
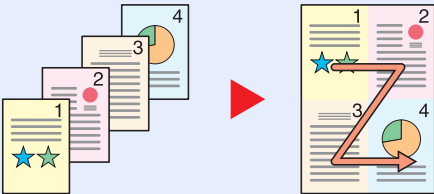
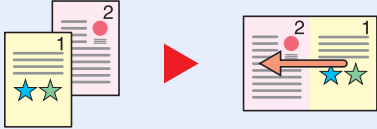
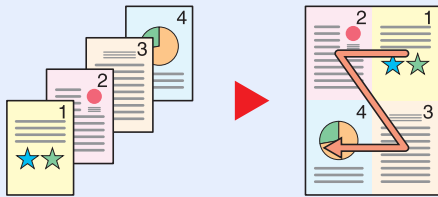
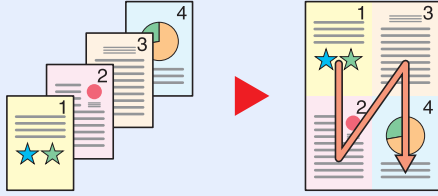
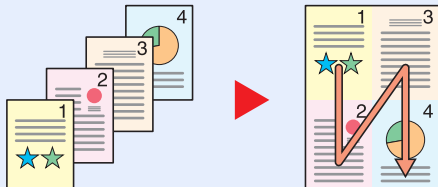
	<p>2 in 1</p> 	<p>Copies 2 originals onto each page.</p>
	<p>4 in 1</p> 	<p>Copies 4 originals onto each page.</p>
<p>Other Settings</p>	<p>Combine</p>	<p>2 in 1 (L to R/T to B)</p>
	<p>2 in 1 (R to L/B to T)</p> 	<p>Copies 2 originals onto each page.</p>
	<p>4 in 1 (Right then Down)</p>	<p>Copies 4 originals onto each page.</p>
	<p>4 in 1 (Left then Down)</p> 	
	<p>4 in 1 (Down then Right)</p> 	
	<p>4 in 1 (Down then Left)</p> 	
<p>Border Line</p>	<p>Sets the boundary line type to a solid line, dotted line, or positioning mark.</p>	
<p>Original Orientation</p>	<p>Select the orientation of the original document top edge to scan correct direction.</p>	



NOTE

Combine mode is available for the copy paper sizes of A4, A5, B5, Folio, Letter, Legal, Statement, Oficio II and 16K. When placing the original on the platen, be sure to copy the originals in page order.

1 Display the screen.

1 Referring to *Basic Operation on page 4-2*, display the screen.

2

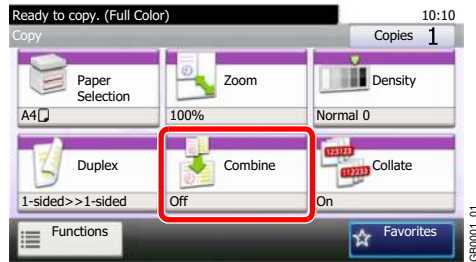

2 Select the function.

[2 in 1] or [4 in 1]

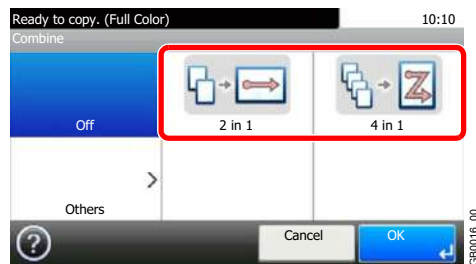

[Others]

1

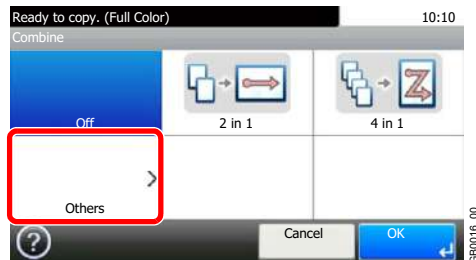

2 Select the desired Combine option.

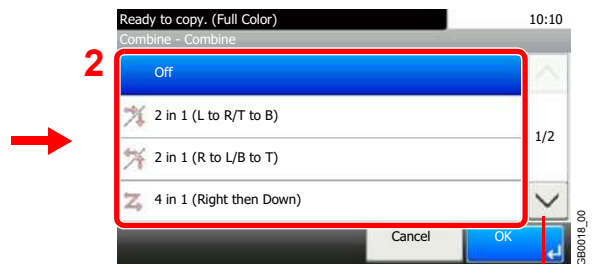

Use [∨] or [∧] to scroll up and down.

3 Sets the boundary line type.

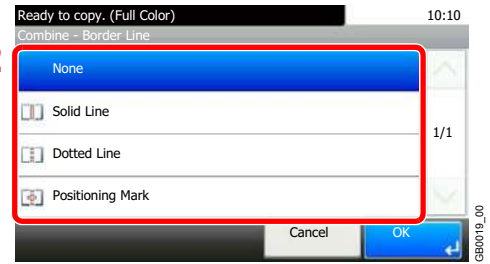
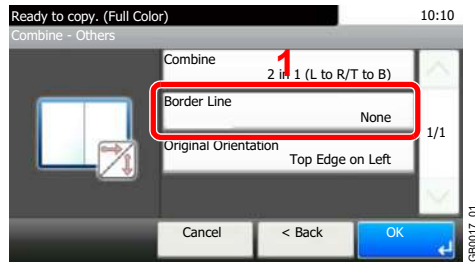

4 Select the original orientation.

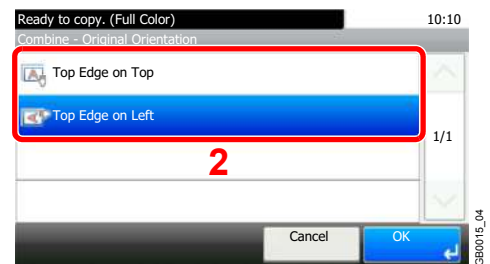
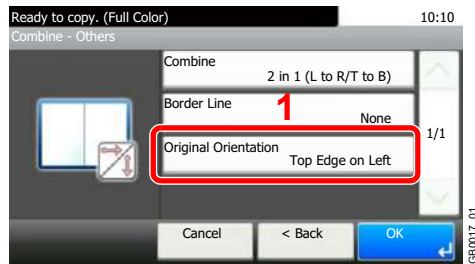

Hue Adjustment

Adjust the color (hue) of images. Make adjustments such as adjusting red to a strong yellow-red or yellow to a strong green-yellow to make more creative copies.

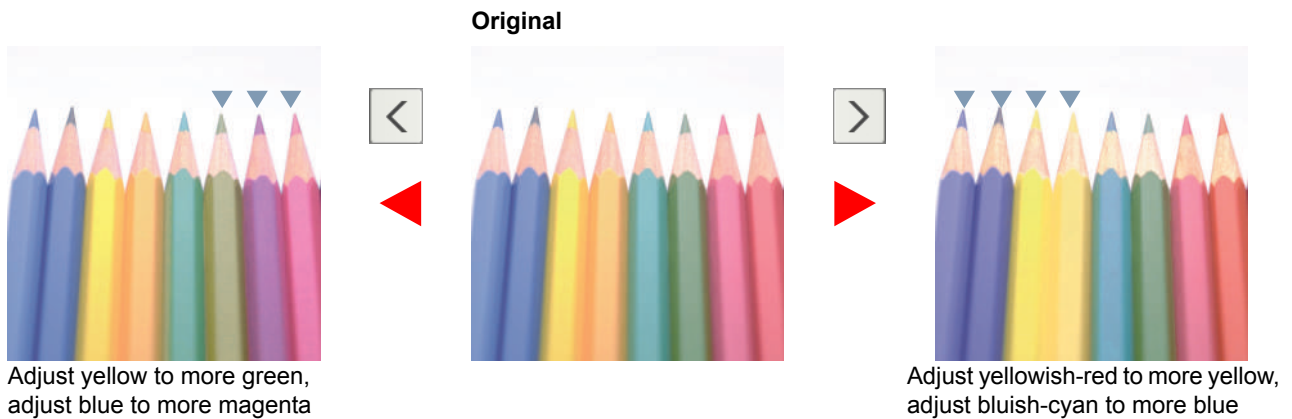

NOTE

This feature is used with full color and auto color copying.
These adjustments are especially useful on rich color images.

1 Display the screen.

1 Referring to *Basic Operation* on page 4-2, display the screen.

2

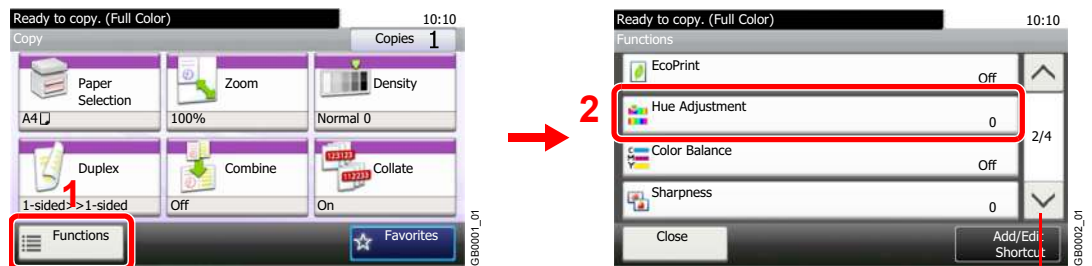

Use [∨] or [∧] to scroll up and down.

2 Select the function.

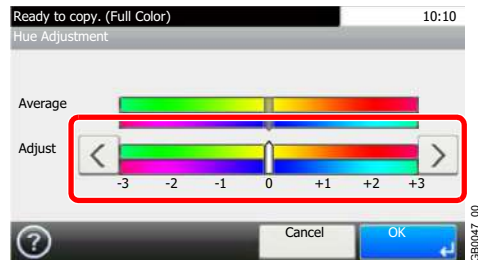

Press [<] or [>] to make the adjustment.

Color Balance

Adjust the strength of cyan, magenta, yellow, and black.

Less Magenta



Original



More Magenta



NOTE

This feature is used with full color and auto color copying.

1 Display the screen.

1 Referring to *Basic Operation on page 4-2*, display the screen.

2

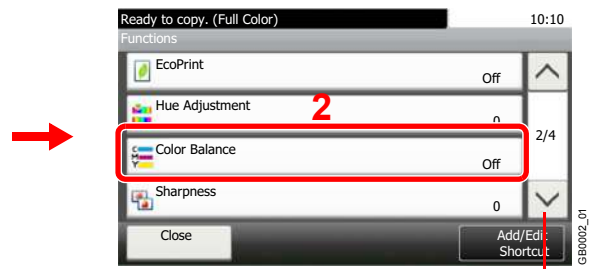
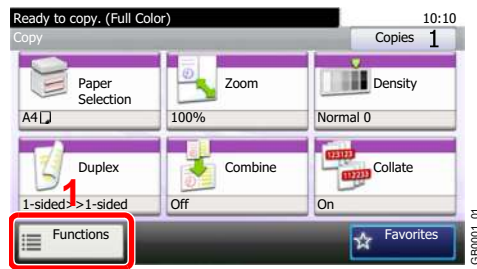

Use [∨] or [∧] to scroll up and down.

2 Select the function.

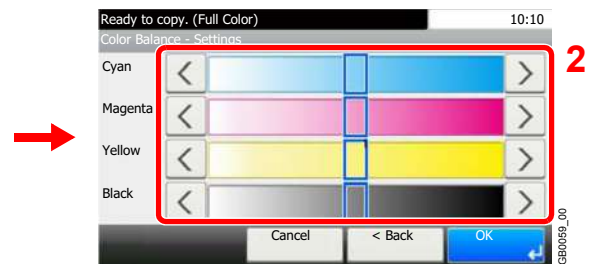
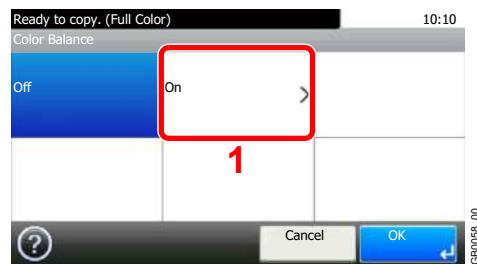

Press [<] or [>] on each side of the color to be adjusted (Cyan, Magenta, Yellow, Black) to adjust each color.

Saturation

Adjust the color saturation of the image.

Grayish



Results in paler color.

Original



Vivid



Results in more vivid color.



NOTE

This feature is used with full color and auto color copying.

1 Display the screen.

1 Referring to *Basic Operation* on page 4-2, display the screen.

2

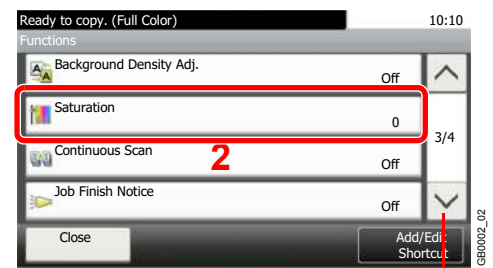
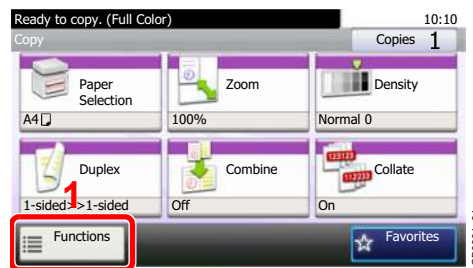

Use [∨] or [∧] to scroll up and down.

2 Select the function.

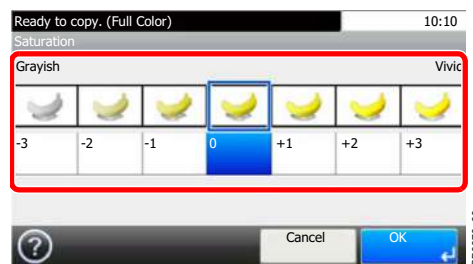

Press [-3] or [+3] (Grayish - Vivid) to adjust the color saturation.

5 Printing

This chapter explains the following topics:

Printing from Applications	5-2
Printing Data Saved on the Printer	5-6
Private Print/Stored Job	5-6
Quick Copy/Proof and Hold	5-8
Automatic Delete Setting for Temporary Documents	5-11

Printing from Applications

This section provides basic instructions for printing documents. Instructions are based on interface elements as they appear in Windows 7.

You can print documents created on your computer once you install the printer driver from the included DVD (Product Library).

 Refer to *Installing Software* on page 2-15.

For more information about how to configure advanced printer driver settings and print documents, refer to the *Printer Driver Operation Guide* on the DVD.

1 Display the window.

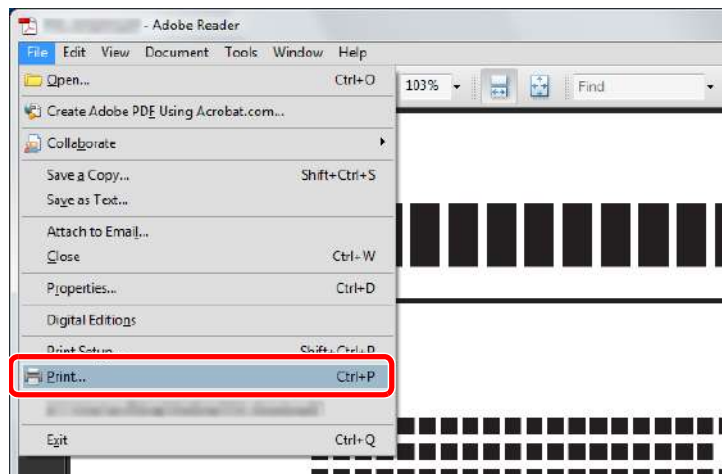

Click **File** and select **Print** in the application.

2 Configure the printer.

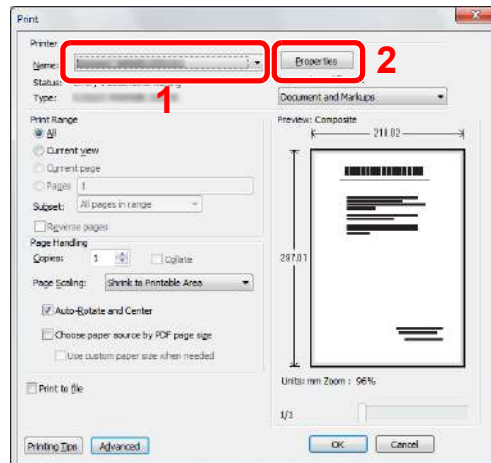

1 Select the printer.

2 Click **Properties** button.

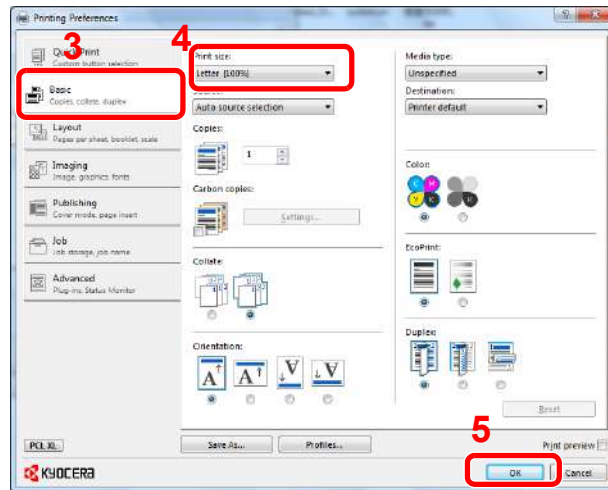

3 Select the **Basic** tab.

4 Click the **Print Size** ▼ button to select the paper size to use for printing from the list.

5 Click **OK** button to return to the **Print** dialog box.

3 Start printing.

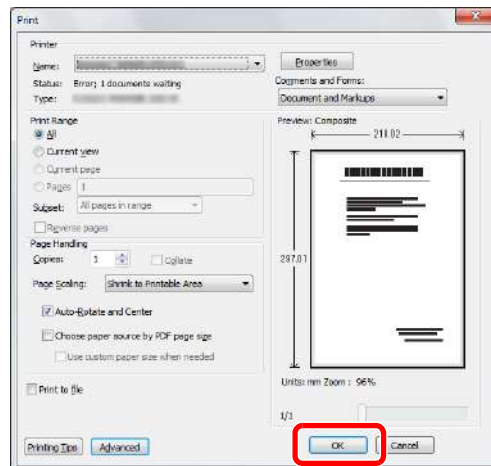

Click **OK** button.



NOTE

Click the tabs on the print settings screen and configure the print settings as necessary. For more information, refer to the *Printer Driver Operation Guide*.

Printer driver print settings screen

The printer driver print settings screen allows you to configure a variety of print-related settings. For more information, refer to the *Printer Driver Operation Guide* on the DVD.

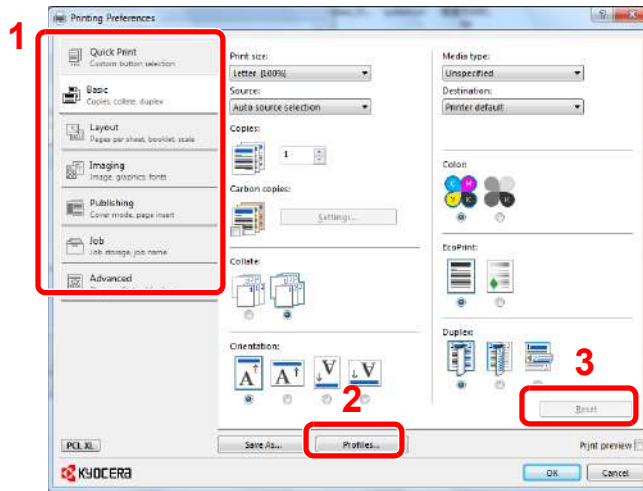

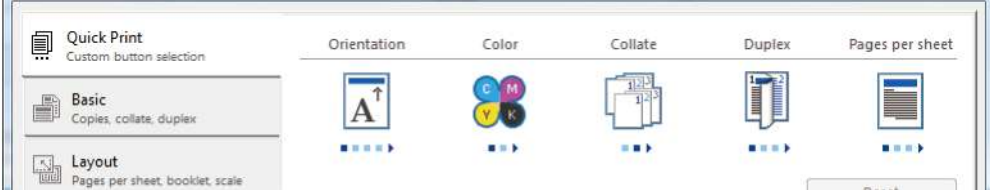
No.	Description
1	<p>Quick Print</p> <p>Provides icons that can be used to easily configure frequently used functions. Each time you click an icon, it changes to an image resembling the print results and applies the settings.</p>  <p>Basic This tab groups basic functions that are frequently used. You can use it to configure the paper size, destination, duplex printing, and color mode.</p> <p>Layout This tab lets you configure settings for printing various layouts, including booklet printing, combine mode, poster printing, and scaling.</p> <p>Imaging This tab lets you configure settings related to the quality and color mode of the print results.</p> <p>Publishing This tab lets you create cover sheets and insert and add OHP film for print jobs.</p> <p>Job This tab lets you configure settings for saving print data from the computer to the machine. Regularly used documents and other data can be saved to the machine for easy printing later. Since saved documents can be printed directly from the machine, this function is also convenient when you wish to print a document that you don't want others to see.</p> <p>Advanced This tab lets you configure settings for adding text pages or watermarks to print data. It also provides simple color adjustment functionality.</p>
2	<p>Profiles</p> <p>Printer driver settings can be saved as a profile. Saved profiles can be recalled at any time, so it's a convenient practice to save frequently used settings.</p>
3	<p>Reset</p> <p>Click to revert settings to their initial values.</p>

Printer Driver Help

The printer driver includes Help. To learn more about print settings, display the printer driver print settings screen and display Help using either of the methods explained below.

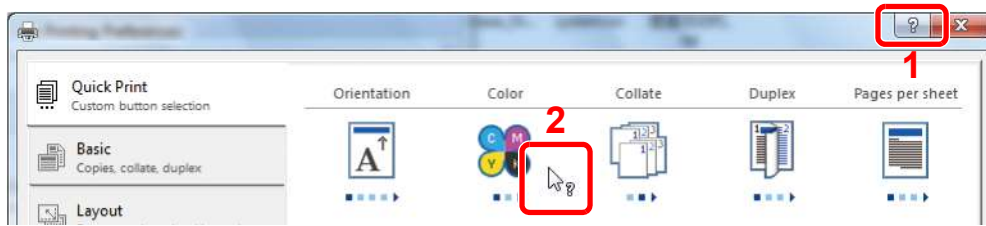

- Click the ? button in the upper right corner of the screen and then click the item you want to know about.
- Click the item you want to know about and press the [F1] key on your keyboard.

Printing Data Saved on the Printer

Print data can be saved in the machine's Job Box and printed when needed.

Private Print/Stored Job

Private Print/Stored Job stores the print data which is printed by using the printer driver as a Private Print/Stored Job. Refer to the *Printer Driver Operation Guide* on how to print a job as Private Print/Stored Job using the printer driver.



NOTE

The optional SSD must be installed or RAM disk mode must be enabled.



For details, refer to *SSD on page 11-4* and *RAM Disk Setting on page 9-26*.

1 Display the screen.

Document Box



1

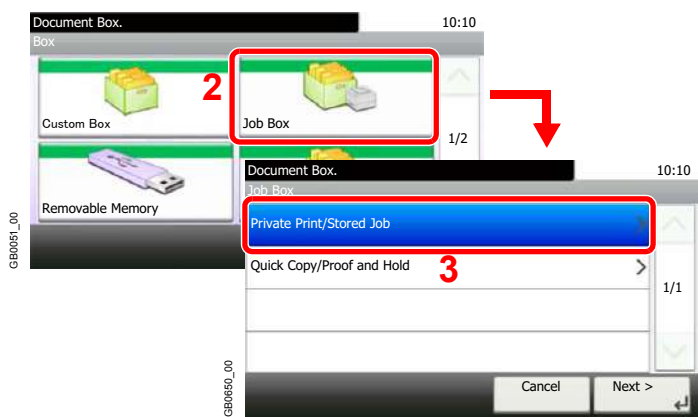

2 Select the creator of the document to print.

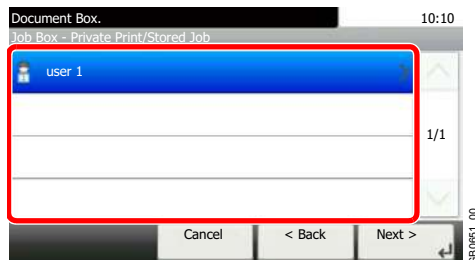

3 Select the document.

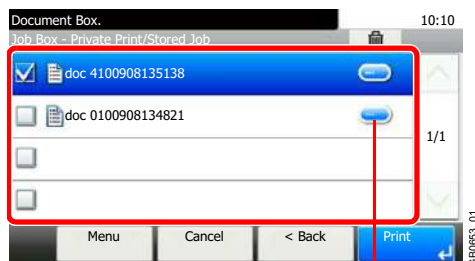

Displays details for individual documents.

4 Print and delete the document.

To print the document

1

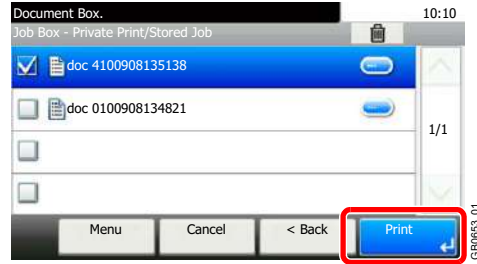

NOTE

The password entry screen will be displayed. Enter the password using the numeric keys.

2

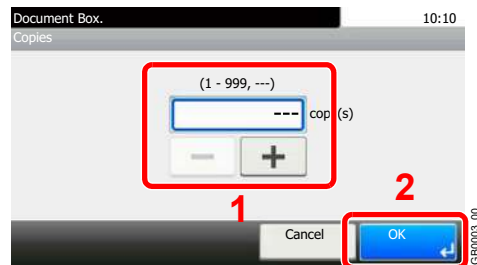

Specify the number of copies to print as desired. When using the number of copies specified with print job, select “---”.

Upon completion of printing, the Private Print job is automatically deleted.

To delete

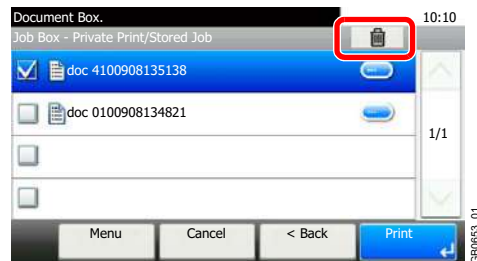

Select the document you wish to delete and press [(Delete)] (the trash can icon).



NOTE

The password entry screen will be displayed. Enter the password using the numeric keys.

Quick Copy/Proof and Hold

Quick Copy/Proof and Hold stores the print data which is printed by using the printer driver as a Quick Copy/Proof and Hold Print job.

Refer to the *Printer Driver Operation Guide* on how to print a job as Quick Copy/Proof and Hold Print job using the printer driver.

NOTE

The optional SSD must be installed or RAM disk mode must be enabled.



For details, refer to *SSD on page 11-4* and *RAM Disk Setting on page 9-26*.

Setting the Number of Stored Jobs

To maintain free space on the RAM disk, you can set the maximum number of stored jobs.

1 Display the screen.

◆ System Menu / Counter

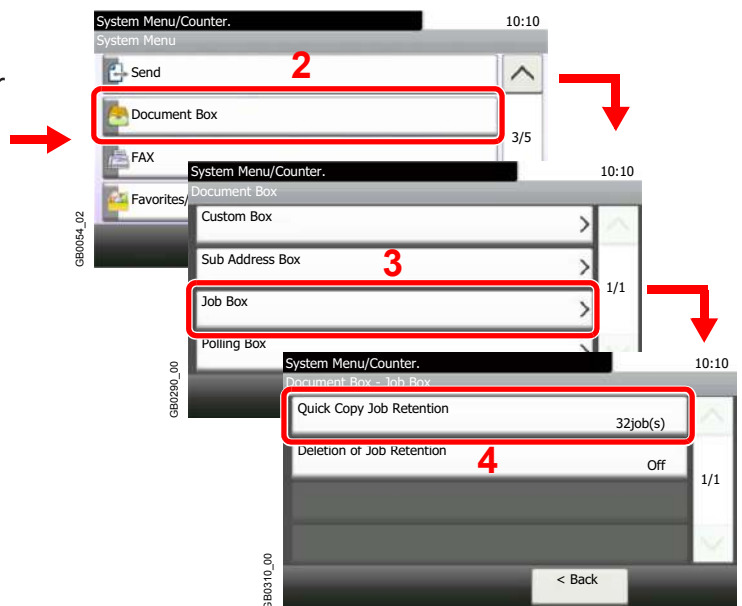

2 Enter the maximum number of stored jobs.

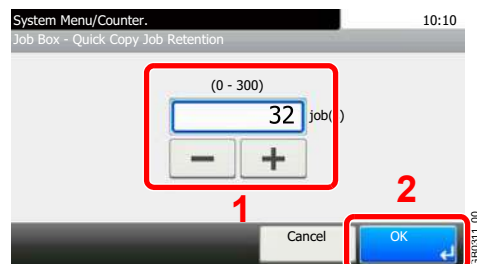

You can enter any number between 0 and 300.

NOTE

If you enter a value of 0 (zero), you cannot use the Quick Copy/Proof and Hold function.

Printing and Deleting the Document

You can print and delete documents stored in the Quick Copy/Proof and Hold box.

1 Display the screen.

Document Box

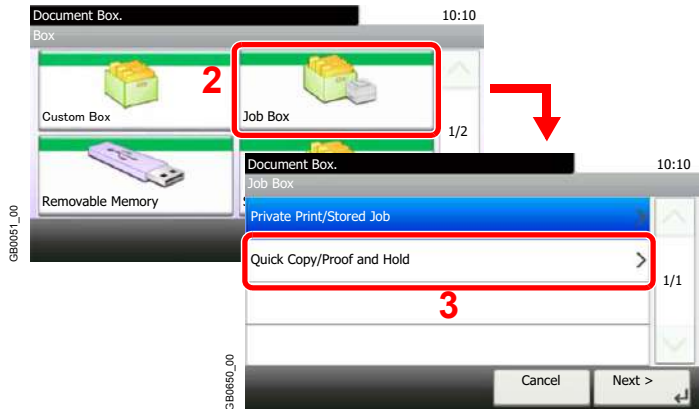

2 Select the creator of the document.

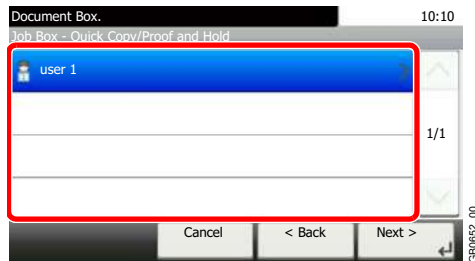

3 Select the document.

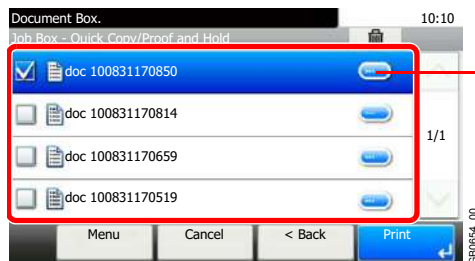

Displays details for individual documents.

4 Print and delete the document.

To print the document

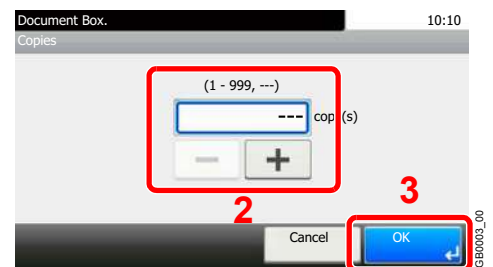
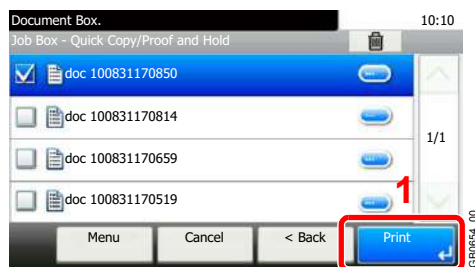

Specify the number of copies to print as desired. When using the number of copies specified with print job, select “---”.

To delete

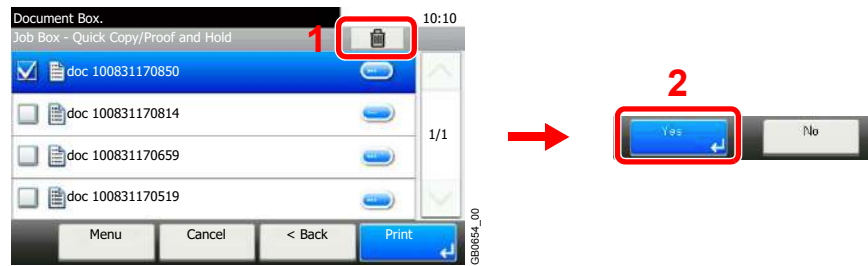

Select the document you wish to delete and press [(Delete)] (the trash can icon).

Automatic Delete Setting for Temporary Documents

This setting specifies that documents, such as Private Printing, or Proof and Hold Printing, saved temporarily in the job box are automatically deleted after they have been saved for a set time.

Off	Temporary documents are not automatically deleted. However, the temporary documents will be deleted when the power is turned off.
1 hour	Documents are deleted after 1 hour.
4 hours	Documents are deleted after 4 hours.
1 day	Documents are deleted after 1 day.
1 week	Documents are deleted after 1 week.

NOTE

This function is valid for documents saved after the function is set.

Regardless of this function setting, temporary documents are deleted when the main power switch is turned off.

1 Display the screen.

◆ System Menu / Counter



1

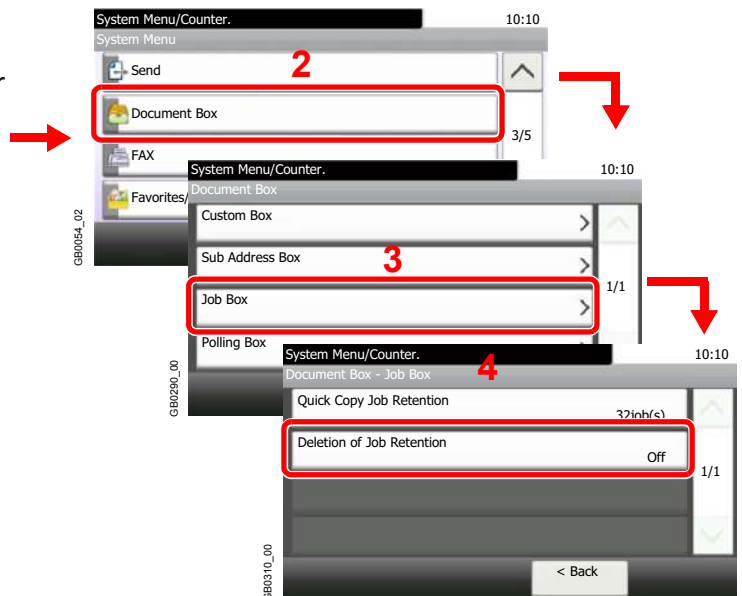

2 Select the time.

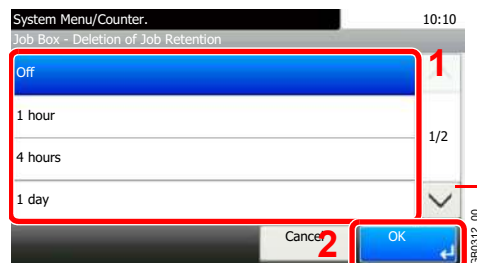

Use [∨] or [∧] to scroll up and down.

6 Sending

This chapter explains the following topics:

Basic Operation	6-2
Preparation for Sending a Document to a PC	6-5
Checking What to Enter for [Host Name]	6-5
Checking What to Enter for [Login User Name]	6-6
Creating a Shared Folder	6-7
Configuring Windows Firewall (for Windows 7)	6-10
Specifying Destination	6-14
Choosing from the Address Book	6-14
Choosing by One Touch Key	6-16
Entering a New E-mail Address	6-17
Specifying a New PC Folder	6-18
Checking and Editing Destinations	6-22
Sending to Different Types of Destinations (Multi Sending)	6-23
Registering Destinations in the Address Book	6-24
Adding a Contact	6-24
Adding a Group	6-28
Editing and Deleting Address Book Entries	6-31
Adding a Destination on One Touch Key	6-33
Adding a Destination	6-33
Editing and Deleting One Touch Key	6-35
Sending Functions	6-36
Sending Size	6-37
File Separation	6-39
E-mail Subject/Body	6-40
FTP Encrypted TX	6-41
WSD Scan	6-42
Scanning using TWAIN	6-45

Basic Operation

This machine can send a scanned image as an attachment to an E-mail message or to a PC linked to the network. In order to do this, it is necessary to register the sender and destination (recipient) address on the network.

A network environment which enables the machine to connect to a mail server is required in order to send e-mail. It is recommended that a Local Area Network (LAN) be used to assist with transmission speed and security issues.

To use the transmission function, verify the following:

- Program the settings, including the E-mail setting on the machine.
- Use Command Center RX (the internal HTML web page) to register the IP address, the host name of the SMTP server, and the recipient.
- Register the destination in the Address Book or One Touch keys.
- Create a share folder in the destination computer, when a folder (SMB/FTP) is selected as the destination. Consult your network administrator concerning destination folder sharing settings.

Basic Sending

Send as E-mail

Sends a scanned original image as an E-mail attachment. (page 6-17)

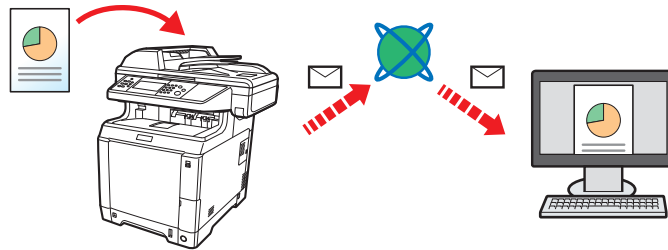

Send to Folder (SMB)

Stores a scanned original image in a shared folder of any PC. (page 6-18)

Send to Folder (FTP)

Stores a scanned original image in a folder of an FTP server. (page 6-18)

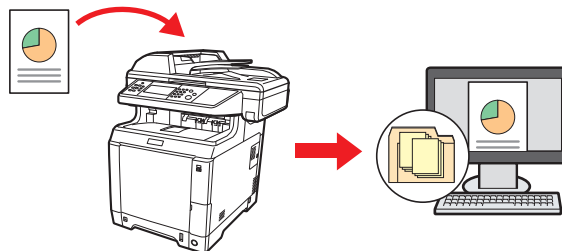



Image Data Scanning with TWAIN/WIA

Scan the document using a TWAIN or WIA compatible application program. (page 6-45)

 **NOTE**
Different sending options can be specified in combination. Refer to *Sending to Different Types of Destinations (Multi Sending)* on page 6-23.
This function can only be used on products equipped with fax capability. For details about this function, refer to the *FAX Operation Guide*.

1 Press the Send key

Send



NOTE

If the touch panel is turned off, press the **Energy Saver** key and wait for the machine to warm up.

2 Place the originals

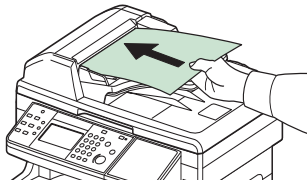
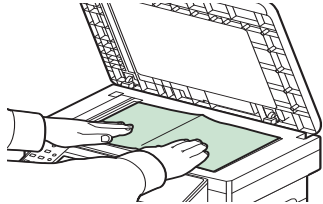

For details, refer to *Loading Originals* on page 3-10.

3 Selecting color mode

 Auto Color



 Full Color



Black & White



Auto Color	Automatically recognizes whether a document is color or black & white and then scans the document.
Full Color	Scans all documents in full color.
Black & White	Scans all documents in black & white.



To make more detailed settings, refer to *Color Selection* on page 3-53.

4 Specifying destination



Select the destination to which to send an image.



For details, refer to *Specifying Destination* on page 6-14.

5 Selecting the functions

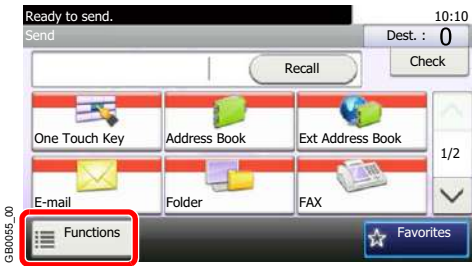

Press [Functions] to display the sending functions to use.

For details, refer to *Sending Functions* on page 6-36.

6 Start sending

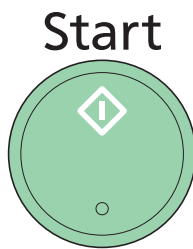

Press the **Start** key to start sending.

Preparation for Sending a Document to a PC

Check the information that needs to be set on the machine and create a folder to receive the document on your computer. Screens of Windows 7 are used in the following explanation. The details of the screens will vary in other versions of Windows.



NOTE

Log on to Windows with administrator privileges.

Checking What to Enter for [Host Name]

Check the name of the destination computer.

1 Display the window.

From the Start menu, select **Computer** and then **System Properties**.

In Windows XP, right-click **My Computer** and select **Properties**. The **System Properties** dialog box appears. Click the **Computer Name** tab in the window that appears.

In Windows 8, select the desktop in the Start screen, right-click **Computer** from **Libraries**, and then select **Properties**.

2 Check the computer name.

Check the computer name in the window that appears.

If there is a workgroup



All characters appearing in "Full computer name" should be entered in [Host Name]. (Example: PC001)

If there is a domain



The characters to the left of the first dot (.) in "Full computer name" should be entered in [Host Name]. (Example: pc001)

After checking the computer name, click the  (Close) button to close the **System Properties** screen.

In Windows XP, after checking the computer name, click the **Cancel** button to close the **System Properties** screen.

Checking What to Enter for [Login User Name]

Check the domain name and user name for logging onto Windows.

1 Display the window.

From the Start menu, select **All Programs** (or **Programs**), **Accessories** and then **Command Prompt**.

In Windows 8, display **Apps** on **Search** in charms on the Start screen, and select **Command Prompt**.

The **Command Prompt** window appears.

2 Check the domain name and user name.

At the Command Prompt, enter "net config workstation" and then press [Enter].

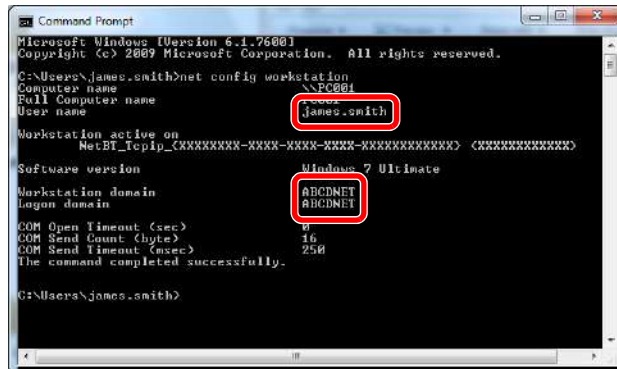

```
Microsoft Windows [Version 6.1.7600]
Copyright (c) 2009 Microsoft Corporation. All rights reserved.

C:\Users\james.smith>net config workstation
Computer name                \PC001
Full Computer name          james.smith
User name                    james.smith
Workstation active on
NetBI_Tcpip_XXXXXXXX-XXXX-XXXX-XXXXXXXXXXXXXXXX <XXXXXXXXXXXX>
Software version            Windows 7 Ultimate
Workstation domain          ABCDNET
Logon domain                 ABCDNET
COM Open Timeout (sec)     0
COM Send Count (byte)      16
COM Send Timeout (sec)     250
The command completed successfully.

C:\Users\james.smith>
```

Screen example: user name "james.smith" and domain name "ABCDNET"

Creating a Shared Folder

Create a shared folder to receive the document in the destination computer.

NOTE

If there is a workgroup in System Properties, configure the settings below to limit folder access to a specific user or group.

- 1 From the Start menu, select **Control Panel, Appearance and Personalization**, and then **Folder Options**.

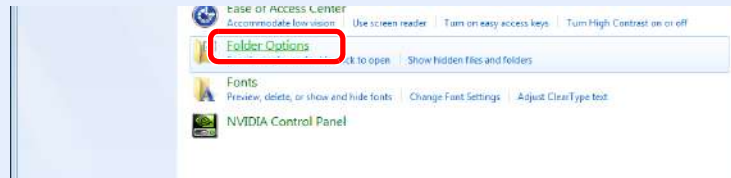

Windows XP, click **My Computer** and select **Folder Options** in **Tools**.

In Windows 8, select **Settings** in charms on Desktop, and select **Control Panel, Appearance and Personalization**, and then **Folder Options**.

2

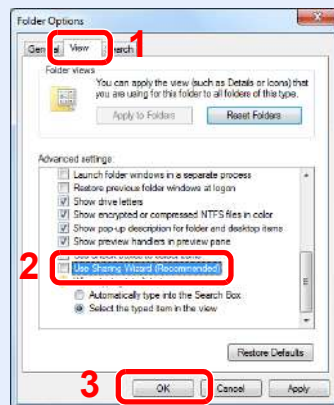

Remove the checkmark from **Use Sharing Wizard (Recommended)** in **Advanced settings**.

In Windows XP, click the **View** tab and remove the checkmark from **Use Simple File Sharing (Recommended)** in **Advanced settings**.

1 Create a folder.

- 1 Create a folder on the local disk (C).

For example, create a folder with the name "scannerdata" on the local disk (C).

- 2 Right-click the scannerdata folder and click **Share** and **Advanced** sharing. Click the **Advanced Sharing** button.

In Windows XP, right-click the scannerdata folder and select **Sharing and Security...** (or **Sharing**).

2 Configures permission settings.

1

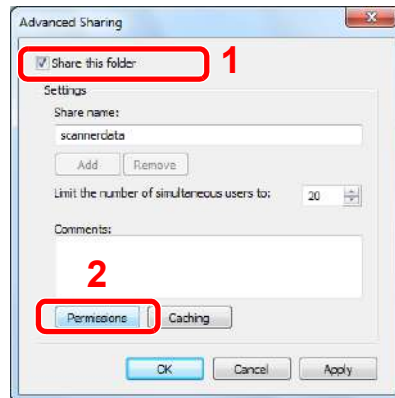

In Windows XP, select **Share this folder** and click the **Permissions** button.

2

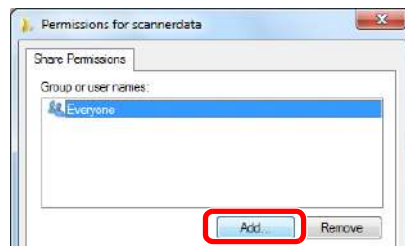

3

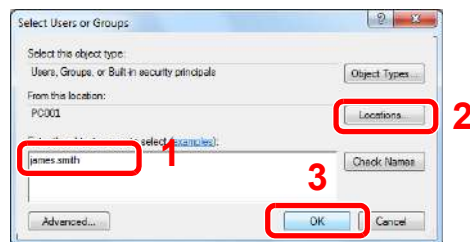

Enter the user name in the text box.

Click the [Location] button and select the desired location. To select the search target, click a location to select it. When you are a member of a domain, your current domain will be set as the search target by default.

4

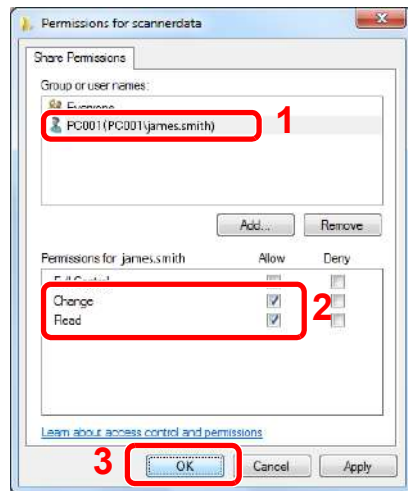

Select the entered user, select the **Change** and **Read** permissions.

In Windows XP, go to step **6**.



NOTE

"Everyone" gives sharing permission to everyone on the network. To strengthen security, it is recommended that you select Everyone and remove the **Read** permission checkmark.

5 Click the **OK** button in the **Advanced Sharing** screen to close the screen.

6

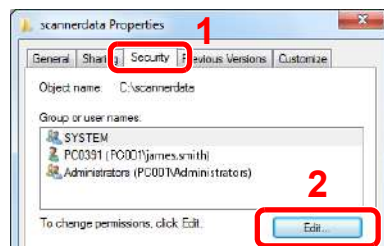

In Windows XP, click the **Security** tab and then click the **Add** button.

7 Proceed in the same way as in step **3** to add a user to **Group or user names**.

8

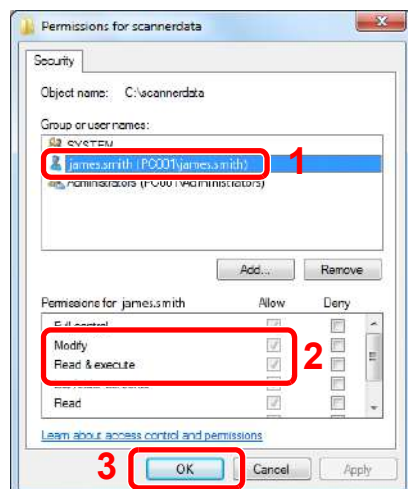

Select the added user, select the **Modify** and **Read & execute** permissions.

Configuring Windows Firewall (for Windows 7)

Permit sharing of files and printers and set the port used for SMB transmission.



NOTE

Log on to Windows with administrator privileges.

1 Check file and printer sharing.

- 1 From the Start menu, select **Control Panel**, **System and Security**, and **Allow a program through Windows Firewall**.

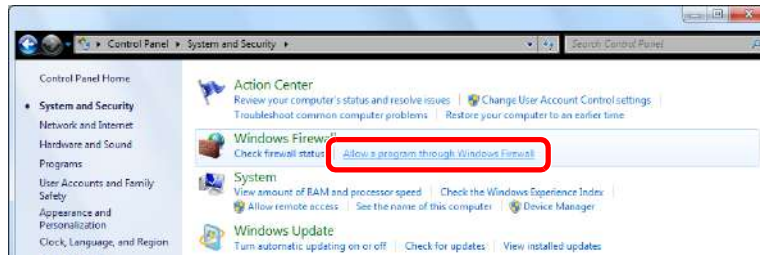

NOTE

If the **User Account Control** dialog box appears, click the **Continue** button.

2

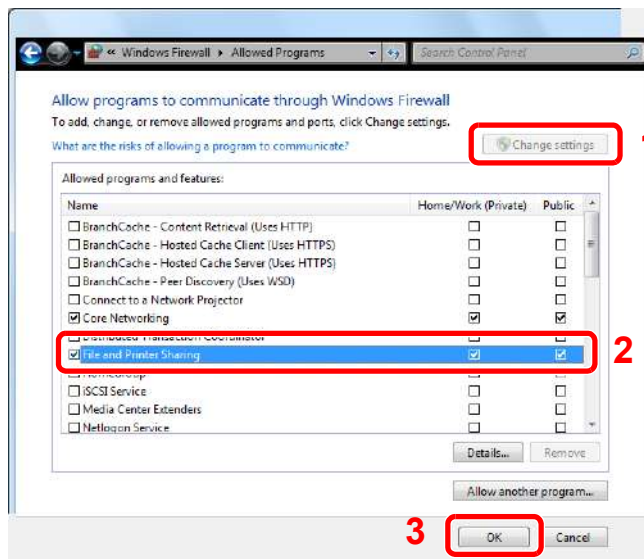

Select the **File and Printer Sharing** checkbox.

2 Add a port.

- 1 From the Start menu, select **Control Panel**, **System and Security**, and **Check firewall status**.

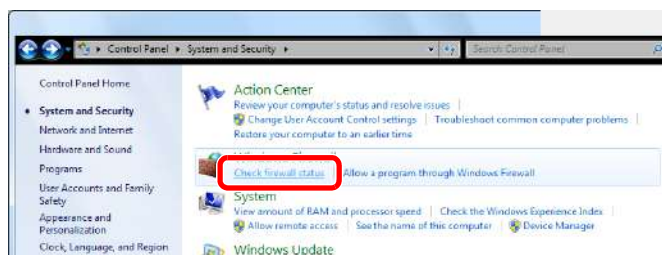

2



3



4

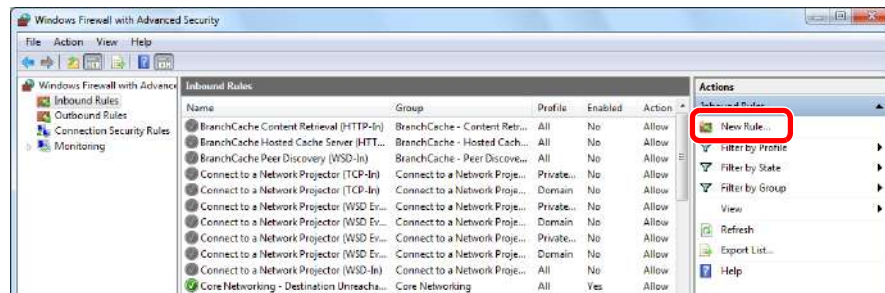

5

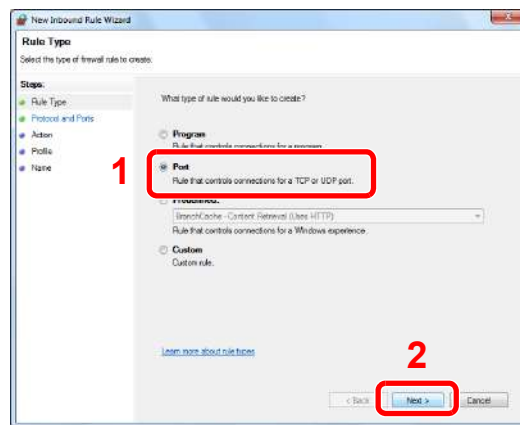

6

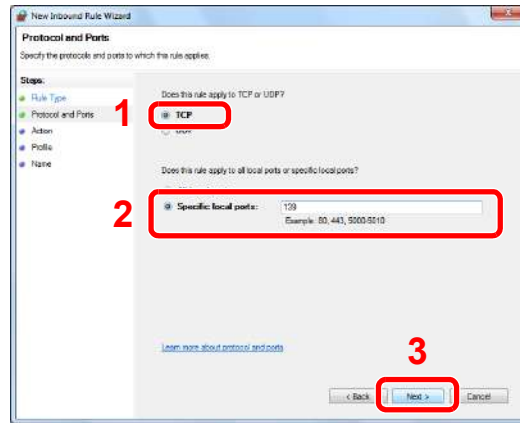

Select **Specific local ports**, and enter "139".

7

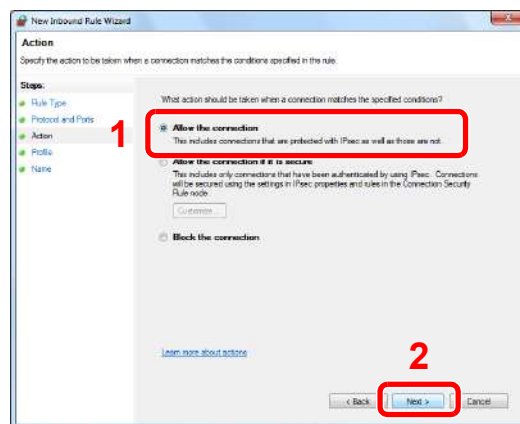

8

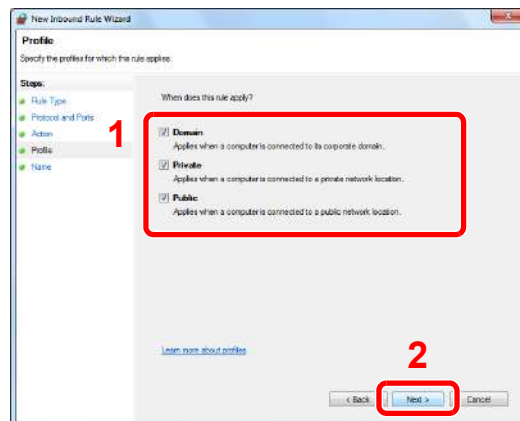

Make sure all checkboxes are selected.

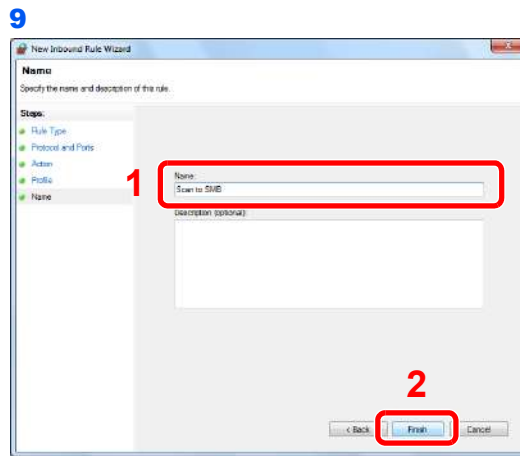

Enter "Scan to SMB" in "Name" and click **Finish**.

In Windows XP or Windows Vista

- 1 In Windows XP, from **Start** button on the Windows, select **Control Panel**, and then **Windows Firewall**.
In Windows Vista, from **Start** button on the Windows, select **Control Panel**, **Security**, and then **Turn Windows Firewall on or off**.
If the User Account Control dialog box appears, click the **Continue** button.
- 2 Click the **Exceptions** tab and then the **Add port...** button.
- 3 Specify **Add a Port** settings.
Enter any name in "Name" (example: Scan to SMB). This will be the name of the new port.
Enter "139" in "Port Number". Select **TCP** for "Protocol".
- 4 Click the **OK** button to close the **Add a Port** dialog box.

In Windows 8

- 1 In charms on Desktop, click **Settings**, **Control Panel**, **System and Security**, and then **Windows Firewall**.
If the User Account Control dialog box appears, click the **Continue** button.
- 2 Configure the settings, refer to *Configuring Windows Firewall (for Windows 7)* on page 6-10.

Specifying Destination

Select the destination to which to send an image.

Select the destination using either of the following methods.

- *Choosing from the Address Book* (page 6-14)
- *Choosing by One Touch Key* (page 6-16)
- *Entering a New E-mail Address* (page 6-17)
- *Specifying a New PC Folder* (page 6-18)

 **NOTE**

If you are using the products equipped with the fax function, you can specify the fax destination. Enter the other party's number using the numeric keypad.

Choosing from the Address Book

Select a destination registered in the Address Book.

 **NOTE**

For more information about how to register destinations in the Address Book, refer to *Registering Destinations in the Address Book* on page 6-24.

For details on the External Address Book, refer to *Command Center RX User Guide*.

1 Display the screen.

- 1 Referring to *Basic Operation* on page 6-2, display the screen.

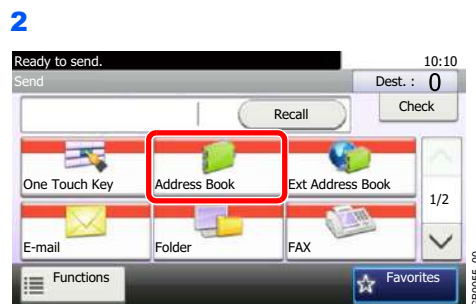

2 Select the destination.



Use [∨] or [∧] to scroll up and down.

Press the checkbox to select the desired destination from the list. The selected destinations are indicated by a checkmark in the check box.

Destination Search

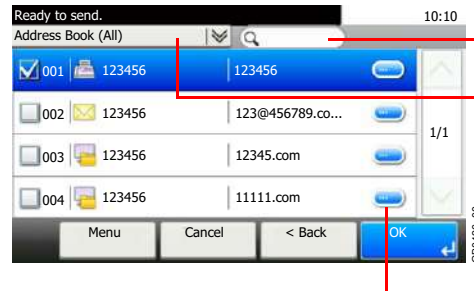

Searches by destination name.

Advanced search by type of registered destination (E-mail, Folder (SMB/FTP), FAX or Group).

Displays details for individual destinations.

You can specify a destination by address number by pressing the **Quick No. Search** key.

You can also press [Menu] to perform a more detailed search.

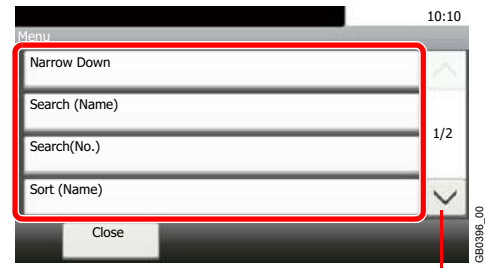
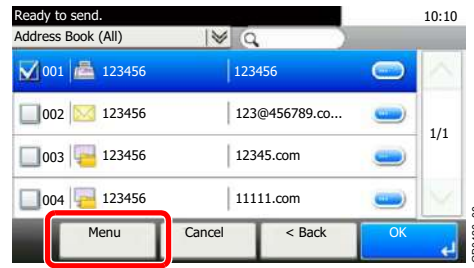

Use [∨] or [∧] to scroll up and down.

Narrow Down: Advanced search by type of registered destination (E-mail, Folder (SMB/FTP), FAX or Group).

Search (Name) and Search (No.): Searches by destination name or address number.

Sort (Name) and Sort (No.): Sorts the list by destination name or address number.



NOTE

You may choose multiple destinations.

To cancel a selection, press the corresponding checkbox to clear the check mark.

3 Accept the destinations.

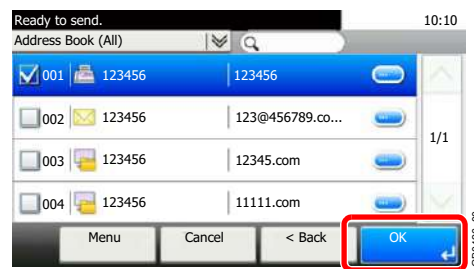

Destinations can be changed later. Refer to *Checking and Editing Destinations* on page 6-22.

Choosing by One Touch Key

Select the destination using the One Touch Keys.

NOTE

For more information on adding One Touch keys, refer to *Adding a Destination on One Touch Key on page 6-33*.

1 Display the screen.

1 Referring to *Basic Operation on page 6-2*, display the screen.

2



2 Select the destination.

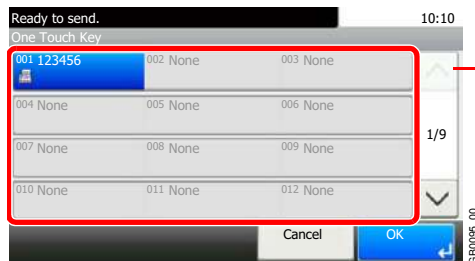

Use [∨] or [∧] to scroll up and down.

Press the One Touch Keys where the destination is registered. Multiple One Touch Keys can be selected.

You can specify a one-touch key by one-touch number by pressing the **Quick No. Search** key.

3 Accept the destination.

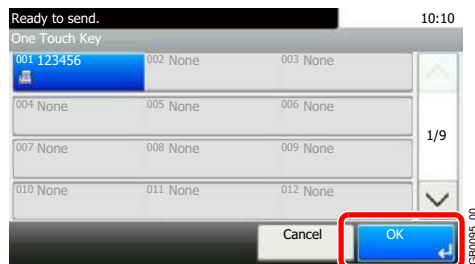

Destinations can be changed later. Refer to *Checking and Editing Destinations on page 6-22*.

Entering a New E-mail Address

Enter the desired e-mail address.

 **NOTE**
 Access the Command Center RX beforehand and specify the settings required for sending e-mail. For details, refer to *E-mail settings on page 2-34*.

1 Display the screen.

1 Referring to *Basic Operation on page 6-2*, display the screen.



2 Enter destination E-mail address.

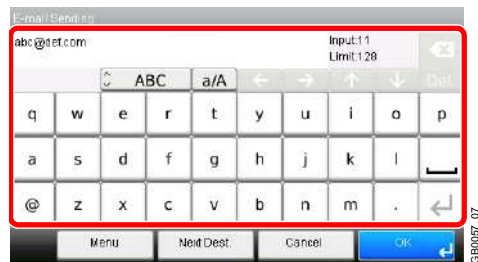

Up to 128 characters can be entered.

 Refer to *Character Entry Method on page 11-8* for details on entering characters.

To enter multiple destinations, press [Next Destination] and enter the next destination. Up to 100 E-mail addresses can be specified.

You can register the entered email address in the Address Book by pressing [Menu] and then [Add to Address Book]. You can also replace the information for a previously registered destination.

3 Accept the destinations.



 Destinations can be changed later. Refer to *Checking and Editing Destinations on page 6-22*.

Specifying a New PC Folder

Specify either the desired shared folder on a computer or an FTP server as the destination.

NOTE

Refer to *Creating a Shared Folder on page 6-7* for details on how to share a folder.

Be sure that **SMB Protocol** or **FTP** in the Command Center RX is On. For details, refer to the *Command Center RX User Guide*.

1 Display the screen.

1 Referring to *Basic Operation on page 6-2*, display the screen.

2



2 Select the folder type.

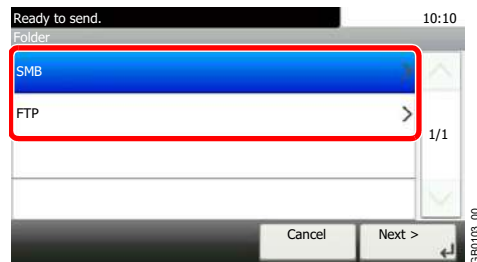

If you selected [FTP], go to step 4.

3 Select the folder specification method.

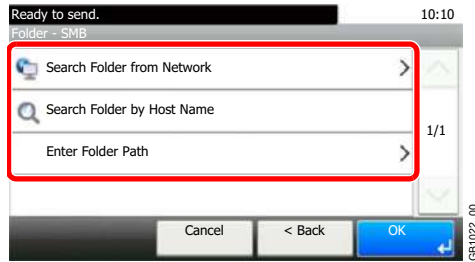

To search for a folder on a PC on the network, press [Search Folder from Network] or [Search Folder by Host Name].

If you pressed [Search Folder from Network], you can enter the *Domain/Workgroup*, and *Host Name* to search PCs on the network for the destination.

If you pressed [Search Folder by Host Name], you can search all PCs on the network for a destination.

A maximum of 500 addresses can be displayed. Select the host name (PC name) that you want to specify in the screen that appears, and press [Next]. The login user name and login password entry screen appears.

After you enter the login user name and login password name of the destination PC, the shared folders appear. Select the folder that you want to specify and press [Next]. The address of the selected shared folder is set.



NOTE

Refer to the *Character Entry Method* on page 11-8 for details on entering characters.

Press [Connection Test] to check the connection to the computer you chose. If the connection fails, check the entries you made.

Select the folder from the Search Results list, and go to step 6.

If you selected [Enter Folder Path], go to step 4.

4 Enter the destination information.

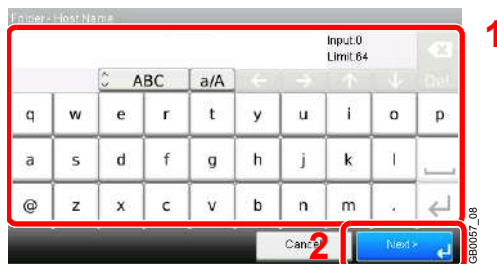

Enter the next information. Once you have entered one item, press [Next] to advance to the next item.

For send to folder (SMB)

Item	Data to be entered	Max. characters
Host Name	Host name or IP address of the PC to receive the data.	Up to 64 characters
Path	Share name For example: scannerdata If saving in a folder in the shared folder: "share name\folder name in shared folder"	Up to 128 characters
Port	Normally 139. In Windows Vista/7, if 139 is not used, set to 445.	1 - 65535
Login User Name	User name to access the PC Domain name\User name For example, <i>abcdnet\james.smith</i> . User name@Domain name For example, <i>james.smith@abcdnet</i>	Up to 64 characters
Login Password	Password to access the PC	Up to 64 characters

For send to folder (FTP)

Item	Data to be entered	Max. characters
Host Name	Host name or IP address of FTP server	Up to 64 characters
Path	Path for the file to be stored For example, "User\ScanData". If no path is entered, the file is stored in the home directory.	Up to 128 characters
Login User Name	FTP server login user name	Up to 64 characters
Login Password	FTP server login password	Up to 64 characters

 Refer to *Character Entry Method* on page 11-8 for details on entering characters.

5 Confirm the information.

Check the information. Change the information as needed by pressing the item in question.

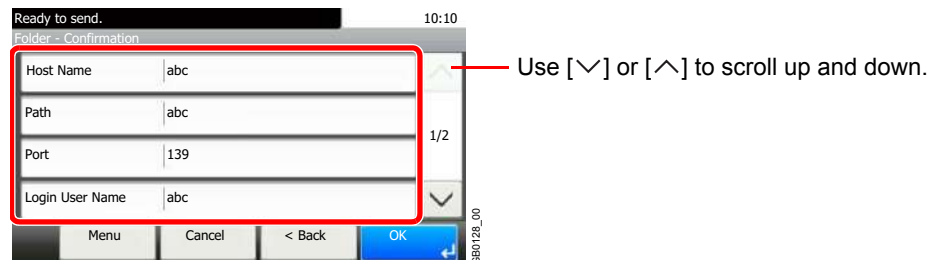

When specifying a computer or server port number as the destination, press [Port] and enter the port number. You can enter a number from 1 to 65,535 with a maximum of 5 digits.

Confirm the connection status.

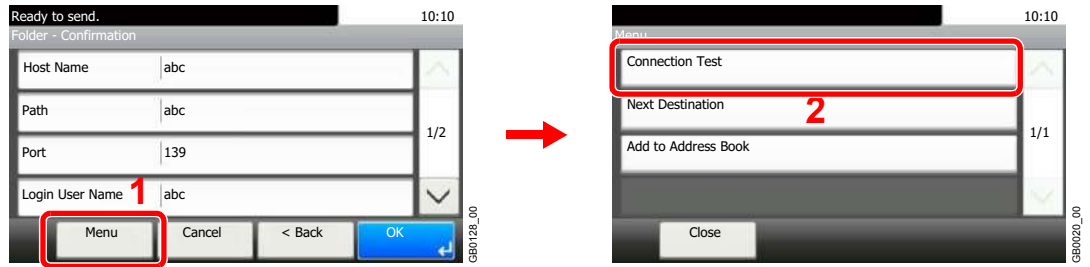



Connected. appears when connection to the destination is correctly established. If *Cannot connect.* appears, review the entry.

To enter multiple destinations, press [Next Destination] and enter the next destination. You can specify a combined total of up to 5 FTP and SMB destination folders.

You can register the entered information in the Address Book by pressing [Menu] and then [Add to Address Book].

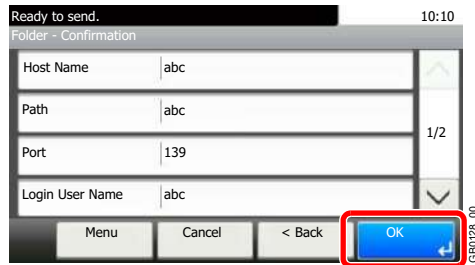
6 Accept the destinations.



 Destinations can be changed later. Refer to *Checking and Editing Destinations* on page 6-22.

Checking and Editing Destinations

Check and edit a selected destination.

1 Display the screen.

1 Referring to *Specifying Destination on page 6-14*, specify the destination.

2

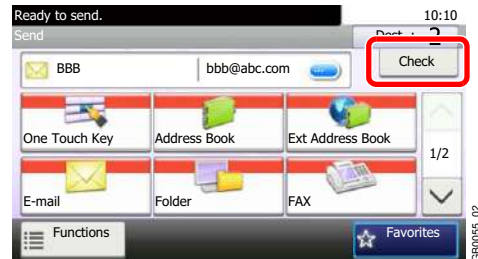

2 Check and edit the destination.

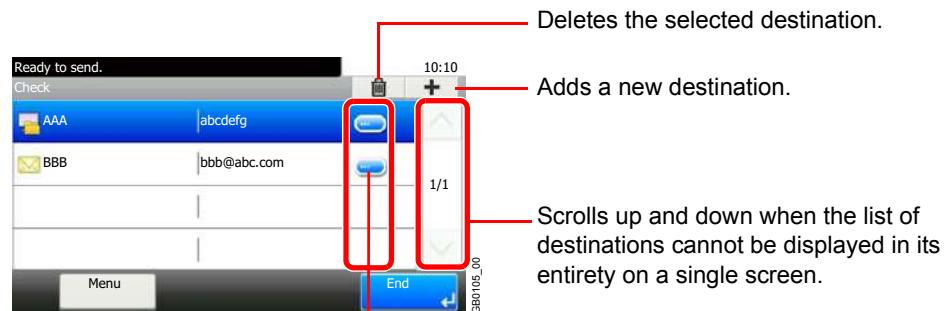

Displays details for the destinations. New E-mail addresses and PC folders can be edited if they have been specified.

Sending to Different Types of Destinations (Multi Sending)

You can specify destinations that combine e-mail addresses, folders (SMB or FTP) and fax numbers*. This is referred to as *Multi Sending*. This is useful for sending to different types of destination (e-mail addresses, folders, etc.) in a single operation.

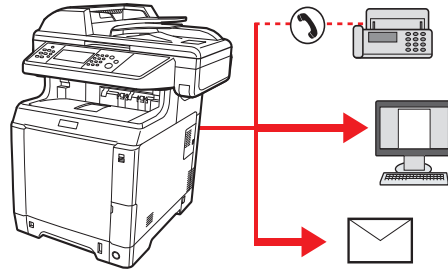

* Fax functionality can only be used on products equipped with fax capability.

No. of broadcast items

E-mail: Up to 100

Folders (SMB, FTP): Total of 5 SMB and FTP

FAX: Up to 100

Procedures are the same as used in specifying the destinations of respective types. Continue to enter E-mail address or folder path so that they appear in the destination list. Press the **Start** key to launch transmission to all destinations at one time.



NOTE

If the destinations include a fax, the images sent to all destinations will be black and white.

Registering Destinations in the Address Book

Add a new destination to the Address Book. There are two registering methods, contacts and groups. When adding a group, enter the group name and select group members from the Address Book.

Adding a Contact

A maximum of 200 contact addresses can be registered. Each address can include the information such as destination name, E-mail address, FTP server folder path, computer folder path, and FAX No. (Only on products with the fax function installed).

NOTE

If user login administration is enabled, you can only edit destinations in the Address Book by logging in with administrator privileges.

Contact addresses can also be registered in the system menu.

1 Display the screen.

Send

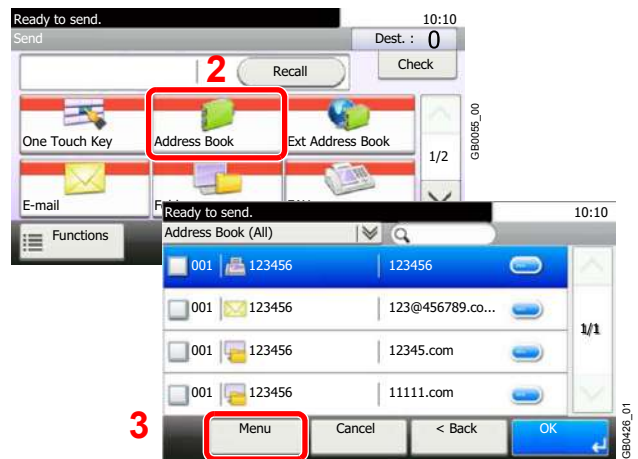

2 Adds a new destination.

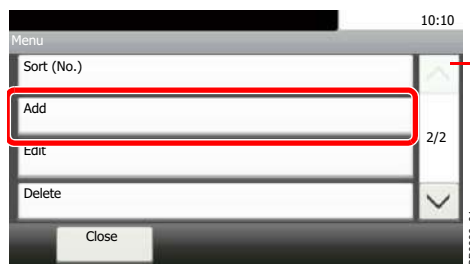

Use [v] or [^] to scroll up and down.

3 Select the registration method.

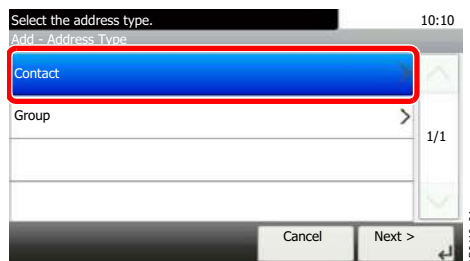

4 Enter the destination name.



Up to 32 characters can be entered.

Refer to *Character Entry Method* on page 11-8 for details on entering characters.

5 Enter the destination.

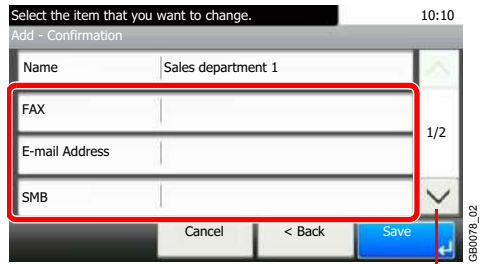

Use [∨] or [∧] to scroll up and down.

Select the type of destination to register.

For details on FAX, refer to *FAX Operation Guide*.

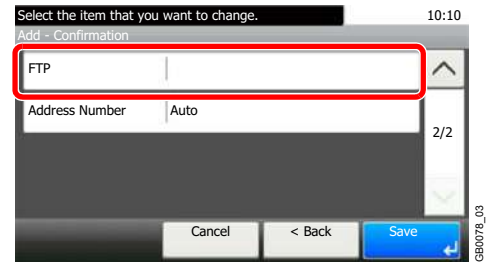

E-mail Address



Enter the E-mail address. Up to 128 characters can be entered.

Refer to *Character Entry Method* on page 11-8 for details on entering characters.

The Folder (SMB) Address

1 Enter *Host Name*, *Path*, *Port*, *Login User Name* and *Login Password*.

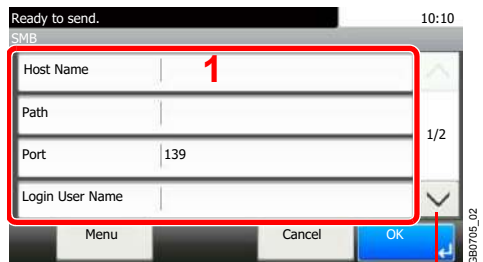

Use [∨] or [∧] to scroll up and down.



For more information, refer to *Specifying a New PC Folder* on page 6-18.

2 Confirm the connection status.

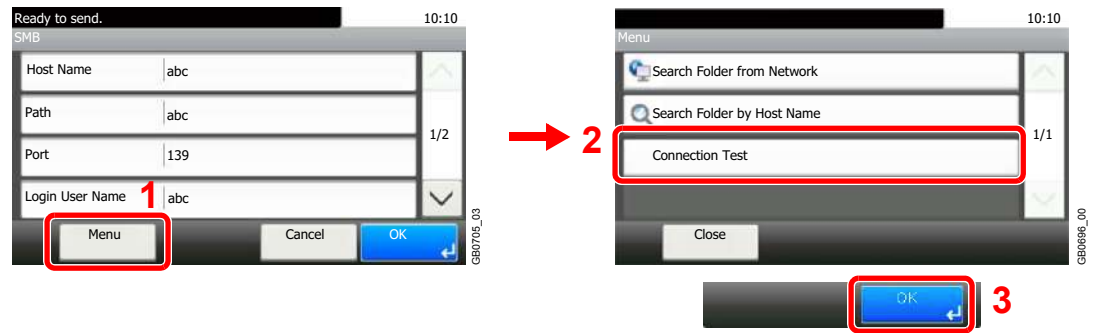

Connected. appears when connection to the destination is correctly established. If *Cannot connect.* appears, review the entry.

3

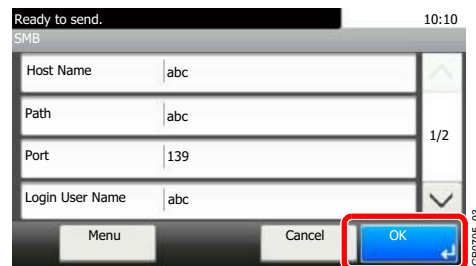

The Folder (FTP) Address

1 Enter *Host Name*, *Path*, *Port*, *Login User Name* and *Login Password*.

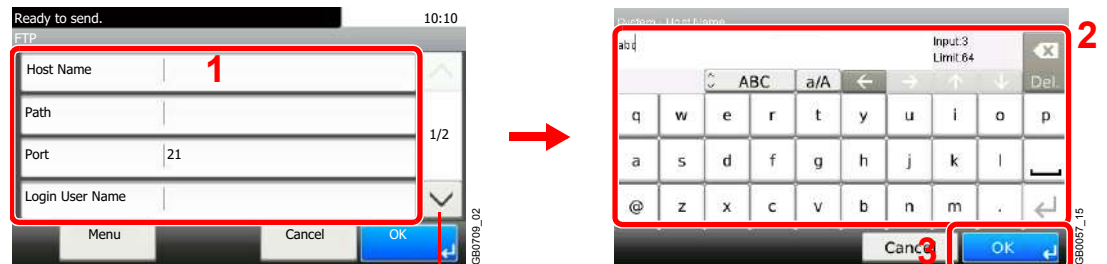

Use [∨] or [∧] to scroll up and down.

 For more information, refer to *Specifying a New PC Folder* on page 6-18.

2 Confirm the connection status.

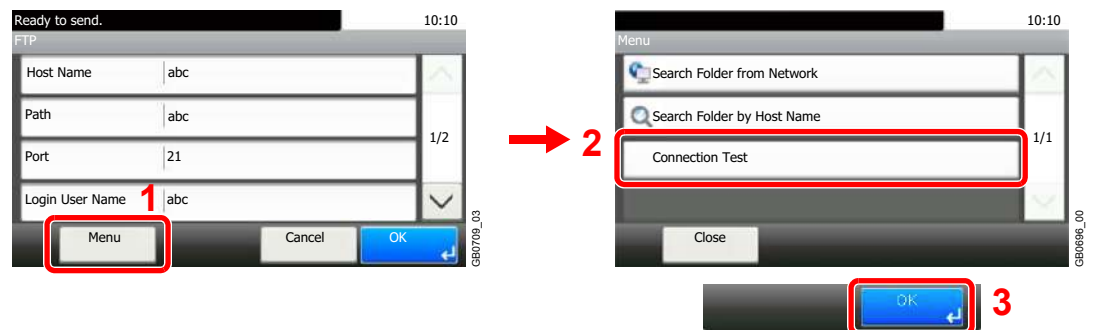

Connected. appears when connection to the destination is correctly established. If *Cannot connect.* appears, review the entry.

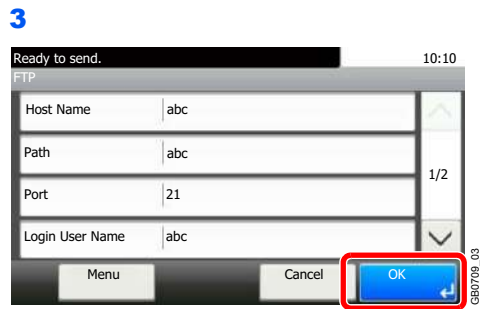

6 Enter the address number.

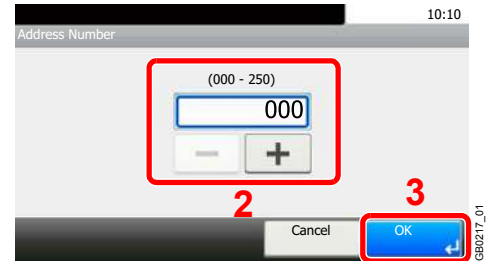
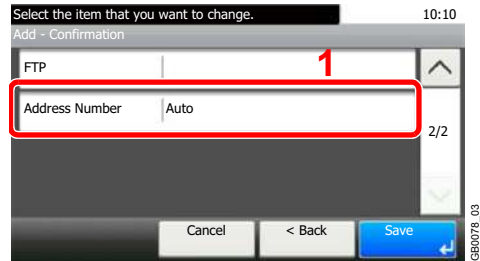

Press [+], [-] or numeric keys to enter a particular Address Number (1-250).

Address Number is an ID for a destination. You can select any available number out of 200 numbers for contacts and 50 numbers for groups.

If you set "000" as the address number, the address is registered under the lowest available number.

7 Register the destination.

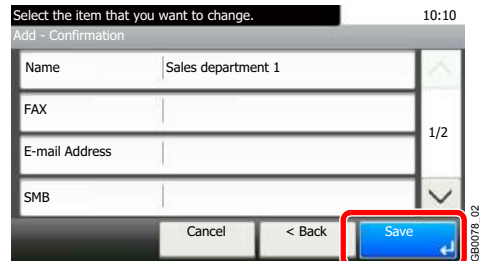

Adding a Group

Compile two or more contacts into a group. Designations in the group can be added at the same time. When adding a group, a maximum of 50 groups can be added in the Address Book.

Before adding a group in the Address Book, the contacts to be included in the group must be added first.

NOTE

If user login administration is enabled, you can only edit destinations in the Address Book by logging in with administrator privileges.

Designations in the group can also be registered in the system menu.

1 Display the screen.

Send



1

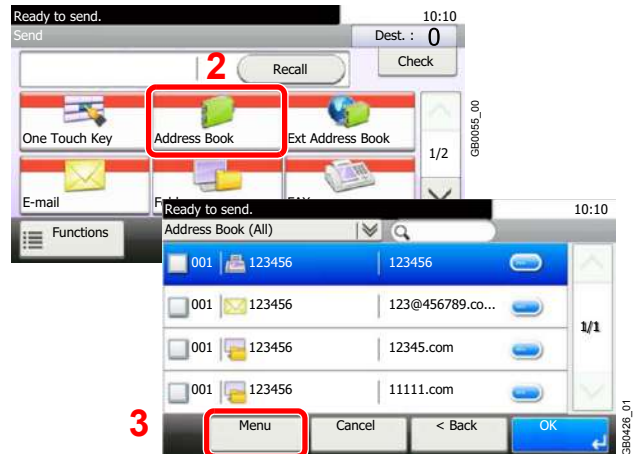

2 Adds a new destination.

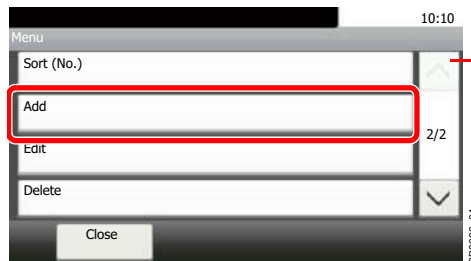

Use [∨] or [∧] to scroll up and down.

3 Select the registration method.

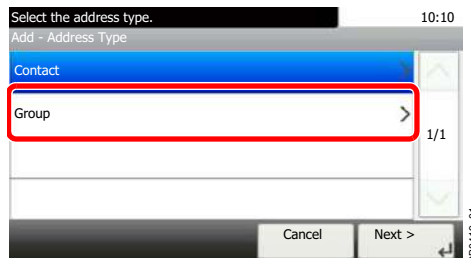

4 Enter the group name.

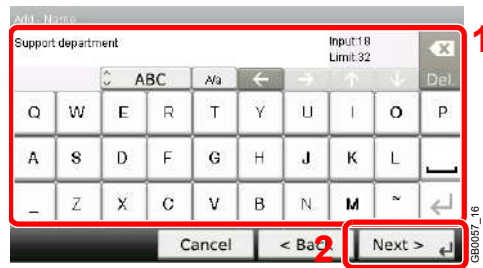

Up to 32 characters can be entered.

Refer to *Character Entry Method* on page 11-8 for details on entering characters.

5 Select the members (destinations).

1 Display the screen.

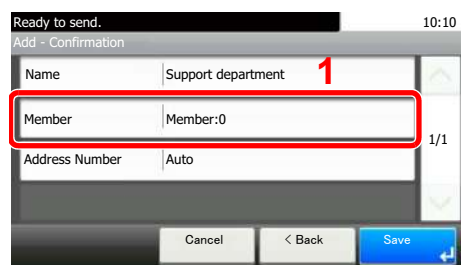

2 Press the checkbox to select the desired destination from the list. The selected destinations are indicated by a checkmark in the check box.

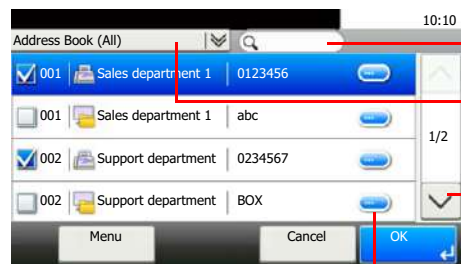

Searches by destination name.

Advanced search by type of registered destination (E-mail, Folder (SMB/FTP) or FAX).

Use [∨] or [∧] to scroll up and down.

Displays details for individual destinations.

You can specify a destination by address number by pressing the **Quick No. Search** key.

You can also press [Menu] to perform a more detailed search.

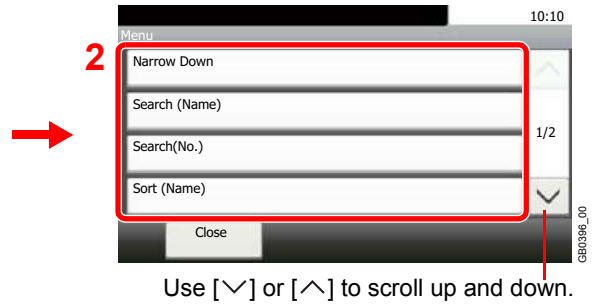
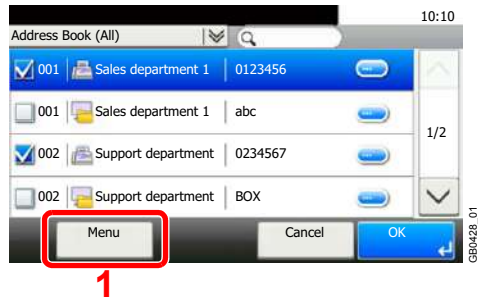

Narrow Down: Advanced search by type of registered destination (E-mail, Folder (SMB/FTP) or FAX).

Search (Name) and Search (No.): Searches by destination name or address number.

Sort (Name) and Sort (No.): Sorts the list by destination name or address number.



NOTE

To cancel a selection, press the corresponding checkbox to clear the check mark.

6 Accept the members.

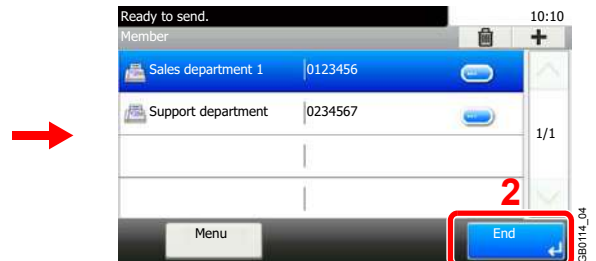
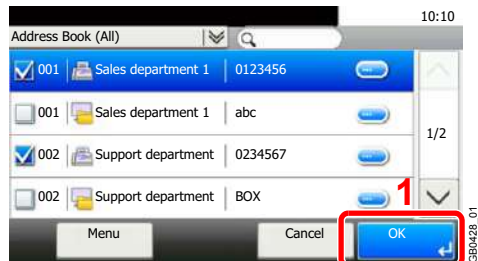

7 Enter the address number.

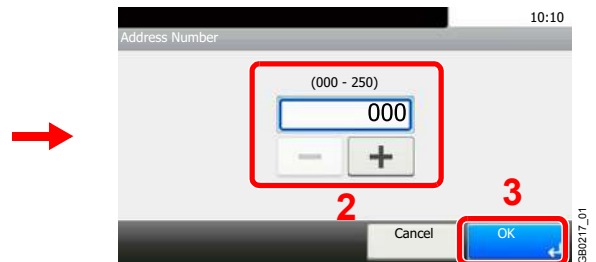
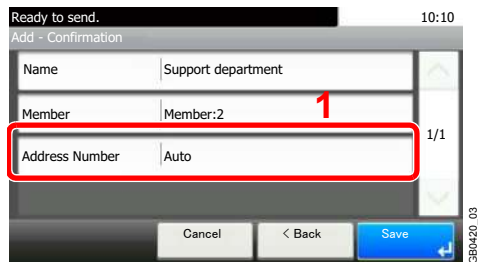

Press [+], [-] or numeric keys to enter a particular Address Number (1-250).

Address Number is an ID for a destination. You can select any available number out of 200 numbers for contacts and 50 numbers for groups.

If you set "000" as the address number, the address is registered under the lowest available number.

8 Register the group.

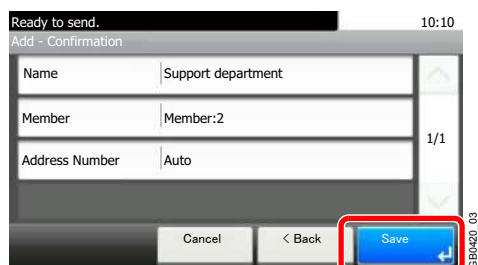

Editing and Deleting Address Book Entries

Edit and delete the destinations (contacts) you added to the Address Book.

1 Display the screen.

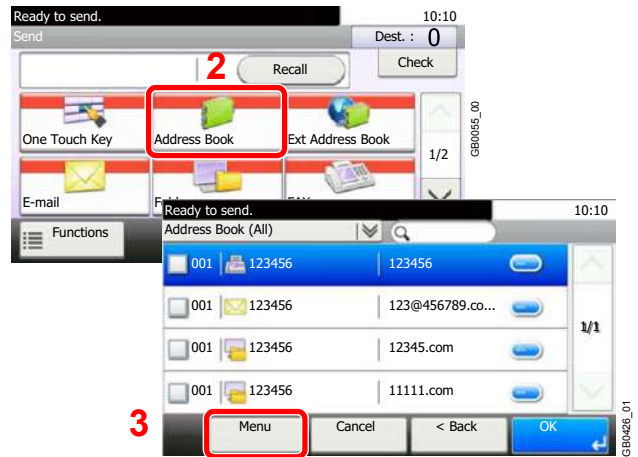

2 Edit or delete the destination.

To edit the destination

1

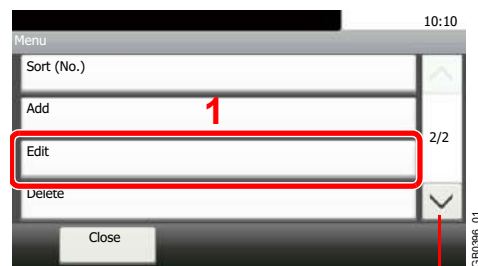

Use [∨] or [∧] to scroll up and down.

2

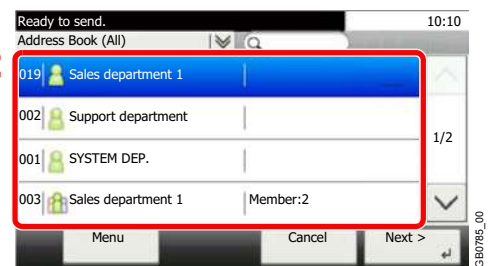

Select the destination (contacts) or group to edit.

You can specify a destination by address number by pressing the **Quick No. Search** key.

2

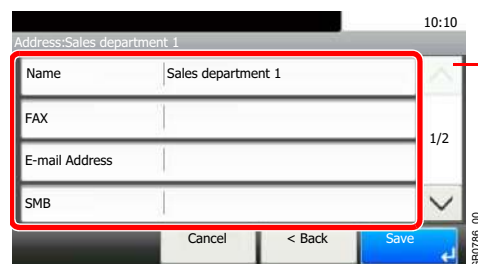

Use [∨] or [∧] to scroll up and down.

Change the information as needed by pressing the item in question.

3

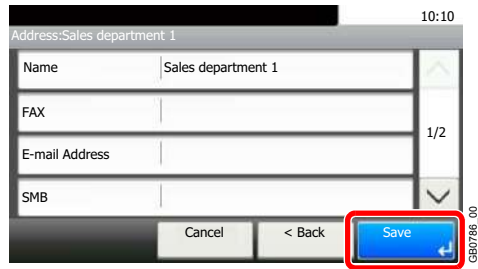

To delete a member (group)

To delete a member from a group, select the destination you wish to delete and press [(Delete)] (the trash can icon).

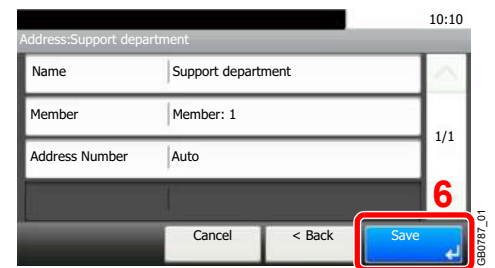
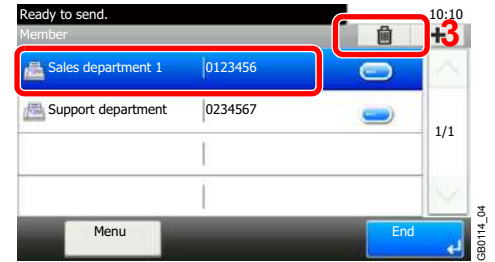
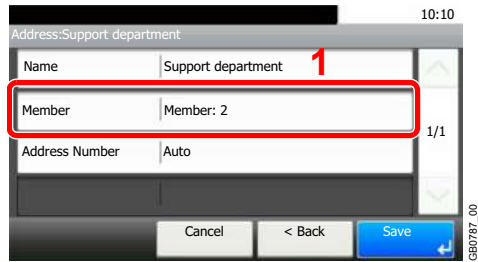

To delete

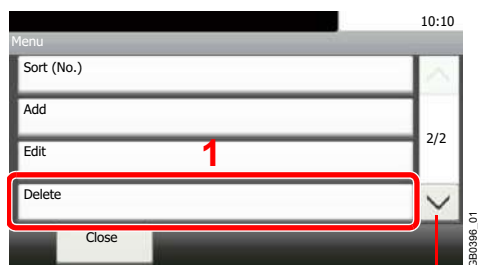

Use [∨] or [∧] to scroll up and down.



Select the destination (contacts) or group to delete.

Adding a Destination on One Touch Key

Add a new destination (contact or group) on One Touch Key.

Adding a Destination

Add a new destination (contact or group). A maximum of 100 destinations can be registered.

To register a destination to a One Touch Key, it must first be registered in the Address Book. Register one or more destinations as needed before proceeding.

1 Display the screen.

◆ System Menu / Counter



1

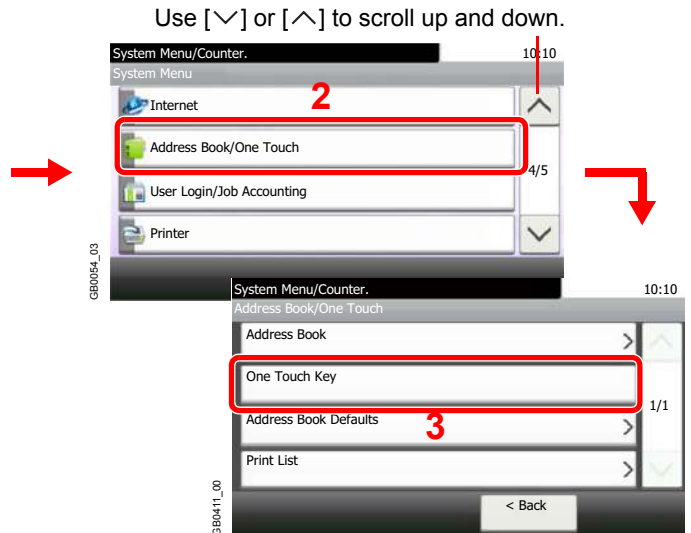

2 Add a One Touch Key.

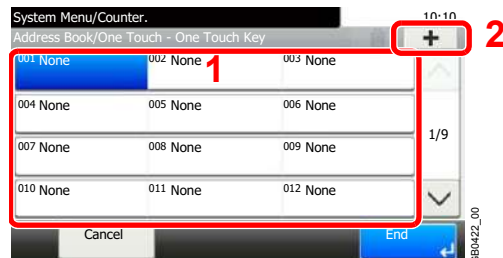

Select a One Touch Key with no registered destination, and press [+].

3 Select the destinations.

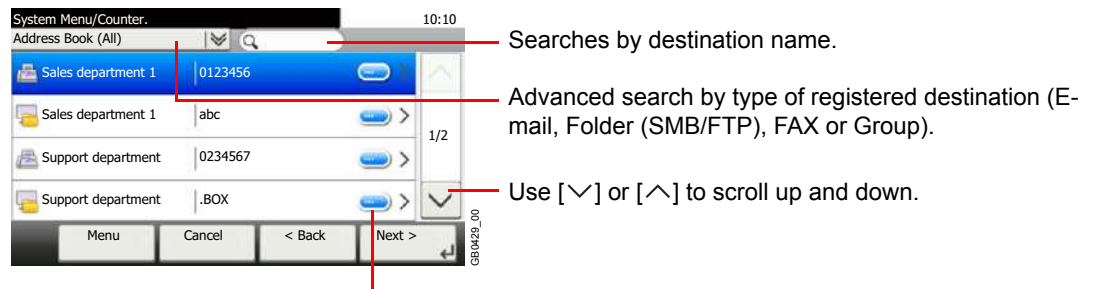

Displays details for individual destinations.

Select one destination (contact or group) from the Address Book.

You can specify a destination by address number by pressing the **Quick No. Search** key.

You can also press [Menu] to perform a more detailed search.

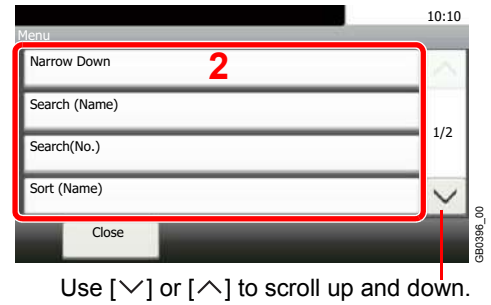
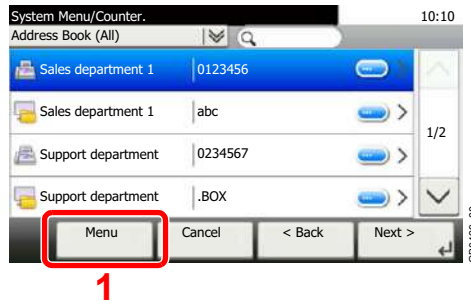

Use [∨] or [∧] to scroll up and down.

Narrow Down: Advanced search by type of registered destination (E-mail, Folder (SMB/FTP), FAX or Group).

Search (Name) and **Search (No.):** Searches by destination name or address number.

Sort (Name) and **Sort (No.):** Sorts the list by destination name or address number.

4 Enter the One Touch Key name.

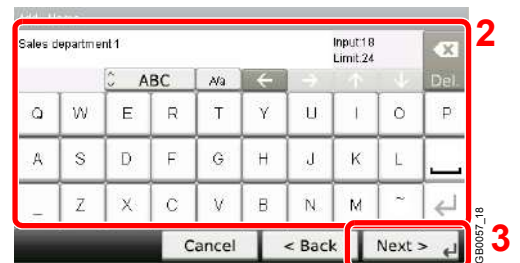
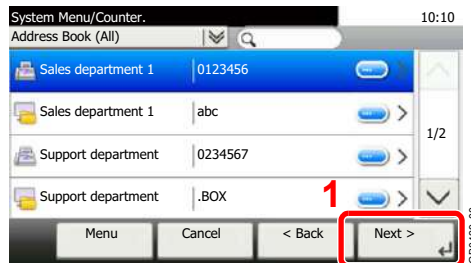

Up to 24 characters can be entered.

 Refer to *Character Entry Method* on page 11-8 for details on entering characters.

5 Register the destination.

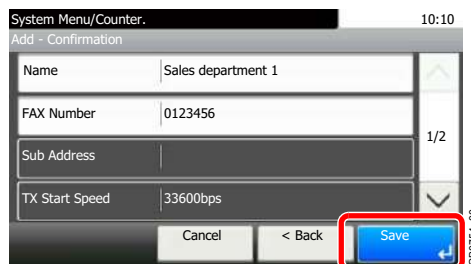

Editing and Deleting One Touch Key

Edit and delete the destinations you added to One Touch Key.

1 Display the screen.

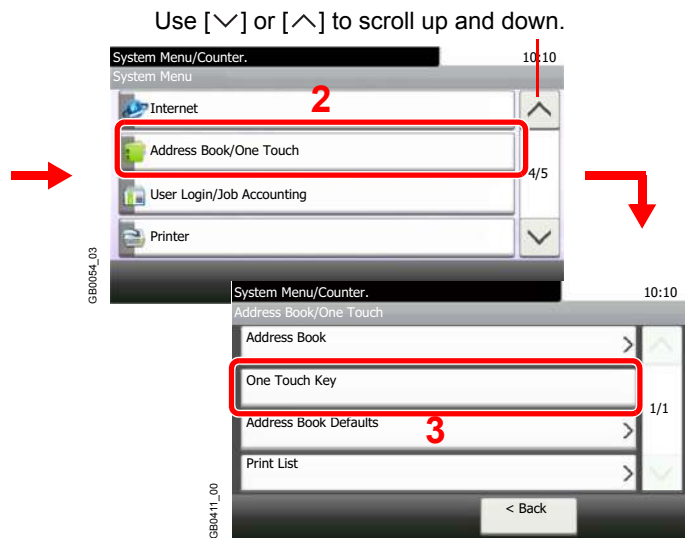
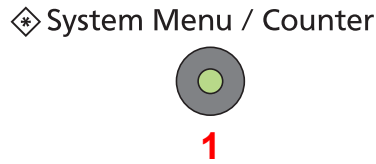

2 Edit or delete the destination.

To edit the destination

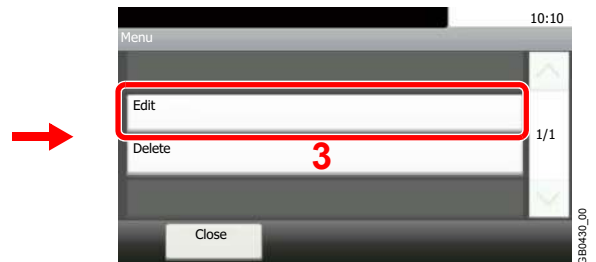
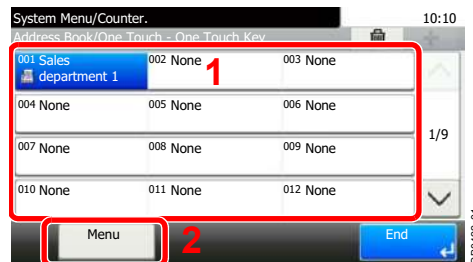

Select the One Touch Key you wish to edit and press [Menu] followed by [Edit].

To delete

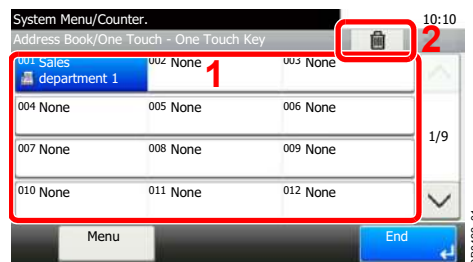

Select the One Touch Key you wish to delete and press [(Delete)] (the trash can icon).

Sending Functions

Send screen shows the commonly used functions. By pressing [Functions], other selectable functions will be shown as a list. Use [∨] or [∧] to select the function.

What do you want to do?	Reference Page
Select the file format for images being sent.	File Format ▶ page 3-50
Specify the original size.	Original Size ▶ page 3-35
Specify the original orientation to scan in the correct direction.	Original Orientation ▶ page 3-36
Automatically scan 2-sided originals.	Duplex ▶ page 3-37
Change the size of the image being sent.	Sending Size ▶ page 6-37
Send each page in a separate file.	File Separation ▶ page 6-39
Set the resolution at which to scan originals.	Scan Resolution ▶ page 3-44
Adjust the density.	Density ▶ page 3-43
Change the color mode for images being sent.	Color Selection ▶ page 3-53
Select original image type for best results.	Original Image ▶ page 3-45
Emphasize the outline of texts or lines. Blur the image outline.	Sharpness ▶ page 3-47
Darken or lighten the background (i.e., the area with no text or images) of originals.	Background Density Adjust ▶ page 3-48
Enlarge or shrink originals according to the sending size.	Zoom ▶ page 3-49
Scan a large number of originals separately and then produce as one job.	Continuous Scan ▶ page 3-39
Add a file name to the job to easily check its status.	File Name Entry ▶ page 3-56
Add an E-mail subject and body (when sending E-mail).	E-mail Subject/Body ▶ page 6-40
Send notice by e-mail when a job is complete.	Job Finish Notice ▶ page 3-54
Encrypt your message.	FTP Encrypted TX ▶ page 6-41
Send a image to a WSD-compatible computer.	WSD Scan ▶ page 6-42



NOTE

This section does not include fax settings. For details on fax operation, refer to the *FAX Operation Guide*. Fax functionality can only be used on products equipped with fax capability.

Sending Size

Select size of image to be sent.

Same as Original Size	Automatically sends the same size as the original.
Metric	Select from A4, A5, A6, B5, B6, Folio or 216 × 340mm.
Inch	Select from Letter, Legal, Statement, Executive or Oficio II.
Others	Select from 16K, ISO B5, Envelope #10, Envelope #9, Envelope #6, Envelope Monarch, Envelope DL, Envelope C5, Hagaki, Oufukuhagaki, Youkei 4 or Youkei 2.

Relationship between Original Size, Sending Size, and Zoom

Original Size (page 3-35), Sending Size, and Zoom (page 3-49) are related to each other. Refer to the following table.

Original Size and the size you wish to send as are	the same	different
Original Size	Specify as necessary	Specify as necessary
Sending Size	Select [Same as Original]	Select the required size
Zoom	Select [100%] (or [Auto])	Select [Auto]

NOTE
When you select Sending Size that is different from Original Size, and select the Zoom [100%], you can send the image as the actual size (No Zoom).

1 Display the screen.

1 Referring to *Basic Operation* on page 6-2, display the screen.

2

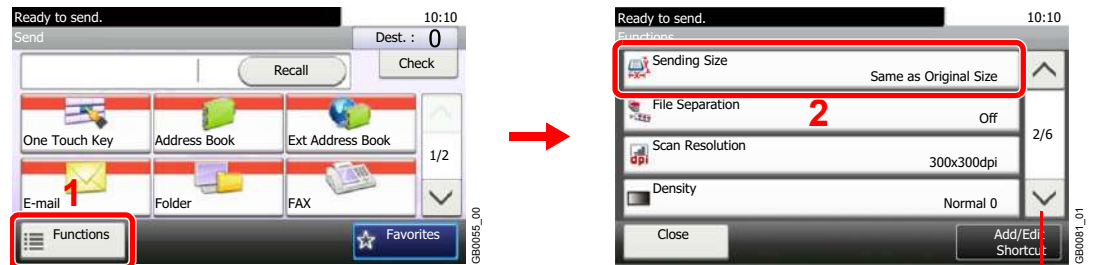

Use [∨] or [∧] to scroll up and down.

2 Select the sending size.

[Same as Original Size]

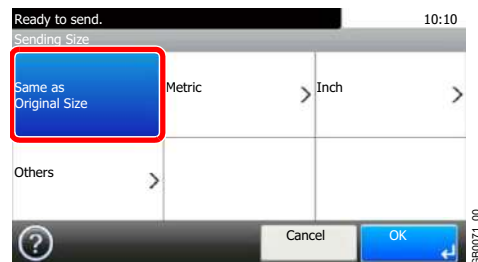

[Metric], [Inch] or [Others]

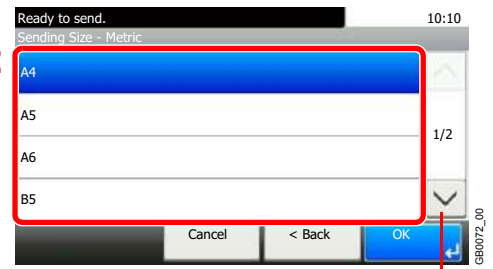
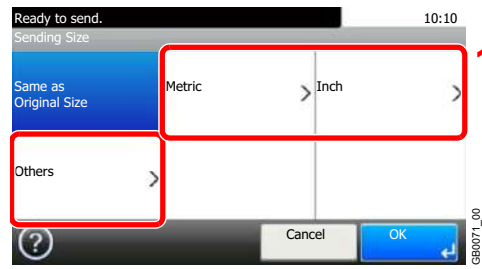

Use [∨] or [∧] to scroll up and down.

Select the desired size.

File Separation

Create several files by dividing scanned original data page by page, and send the files.

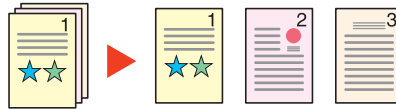

NOTE

Three-digit serial number such as abc_001.pdf, abc_002.pdf... is attached to the end of the file name.

1 Display the screen.

1 Referring to *Basic Operation on page 6-2*, display the screen.

2

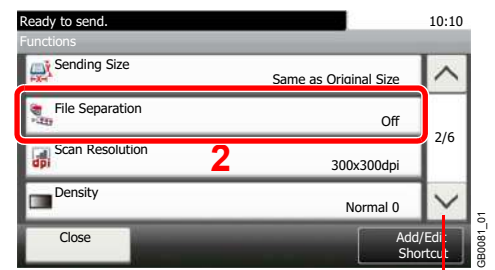

Use [∨] or [∧] to scroll up and down.

2 Select the function.

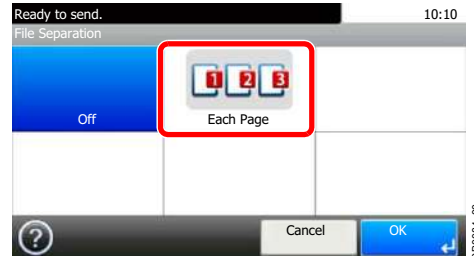

E-mail Subject/Body

Add subject and body when sending a document.

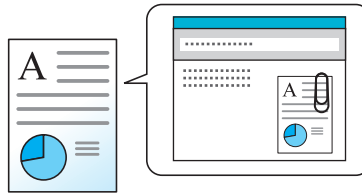

NOTE

The subject can include up to 60 characters, and the body can include up to 500 characters.

1 Display the screen.

1 Referring to *Basic Operation* on page 6-2, display the screen.

2

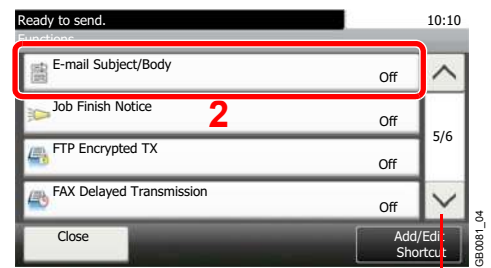

Use [∨] or [∧] to scroll up and down.

2 Enter the subject.

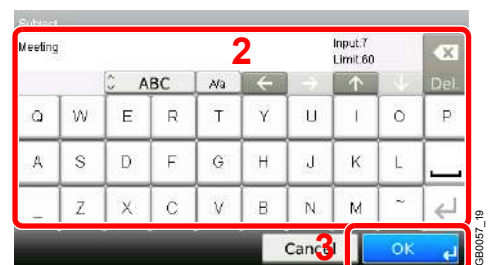
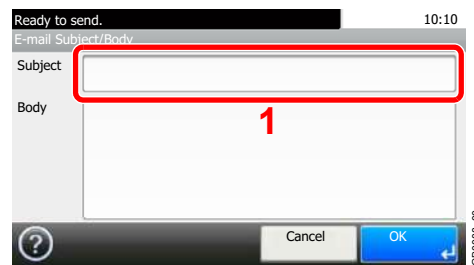

Refer to *Character Entry Method* on page 11-8 for details on entering characters.

3 Enter the body.

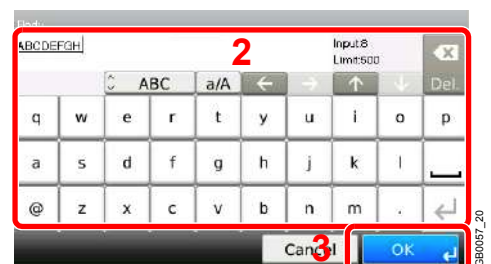
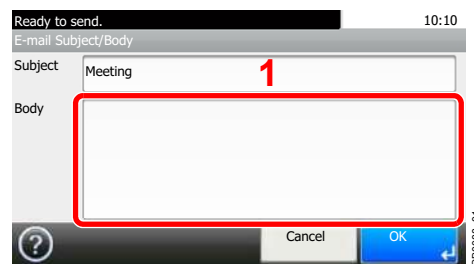

4 Press [OK].

FTP Encrypted TX

Encrypt images when using FTP. Encryption secures the document transmission.

NOTE
To use FTP encryption, set SSL to [On] in the Secure Protocol settings. For details, refer to *Secure Protocol on page 9-22*.

1 Display the screen.

1 Referring to *Basic Operation on page 6-2*, display the screen.

2

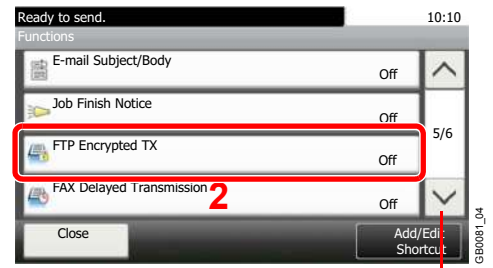

Use [∨] or [∧] to scroll up and down.

2 Select the function.

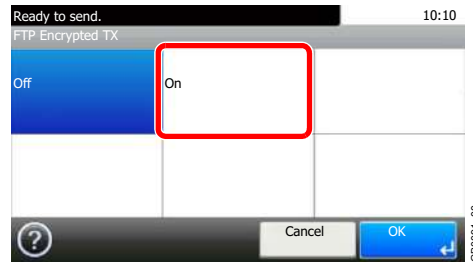

WSD Scan

WSD Scan saves images of originals scanned on this machine as files on a WSD-compatible computer.

 **NOTE**

To use WSD Scan, confirm that the computer used for WSD scanning and the machine is network-connected, and *WSD Scan* (page 9-22) is set to [On] in the network settings.

For information on operating the computer, refer to the computer's help or the operation guide of your software.

Installing Driver Software (for Windows 7)

1 Display the window.

From the Start menu, select **Network**.

2 Install the driver.

Right-click the machine's icon and then click **Install**.

 **NOTE**

If the **User Account Control** window appears, click **Continue**.

If the **Found New Hardware** window appears, click **Cancel**.

During the installation, double-click the icon shown on the task bar to display the **Driver Software Installation** screen. When **Your devices are ready to use** is displayed on the screen, the installation is completed.

Using WSD

1 Press the Send key.

Send



2 Place the originals.

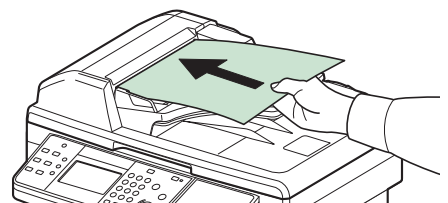
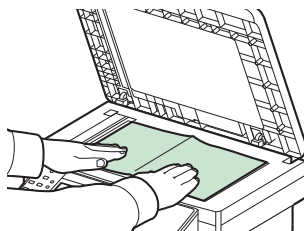

For details, refer to *Loading Originals* on page 3-10.

3 Display the screen.

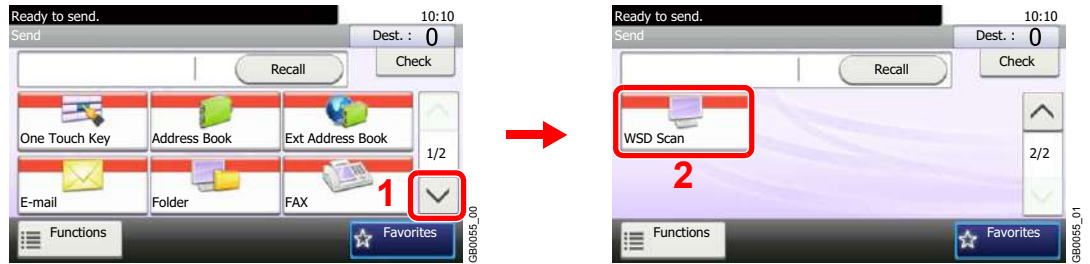

4 Scan the originals.

Procedure using this machine

1

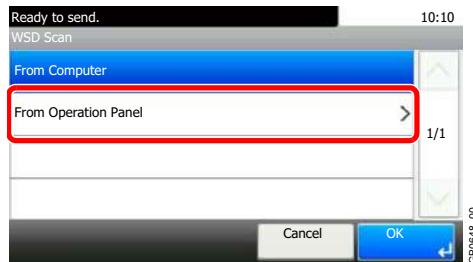

2 Select the destination computer.

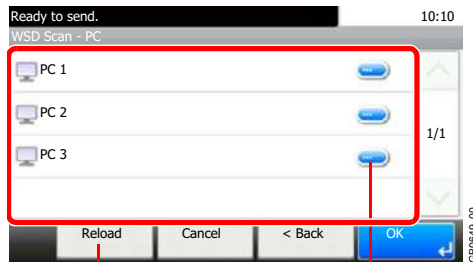

Updates the list.

Displays information for individual destination computers.

3 Press the **Start** key.

Start

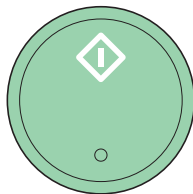

Sending begins and the software installed on the computer is activated.

Procedure from Your Computer

1

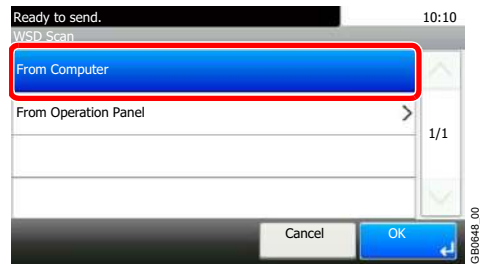

2 Use the software installed on the computer to send the images.

Scanning using TWAIN

This section explains how to scan an original using TWAIN.

The procedure for scanning using the TWAIN driver is explained as an example. The WIA driver is used in the same way.

1 Display the window.

- 1 Activate the TWAIN compatible application.
- 2 Select the machine using the application and display the TWAIN dialog box.



NOTE

For selecting the machine, see the Operation Guide or Help for each application software.

2 Configure the function.

Select scanning settings in the TWAIN dialog box that opens.

Network

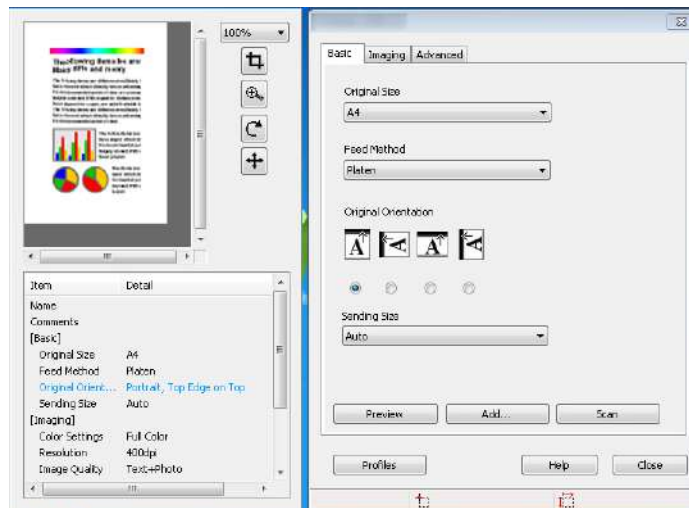

USB

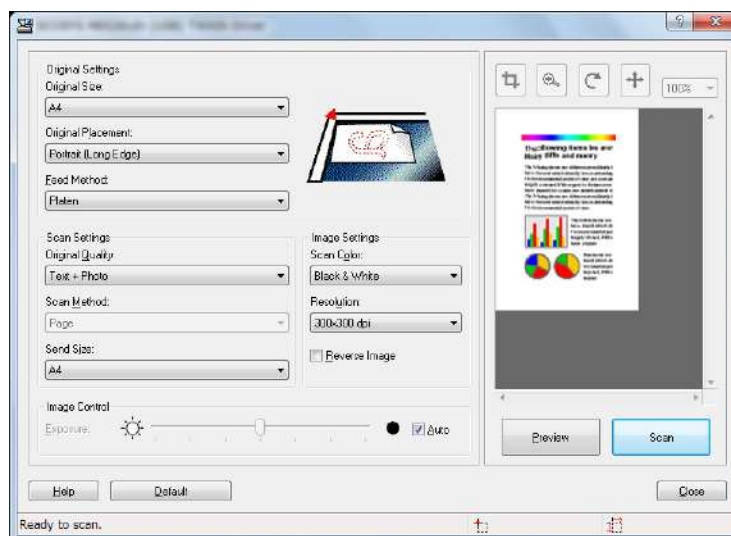

For settings that appear in the TWAIN dialog box, see Help for each application software.

3 Place the originals.

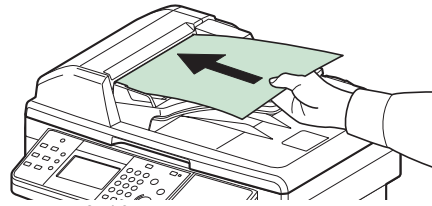
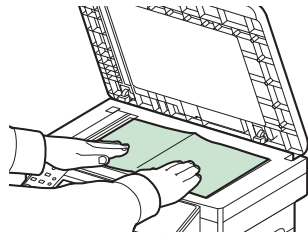

For details, refer to *Loading Originals* on page 3-10.

4 Scan the originals.

Click the **Scan** button. The document data is scanned.

7 Document Box

This chapter explains the following topics:

What is Document Box?	7-2
Using a Custom Box	7-3
Creating a New Custom Box (Add/Edit Box)	7-3
Editing Custom Box	7-8
Storing Documents (Store File)	7-12
Printing Documents (Print)	7-13
Moving a Document	7-15
Auto File Deletion Time	7-16
Printing Documents Stored in Removable USB Memory	7-17
Saving Documents to USB Memory (Scan to USB)	7-20
Removing USB Memory	7-22
Functions for Document Box	7-23
Delete after Printed	7-25
Duplex	7-26
Encrypted PDF Password	7-27
JPEG/TIFF Print	7-28
XPS Fit to Page	7-29
Storing Size	7-30

What is Document Box?

A document box is a place in machine memory that can be used to store document data scanned from the machine, a print job from a computer, or fax data.

The following types of document boxes are available.

Custom Box

Custom Box is a component box which you can create within the Document Box and store data for later retrieval.



NOTE

The optional SSD must be installed.

You can create or delete a Custom Box, and manipulate data in various ways as described below:



Refer to *Creating a New Custom Box (Add/Edit Box)* on page 7-3

Refer to *Editing Custom Box* on page 7-8

Refer to *Storing Documents (Store File)* on page 7-12

Refer to *Printing Documents (Print)* on page 7-13

Refer to *Moving a Document* on page 7-15

Removable Memory Box

A USB memory stick can be connected to the USB port on the machine to print a saved PDF file. You can print PDF data directly from the USB memory without a PC. Image files scanned using this machine can also be saved to USB memory in the PDF, TIFF, JPEG or XPS format (Scan to USB).



Refer to *Printing Documents Stored in Removable USB Memory* on page 7-17.

Refer to *Saving Documents to USB Memory (Scan to USB)* on page 7-20.

Job Box

A print job can be saved in a job box in the machine and printed when needed.



Refer to *Printing Data Saved on the Printer* on page 5-6.

Sub Address Box, Polling Box

Fax data can be saved in Sub Address Box or Polling Box. For details, refer to the *FAX Operation Guide*.

Using a Custom Box

Creating a New Custom Box (Add/Edit Box)

NOTE

The optional SSD must be installed.

If user login administration is enabled, you can only change the settings by logging in with administrator privileges.

The factory default login user name and login password are set as shown below.

Login User Name	2600
Login Password	2600

If user login administration is enabled, log in with administrator privileges to perform the following operations. They cannot be performed with user privileges.

- Creating a box
- Deleting a box of which owner is another user.

The table below lists the items to be set.

Item	Description
Box Name	Enter a box name consisting of up to 32 characters. Refer to <i>Character Entry Method on page 11-8</i> for details on entering characters.
Box No.	Enter the box number by pressing [+], [-] or number keys. The box number can be from 0001 to 1000. A Custom Box should have a unique number. If you enter 0000, the smallest number available will be automatically assigned.
Owner*	Set the owner of the box. Select the owner from the user list that appears.
Permission*	Select whether to share the box.
Box Password	User access to the box can be restricted by specifying a password to protect the box. Entering a password is not mandatory. Enter the same password of up to 16 characters in both [Password] and [Confirm Password].
Usage Restriction	To preserve the hard disk capacity, the storage capacity for a box can be restricted. To enable a capacity restriction enter a value for the storage capacity of the Custom Box in megabytes by pressing [-], [+] or number keys. You can enter a limit between 1 and 30,000 (MB).
Auto File Deletion	Automatically deletes stored documents after a set period of time. Press [On] to enable automatic deletion and then use [+] and [-] or the numeric keys to enter the number of days for which documents are stored. You can enter any number between 1 and 31 (day(s)). To disable automatic file deletion, press [Off].
Free Space	Displays the free space on the box.
Overwrite Setting	Specifies whether or not old stored documents are overwritten when new documents are stored. To overwrite old documents, press [Permit]. To retain old documents, press [Prohibit].
Delete after Printed	Automatically delete a document from the box once printing is complete. To delete the document, press [On]. To retain the document, press [Off].

* Displayed when the user login administration is enabled.

1 Display the screen.

Document Box

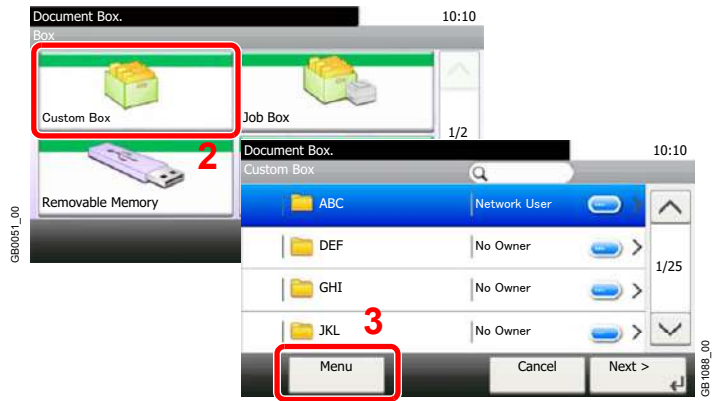

2 Add the custom box.

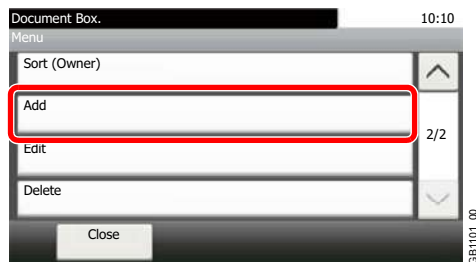

3 Enter the box name.

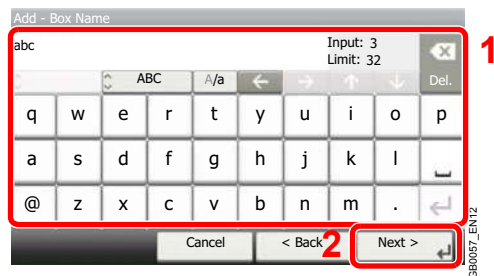

4 Confirm the information.

Check the information. Change the information as needed by pressing the item in question.

[Box Name]

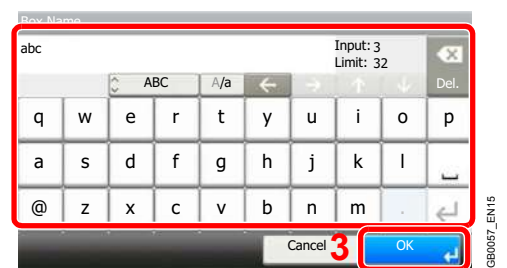
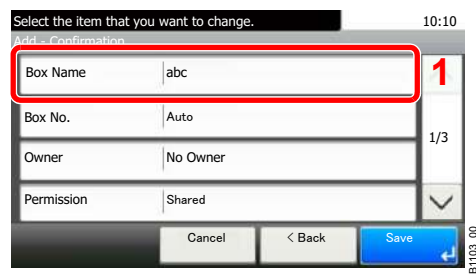

[Box No.]

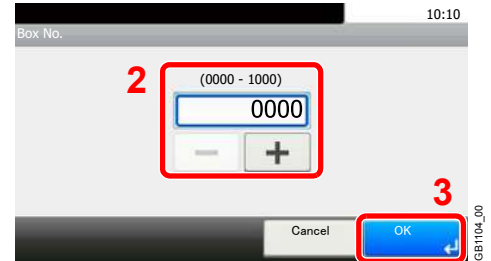
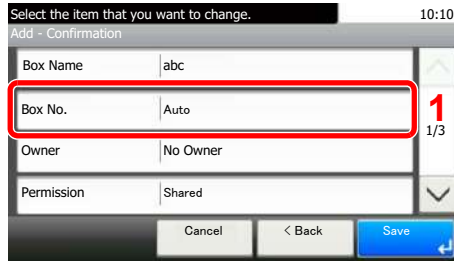

[Owner]

When selecting [Local User]

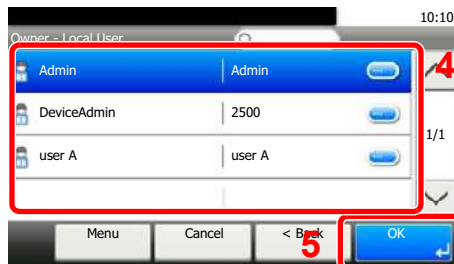
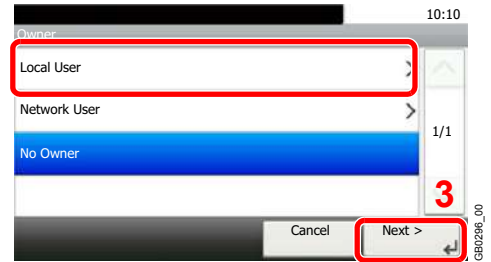
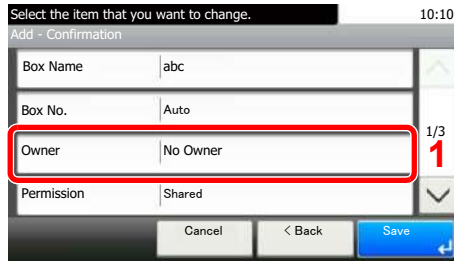

When selecting [Network User]

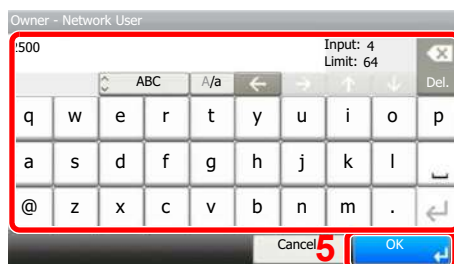
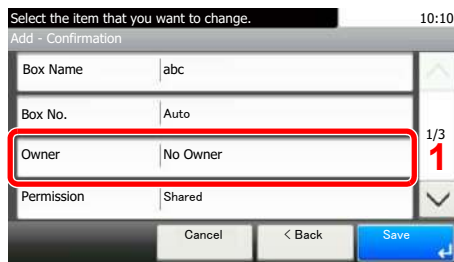

Displayed when the user login administration is enabled.

[Permission]

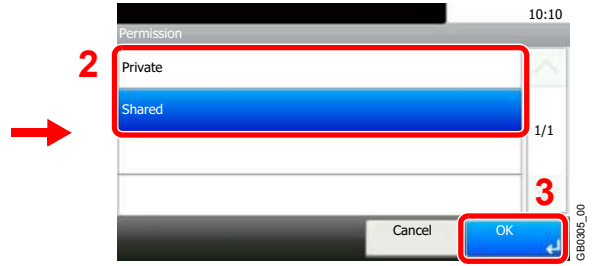
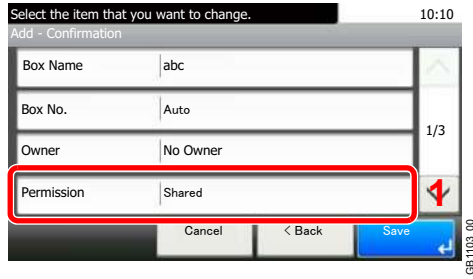

Displayed when the user login administration is enabled.

[Box Password]

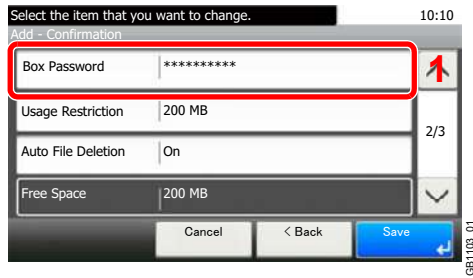

Enter the same login password twice for confirmation purposes.

[Usage Restriction]

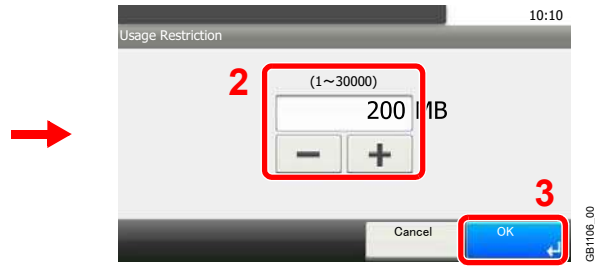
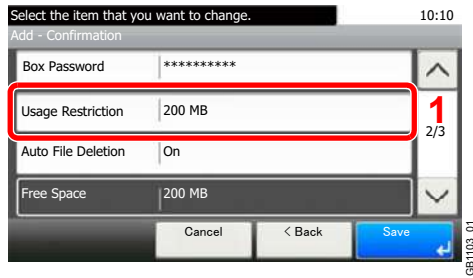

[Auto File Deletion]

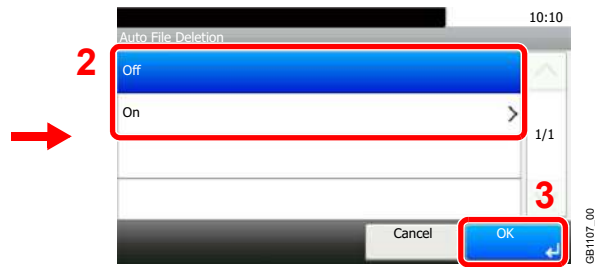
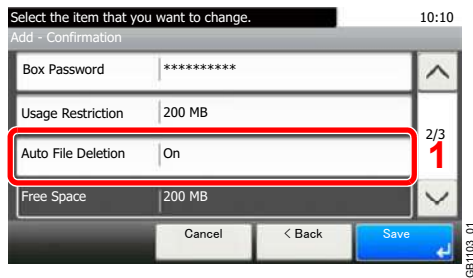

[Overwrite Setting]

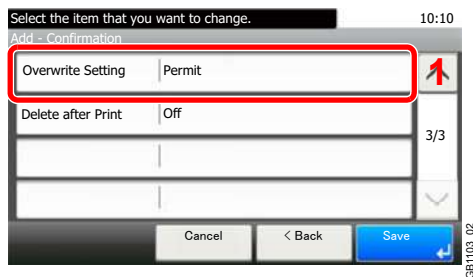

[Delete after Print]

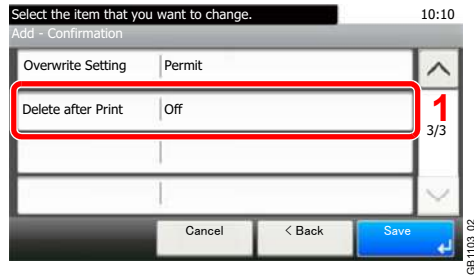

5 Register the custom box.

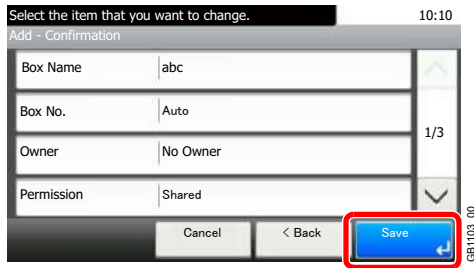

Editing Custom Box

1 Display the screen.

Referring to *Creating a New Custom Box (Add/Edit Box)* on page 7-3, display the screen for editing the custom box.

2 Editing and Deleting the custom box.

To edit the custom box

1



2



Searches by user name.

3 Edit the custom box.

When user login administration is enabled, the settings that can be changed varies depending on the privileges of the logged in user.

Privileges	Settings that can be changed
Administrator	Box Name
	Box No.
	Owner
	Permission
	Box Password
	Usage Restriction
	Auto File Deletion
	Overwrite Setting
Delete after Printed	

Privileges	Settings that can be changed
User	Box Name
	Box Password
	Permission
	Auto File Deletion
	Overwrite Setting
	Delete after Printed

 For details, refer to *Creating a New Custom Box (Add/Edit Box)* on page 7-3.

[Box Name]

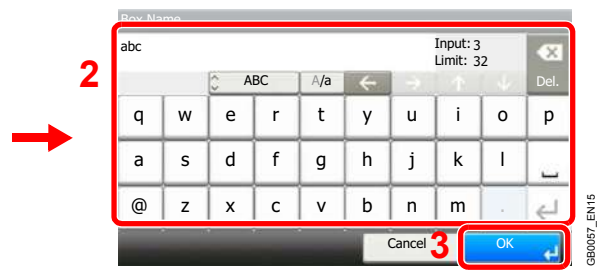
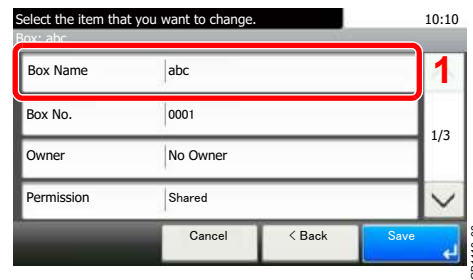

[Box No.]

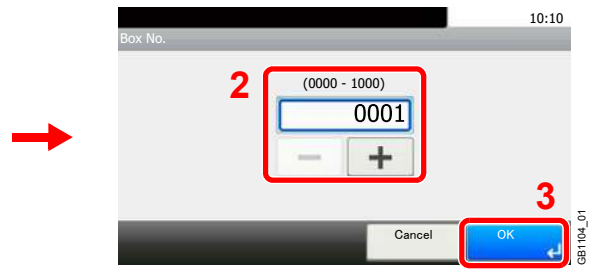
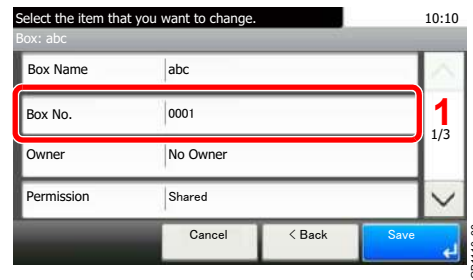

[Owner]

When selecting [Local User]

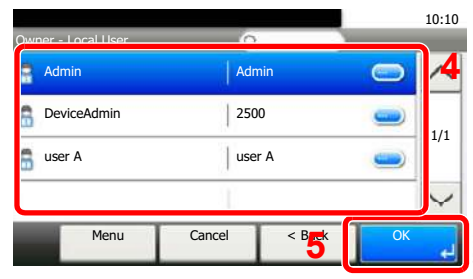
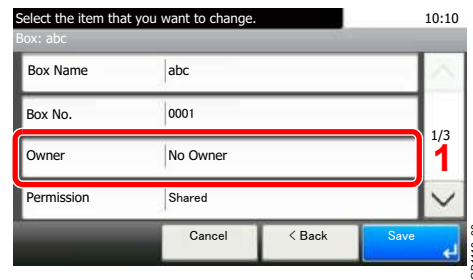

When selecting [Network User]

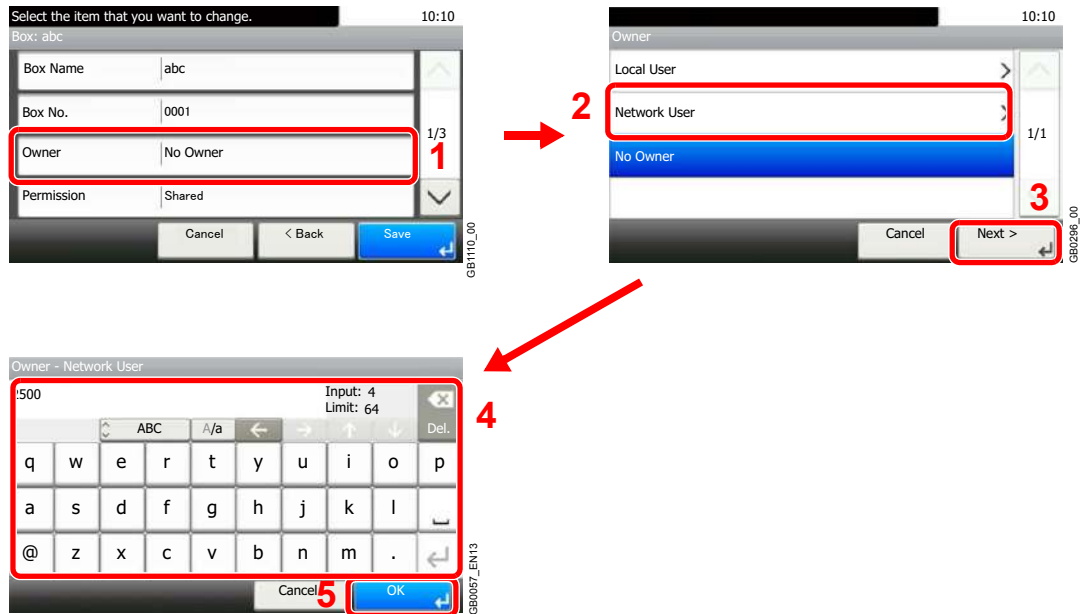

Displayed when the user login administration is enabled.

[Permission]

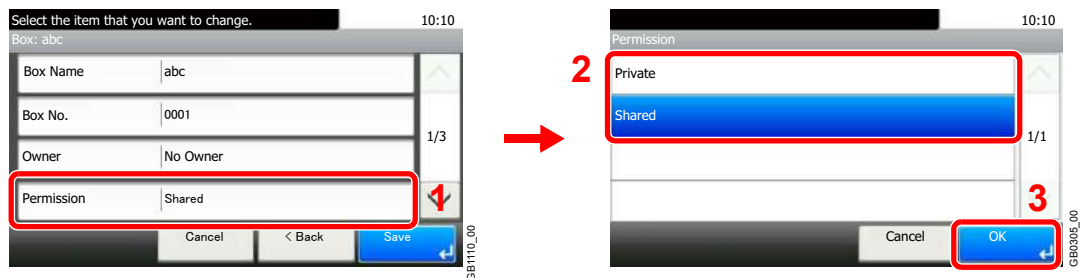

Displayed when the user login administration is enabled.

[Box Password]

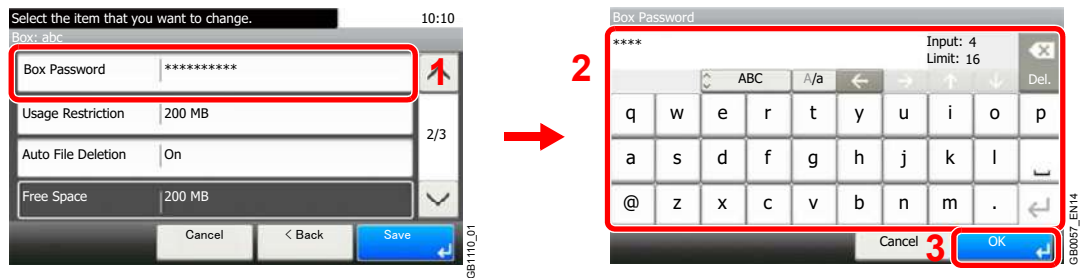

Enter the same login password twice for confirmation purposes.

[Usage Restriction]

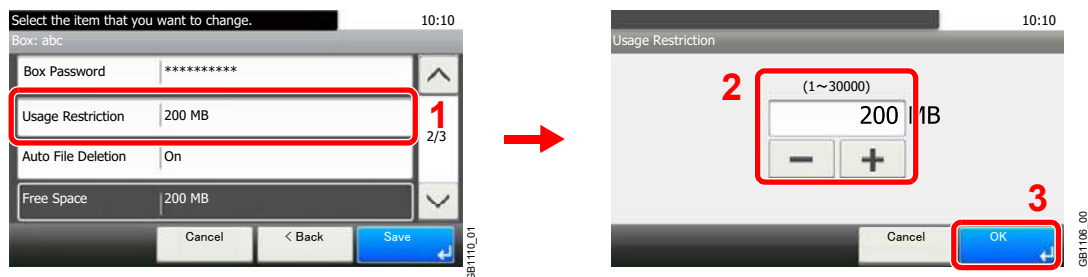

[Auto File Deletion]

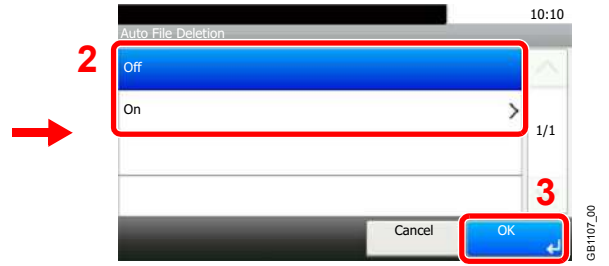
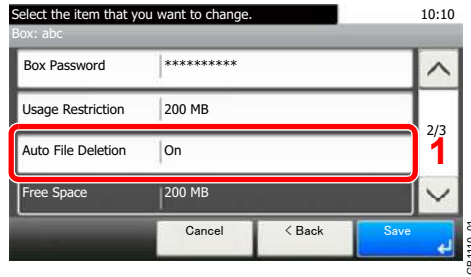

[Overwrite Setting]

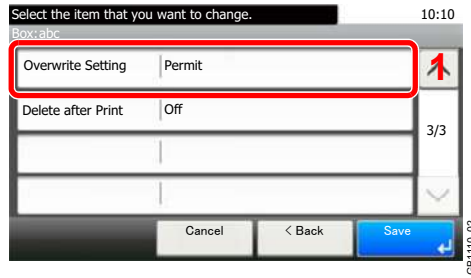

[Delete after Print]

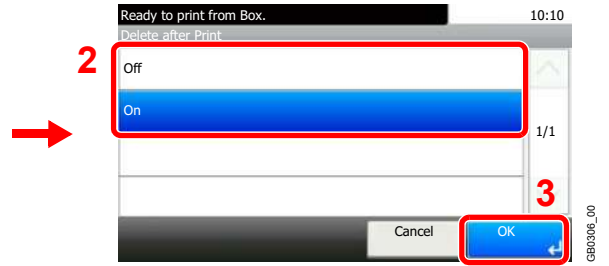
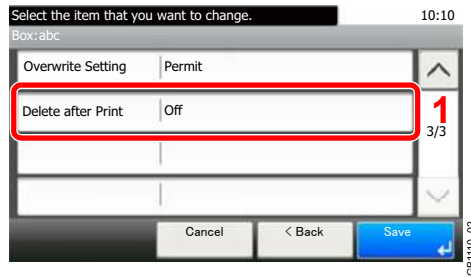

4 Register the custom box.



To delete the custom box

1

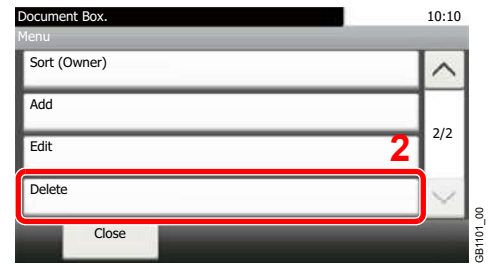

2 Register the custom box.



Storing Documents (Store File)

Documents created on a computer can be stored in a Custom Box. For more information, refer to the *Printer Driver Operation Guide*.

Printing Documents (Print)

1 Display the screen.

1

Document Box

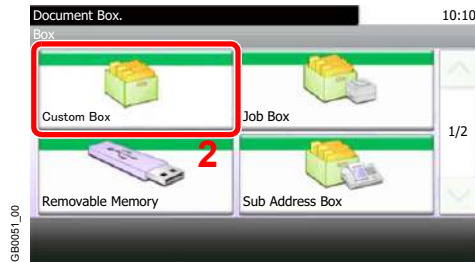
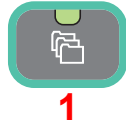

2



NOTE

If a custom box is protected by a password, enter the correct password.

2 Select the file.

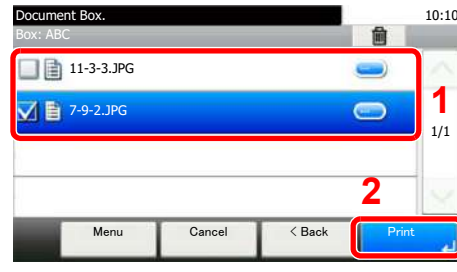

Select the file to be printed and press [Print].

3 Selecting the print method.

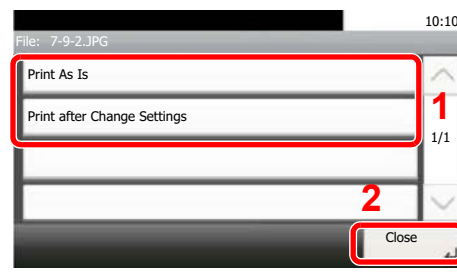

If you selected [Print As Is], go to step 5.

If you selected [Print after Change Settings], go to step 4.

4 Select the functions.

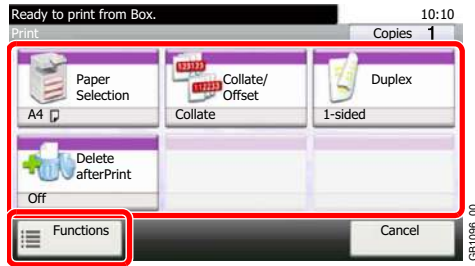

Select the function to use for Document Box.

Press [Functions] to display other functions.



For details, refer to *Functions for Document Box* on page 7-23.

5 Enter the quantity.

Select [Print As Is] in step 3.

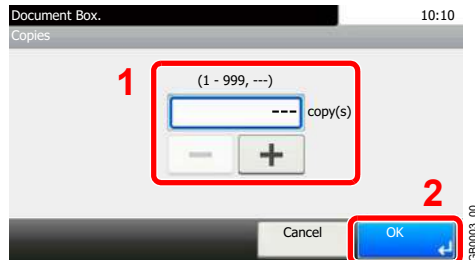

Press the [OK] to start printing.

Select [Print after Change Settings] in step 3.



NOTE

Press the **Clear** key to change the copy quantity.

Press the **Start** key to start printing.

Moving a Document

1 Display the screen.

Referring to *Printing Documents (Print)* on page 7-13, display the screen.

2 Select the file.



Select the file to be moved and press [Menu].

3 Move documents.

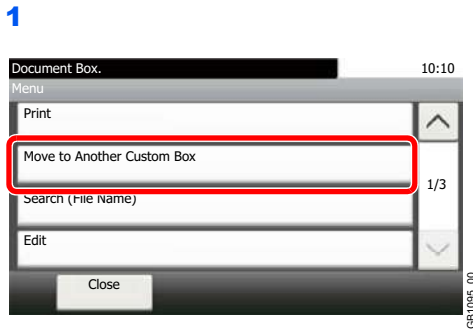

2

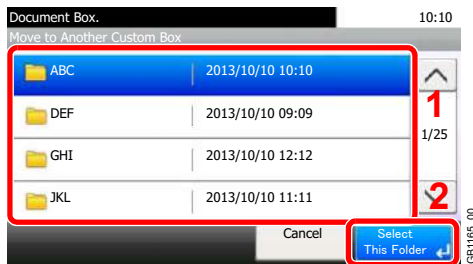

NOTE

If the box to which the document is to be moved or copied is protected by a password, enter the correct password.

Auto File Deletion Time

Set the time to automatically delete stored documents.

1 Display the screen.

◆ System Menu / Counter

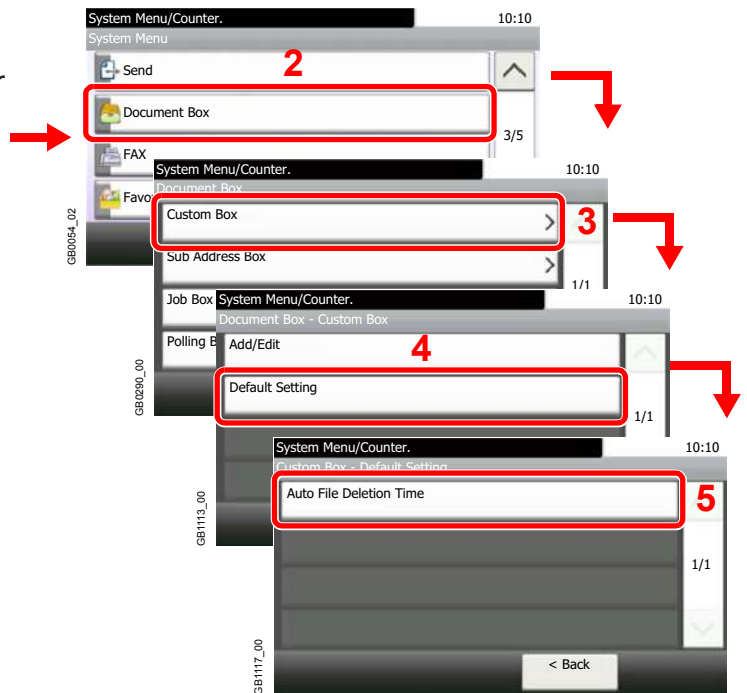
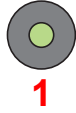

2 Enter the time to automatically delete stored documents.

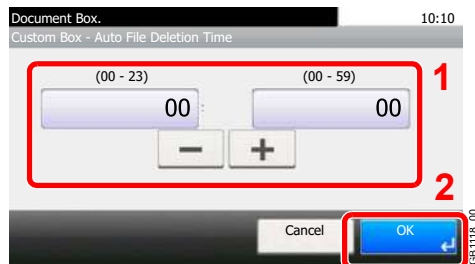

Printing Documents Stored in Removable USB Memory

Plugging USB memory directly into the machine enables you to quickly and easily print the files stored in the USB memory without having to use a computer.

The following file types can be printed:

- PDF file (Version 1.7)
- TIFF file (TIFF V6/TTN2 format)
- JPEG file
- XPS file
- Encrypted PDF file

PDF files you wish to print should have an extension (.pdf).

Files to be printed should be saved no further down than the top 3 folder levels.

Use USB memory properly formatted by this machine.

Plug the USB memory directly into the USB memory slot. We do not guarantee that USB memory printing is error free if a USB hub is used.

1 Plug the USB memory.

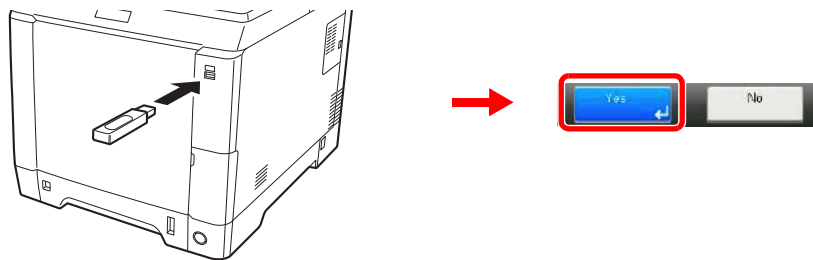

Plug the USB memory into the USB memory slot.

When the message *Removable Memory is recognized. Displaying files. Are you sure?* is displayed, press [Yes].

IMPORTANT

Use USB memory formatted by this machine. If a USB memory formatted by any other device is used, *The removable memory is not formatted.* may appear.



Refer to *Check of Device Status* on page 8-13.

2 Display the screen.

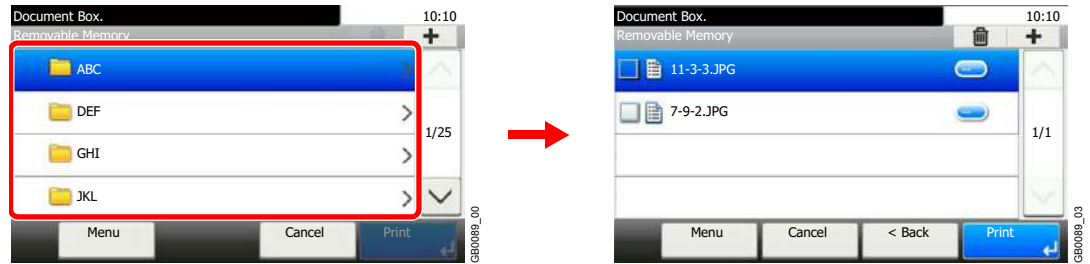

1 When the machine reads the USB memory, *Removable Memory* screen may appear.



NOTE

If the screen does not appear, press the **Document Box** key and then [Removable Memory].

2 Select and open the folder in which the file you wish to print is stored.

The machine will display documents in the top 3 folder levels, including the root folder. To return to a higher level folder, press [< Back].

3 Select the file.

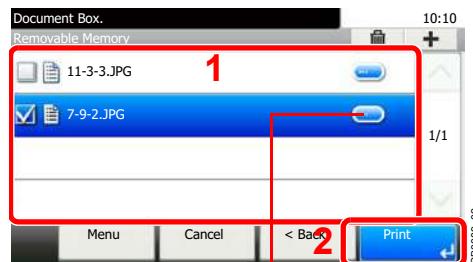

Displays details for individual files.

Select the file to be printed and press [Print].

4 Enter the quantity.



NOTE

Press the **Clear** key to change the copy quantity.

5 Select the functions.

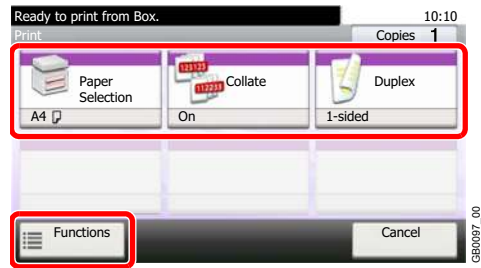

Select the function to use for Document Box.

Press [Functions] to display other functions.

 For details, refer to *Functions for Document Box* on page 7-23.

6 Start printing.

Start

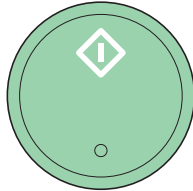

Press the **Start** key to start printing.

Remove the USB memory.

 For details, refer to *Removing USB Memory* on page 7-22.

Saving Documents to USB Memory (Scan to USB)

This function allows you to store scanned image files in USB memory connected to the machine. You can store files in PDF, TIFF, JPEG or XPS format.

1 Place the originals.

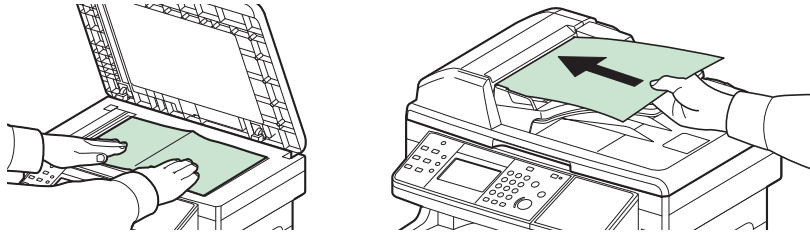

 For details, refer to *Loading Originals* on page 3-10.

2 Plug the USB memory.

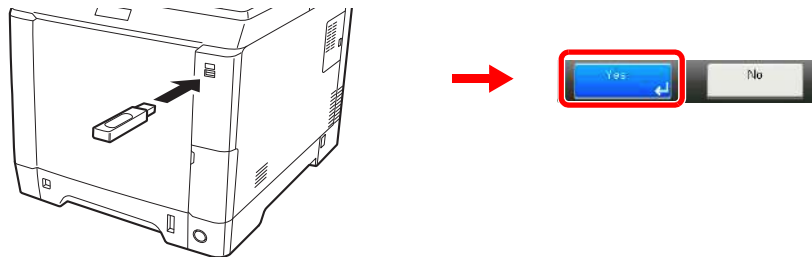

Plug the USB memory into the USB memory slot.

When the message *Removable Memory is recognized. Displaying files. Are you sure?* is displayed, press [Yes].

 **IMPORTANT**
Use USB memory formatted by this machine. If a USB memory formatted by any other device is used, *The removable memory is not formatted.* may appear.

 Refer to *Check of Device Status* on page 8-13.

3 Display the screen.



When the machine reads the USB memory, *Removable Memory* screen may appear.

 **NOTE**
If the screen does not appear, press the **Document Box** key and then [Removable Memory].

4 Select the folder.

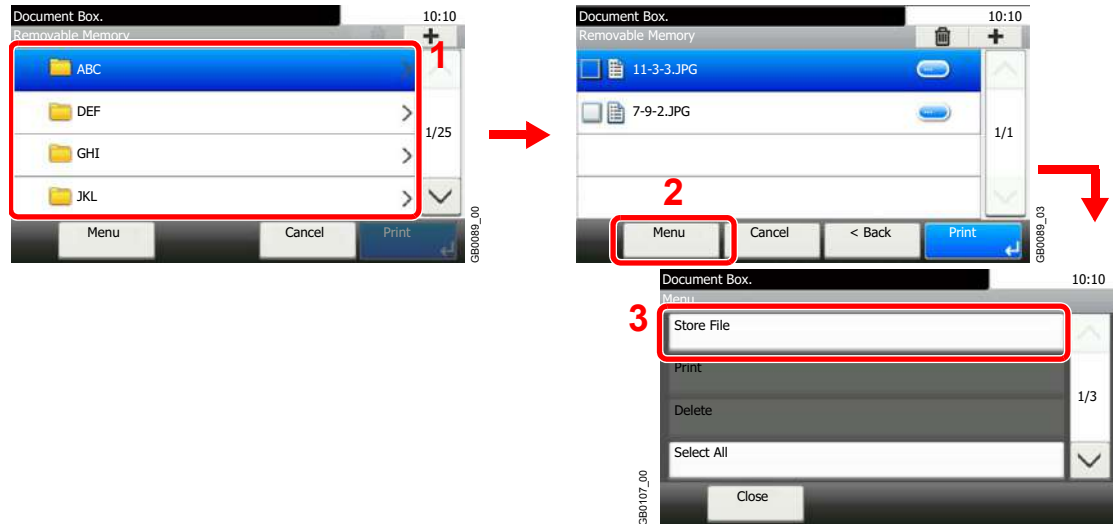

Select the folder where the file will be stored and press [Menu] and then [Store File].

The machine will display the top 3 folder levels, including the root folder. To return to a higher level folder, press [< Back].



NOTE

Up to 1,000 documents and folders can be displayed for each directory. If the number of documents and folders in a directory exceeds 1,000, you will be unable to save additional documents.

5 Select the functions.

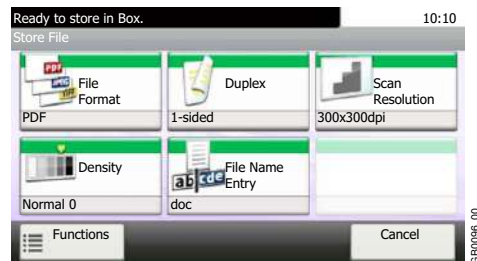

Select the function to use for Document Box.

Press [Functions] to display other functions.



For details, refer to *Functions for Document Box* on page 7-23.

6 Start storing.

Start

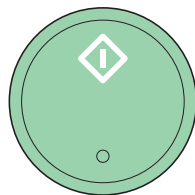

Press the **Start** key to start storing.

Remove the USB memory.



For details, refer to *Removing USB Memory* on page 7-22.

Removing USB Memory

Certain operations must be performed on the screen before USB memory can be removed.



IMPORTANT

Be sure to follow the proper procedure to avoid damaging the data or USB memory.

1 Display the screen.

Document Box

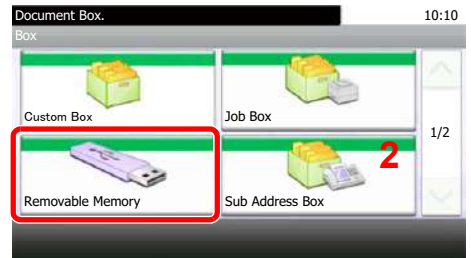

2 Select [Remove Memory].



Use [∨] or [∧] to scroll up and down.

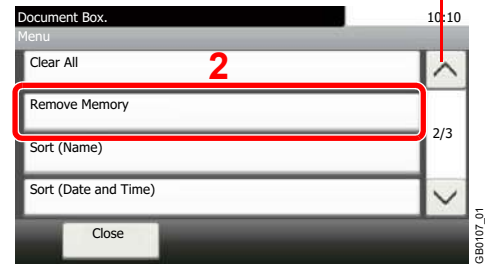

3 Remove the USB memory.

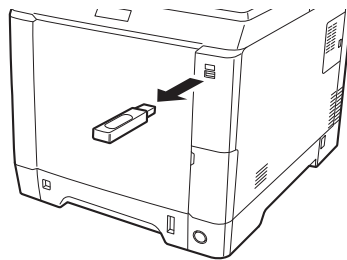

After *Removable Memory can be safely removed.* is displayed, press [OK] and remove the USB memory.



NOTE

USB memory can also be removed after checking the status of the device.



For details, refer to *Check of Device Status* on page 8-13.

Functions for Document Box

Print or Store file screen in Document Box shows the commonly used functions. By pressing [Functions], other selectable functions will be shown as a list. Use [v] or [^] to select the function.

When printing from Custom Box

What do you want to do?	Reference Page
Specify the paper size and type.	Paper Selection ► page 3-41
Collate the output documents in page order.	Collate ► page 3-42
Print on both sides of the paper.	Duplex ► page 7-26
Automatically deletes a document from the box once printing is complete.	Delete after Printed ► page 7-25
Suspend the current job and override it to give a new job top priority.	Priority Override ► page 3-57
Adds a file name.	File Name Entry ► page 3-56
Send notice by e-mail when a job is complete.	Job Finish Notice ► page 3-54
EcoPrint saves toner when printing.	EcoPrint ► page 3-46

When printing from USB memory

What do you want to do?	Reference Page
Specify the paper size and type.	Paper Selection ► page 3-41
Collate the output documents in page order.	Collate ► page 3-42
Print on both sides of the paper.	Duplex ► page 7-26
Change the color mode.	Color Selection ► page 3-53
EcoPrint saves toner when printing.	EcoPrint ► page 3-46
Send notice by e-mail when a job is complete.	Job Finish Notice ► page 3-54
Suspend the current job and override it to give a new job top priority.	Priority Override ► page 3-57
Password-protect a PDF file.	Encrypted PDF Password ► page 7-27
Set the image size (resolution) when printing a JPEG or TIFF file.	JPEG/TIFF Print ► page 7-28
Print an XPS file so that it fits the paper size.	XPS Fit to Page ► page 7-29

When storing a document to USB memory

What do you want to do?	Reference Page
Select the file format for images being stored.	File Format ► page 3-50
Automatically scan 2-sided originals.	Duplex ► page 3-37
Set the resolution at which to scan originals.	Scan Resolution ► page 3-44
Adjust the density.	Density ► page 3-43
Add a file name to the job to easily check its status.	File Name Entry ► page 3-56
Specify the original size.	Original Size ► page 3-35
Specify the original orientation to scan in the correct direction.	Original Orientation ► page 3-36
Change the size at which to store an image	Storing Size ► page 7-30
Change the color mode for images being stored.	Color Selection ► page 3-53
Select original image type for best results.	Original Image ► page 3-45
Emphasize the outline of texts or lines. / Blur the image outline.	Sharpness ► page 3-47
Darken or lighten the background (i.e., the area with no text or images) of originals.	Background Density Adjust ► page 3-48
Enlarge or shrink originals according to the storing size.	Zoom ► page 3-49
Scan a large number of originals separately and then produce as one job.	Continuous Scan ► page 3-39
Send notice by e-mail when a job is complete.	Job Finish Notice ► page 3-54
Creates several files by dividing scanned original data page by page before sending the files.	File Separation ► page 6-39

Delete after Printed

Automatically deletes a document from the box once printing is complete.

1 Display the screen.

1 Referring to *Printing Documents (Print)* on page 7-13, display the screen.

2

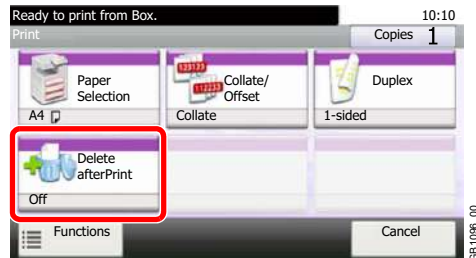

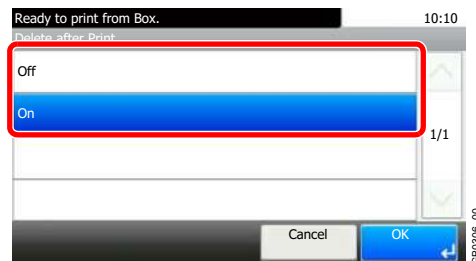

2 Select the function.



Duplex

Print a document 1-sided or 2-sided. Select the original binding orientation and desired final binding orientation.

 <p>2-sided</p>	<p>Print a 2-sided document so that the sheets are aligned properly for binding on the left or right</p>
 <p>2-sided</p>	<p>Print a 2-sided document so that the sheets are aligned properly for binding on the top.</p>

1 Display the screen.

- 1 Referring to *Printing Documents Stored in Removable USB Memory on page 7-17*, display the screen.

2

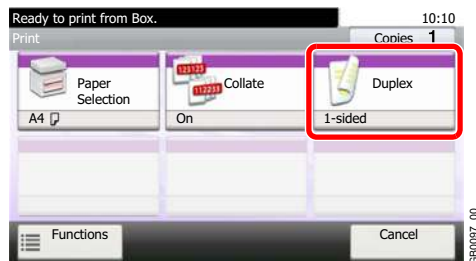

2 Select the function.

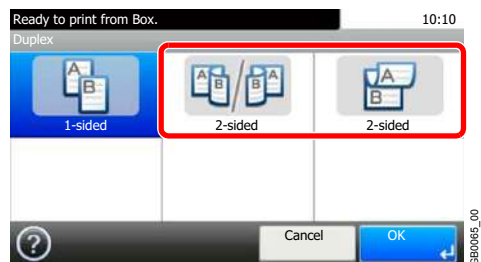

Encrypted PDF Password

Enter the preassigned password to print the PDF data.

1 Display the screen.

1 Referring to *Printing Documents Stored in Removable USB Memory on page 7-17*, display the screen.

2



Use [∨] or [∧] to scroll up and down.

2 Enter the password.

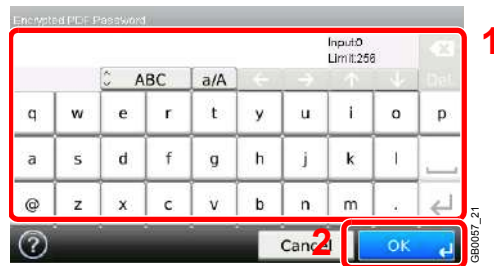

Up to 256 characters can be entered.

 Refer to *Character Entry Method on page 11-8* for details on entering characters.

JPEG/TIFF Print

Select the image size when printing JPEG or TIFF files.

Paper Size	Fit the image size to the selected paper size.
Image Resolution	Print at resolution of the actual image.
Print Resolution	Fit the image size to the print resolution.

1 Display the screen.

1 Referring to *Printing Documents Stored in Removable USB Memory on page 7-17*, display the screen.

2

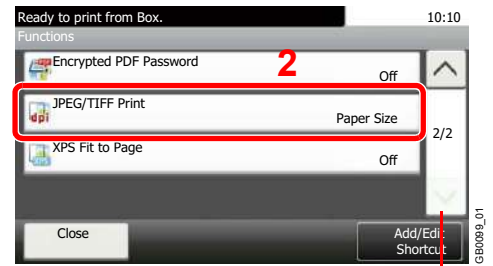
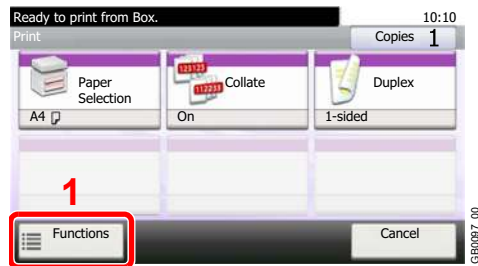

Use [∨] or [∧] to scroll up and down.

2 Select the function.

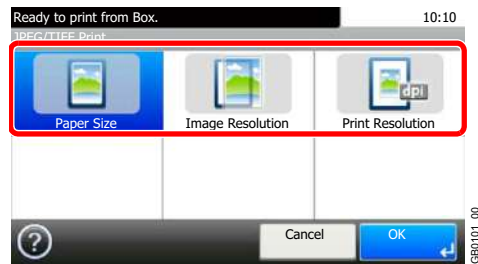

XPS Fit to Page

Reduces or enlarges the image size to fit to the selected paper size when printing XPS files.

1 Display the screen.

1 Referring to *Printing Documents Stored in Removable USB Memory on page 7-17*, display the screen.

2

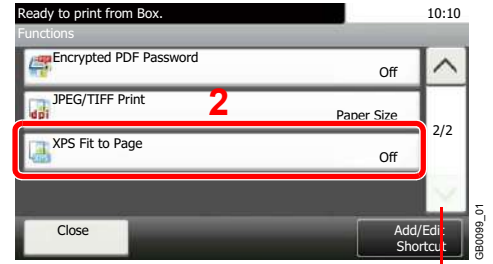
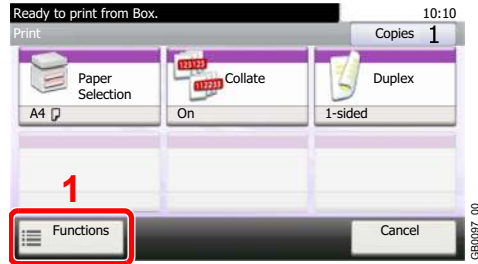

Use [∨] or [∧] to scroll up and down.

2 Select the function.

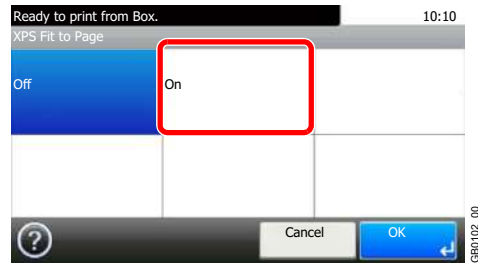

Storing Size

Select size of image to be stored.

Same as Original Size	Store an image the same size as the original.
Metric	Select from A4, A5, A6, B5, B6, Folio or 216 × 340 mm.
Inch	Select from Letter, Legal, Statement, Executive or Oficio II.
Others	Select from 16K, ISO B5, Envelope #10, Envelope #9, Envelope #6, Envelope Monarch, Envelope DL, Envelope C5, Hagaki, Oufukuhagaki, Youkei 4 or Youkei 2.

Relationship between Original Size, Storing Size, and Zoom

Original Size (page 3-35), Storing Size, and Zoom (page 3-49) are related to each other. Refer to the following table.

Original Size and the size you wish to store as are	the same	different
Original Size	Specify as necessary	Specify as necessary
Storing Size	Select [Same as Original]	Select the required size
Zoom	Select [100%] (or [Auto])	Select [Auto]

NOTE
When you select Storing Size that is different from Original Size, and select the Zoom [100%], you can store the image as the actual size (No Zoom).

1 Display the screen.

1 Referring to *Saving Documents to USB Memory (Scan to USB)* on page 7-20, display the screen.

2

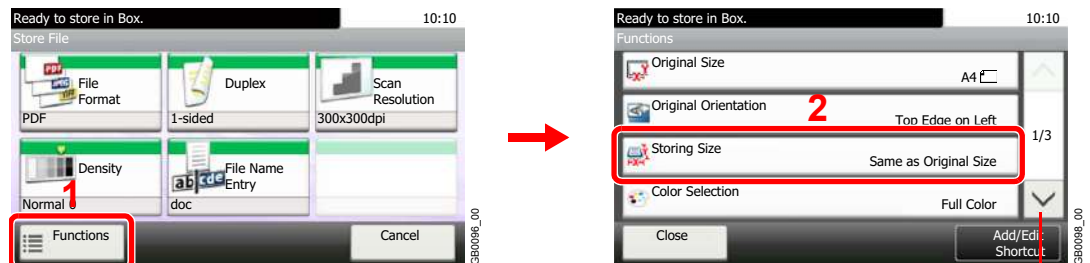

Use [∨] or [∧] to scroll up and down.

2 Select the storing size.

[Same as Original Size]

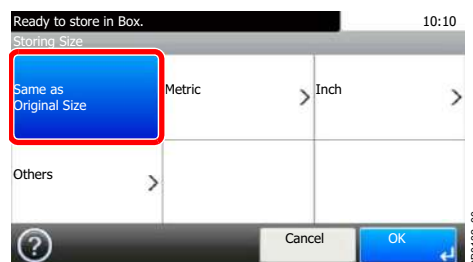

[Metric], [Inch] or [Others]

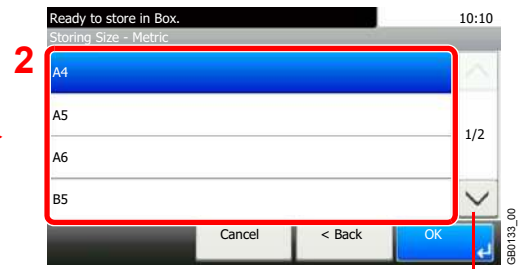
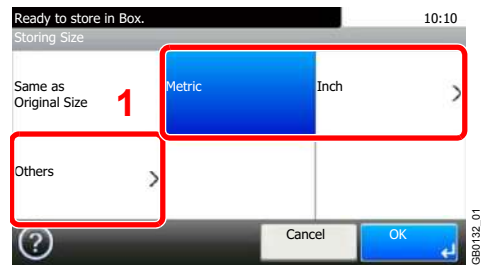

Use [∨] or [^] to scroll up and down.

Select the desired size.

8 Status / Job Cancel

This chapter explains the following topics:

Checking Job Status	8-2
Details of the Status Screens	8-3
Checking Job History	8-7
Sending the Log History	8-8
Setting the Destination	8-9
Automatic Log History Transmission	8-10
Manual Log History Transmission	8-10
Setting E-mail Subject	8-11
Personal information in the job log	8-12
Check of Device Status	8-13
Checking the Remaining Amount of Toner and Paper	8-16

Checking Job Status

Check the status of jobs being processed or waiting to be printed.

Available Status Screens

The processing and waiting statuses of jobs are displayed as a list on the touch panel in four different screens - Printing Jobs, Sending Jobs, Storing Jobs, and Scheduled Jobs. The following job statuses are available.

Print Job Status	Copy Printer Printing from Document Box FAX reception	E-mail reception Job Report /List Printing data from removable memory Application
Send Job Status	FAX transmission Folder (SMB/FTP) transmission E-mail	Application Mixed (Multiple destination)
Store Job Status	Scan FAX	Printer
Scheduled Job	Sending Job FAX using Delayed transmission	



NOTE

FAX functions are available only on products with the fax function installed.

1 Display the screen.

Status/
Job Cancel

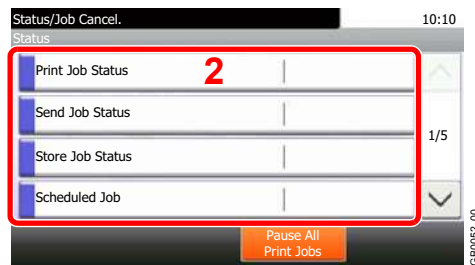

Press either of [Print Job Status], [Send Job Status], [Store Job Status] or [Scheduled Job] to check the status.

2 Check the status.

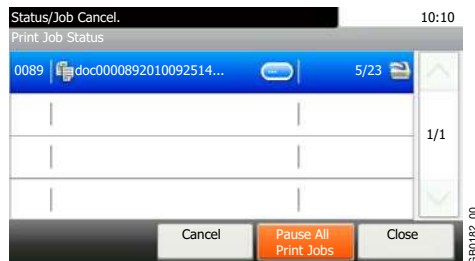

Refer to *Print Job Status Screen* on page 8-3, *Send Job Status screen* on page 8-4, *Store Job Status screen* on page 8-5, and *Scheduled Job screen* on page 8-6.

Details of the Status Screens

Print Job Status Screen

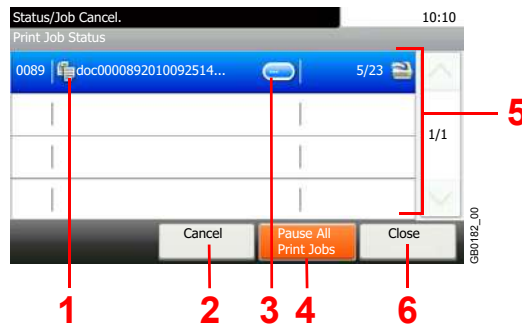

No.	Item/Key	Detail
1	—	<p>Icons that indicate the job type</p> <ul style="list-style-type: none"> Copy job Printer job Job from Document Box FAX reception E-mail reception Report/List Data from removable memory Application
2	[Cancel]	Select the job to be canceled from the list, and press this key.
3	[...]	Press [...] for the job for which you wish to display detailed information.
4	[Pause All Print Jobs]	Pauses all the printing jobs. By pressing this key again, the printing jobs will be resumed.
5	—	<p>Status of job</p> <ul style="list-style-type: none"> Printing Printing (priority override) Print Waiting Print Waiting (priority override) Pausing print job or error Canceling the job The status before starting to print. The status before starting to print. (priority override) Printing has been suspended due to priority override.
6	[Close]	Closes the Print Job Status screen.



NOTE

FAX functions are available only on products with the fax function installed.

Send Job Status screen

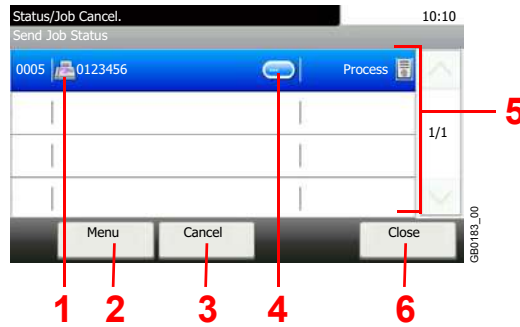

No.	Display/Key	Detail
1	—	<p>Icons that indicate the job type</p> <ul style="list-style-type: none"> Sending Job FAX Sending Job Folder (SMB/FTP) Sending Job E-mail Sending Job Application Sending Job Mixed (Multiple)
2	[Menu]	<p>Pressing this key displays [Priority Override]. This function allows you to give a particular fax job priority.</p> <p>Select the fax job you wish to send immediately and then press [Menu], followed by [Priority Override].</p>
3	[Cancel]	<p>Select the job you want to cancel from the list, and press this key.</p>
4	[...]	<p>Press [...] for the job for which you wish to display detailed information.</p>
5	—	<p>Status of job</p> <ul style="list-style-type: none"> Sending Sending Waiting A job for which immediate transmission was specified is waiting for transmission to start. Pausing the job or error Canceling the job The status before starting sending such as during scanning originals
6	[Close]	<p>Closes the Send Job Status screen.</p>



NOTE

FAX functions are available only on products with the fax function installed.

Store Job Status screen

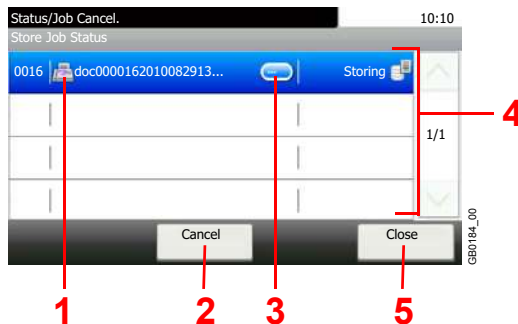

No.	Display/Key	Details
1	—	Icons that indicate the job type Storing Job Scan Storing Job Printer Storing Job FAX
2	[Cancel]	Select the job you want to cancel from the list, and press this key.
3	[...]	Press [...] for the job for which you wish to display detailed information.
4	—	Status of job Storing Data Pausing the job or error Canceling the job The status before starting to save such as during scanning originals
5	[Close]	Closes the Store Job Status screen.





NOTE

FAX functions are available only on products with the fax function installed.

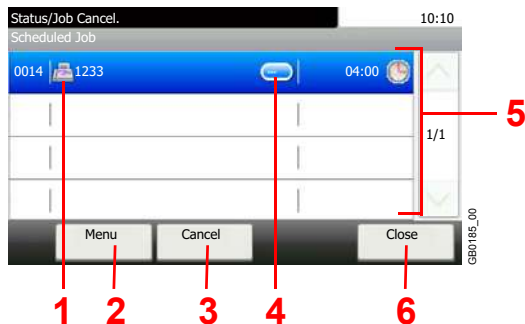
Scheduled Job screen



No.	Display/Key	Details
1	—	Icons that indicate the job type  Sending Job FAX
2	[Menu]	Pressing this key displays [Start Now]. Select the job you wish to send immediately and then press [Menu], followed by [Start Now].
3	[Cancel]	Select the job you want to cancel from the list, and press this key.
4	[...]	Press [...] for the job for which you wish to display detailed information.
5	—	Status of job  Sending Waiting
6	[Close]	Closes the Scheduled Job screen.



NOTE

FAX functions are available only on products with the fax function installed.

Checking Job History

Check the history of completed jobs.

Available Job History Screens

The job histories are displayed separately in four screens - Printing Jobs, Sending Jobs, Storing Jobs, and FAX Jobs. The following job histories are available.

Print Job Log	Copy Printer FAX reception E-mail reception Printing from Document Box Job Report/List Printing data from removable memory Application	Store Job Log	Scan FAX Printer
Send Job Log	FAX Folder (SMB/FTP) E-mail Application Mixed (Multiple destination)	FAX Job Log	Outgoing FAX Log Incoming FAX Log Outgoing FAX Report Incoming FAX Report

 **NOTE**

FAX functions are available only on products with the fax function installed.

1 Display the screen.

Status/
Job Cancel

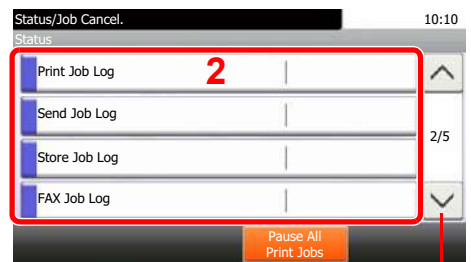

Use [∨] or [∧] to scroll up and down.

Press either of [Print Job Log], [Send Job Log], [Store Job Log], or [FAX Job Log] to check the log.

2 Check the log.

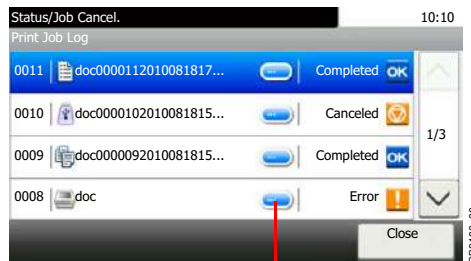

Displays details for individual jobs.

Press [Close] to exit the screen.

 **NOTE**

The job history can be sent by E-mail.



For details, refer to *Sending the Log History on page 8-8*.

Sending the Log History

You can send the log history by e-mail. You can either send it manually as needed or have it sent automatically whenever a set number of jobs is reached.

NOTE
To send the log history by e-mail, select [On] of the SMTP settings on the Command Center RX. Refer to *E-mail settings on page 2-34*.

1 Display the screen.

◆ System Menu / Counter

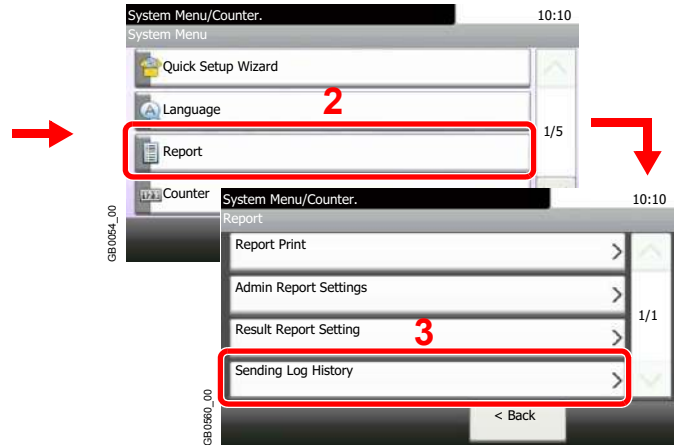
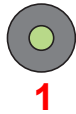

NOTE
If user login administration is enabled, you can only change the settings by logging in with administrator privileges.

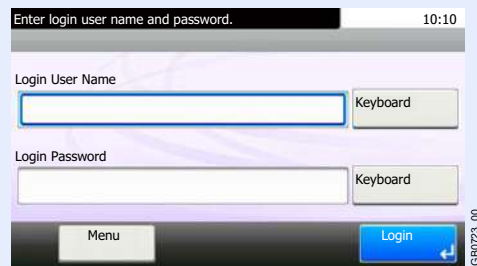

2 Configure the function.



Refer to *Setting the Destination on page 8-9*, *Automatic Log History Transmission on page 8-10*, *Manual Log History Transmission on page 8-10* and *Setting E-mail Subject on page 8-11*.

Setting the Destination

Set the destination to which log histories are sent.

1 Display the screen.

1 Referring to *Sending the Log History* on page 8-8, display the screen.

2

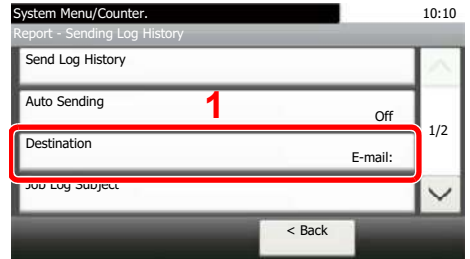

2 Select the destination.

Select from the Address Book.

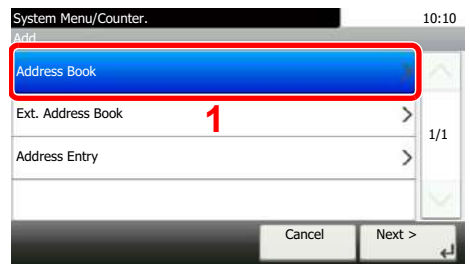

Searches by destination name.

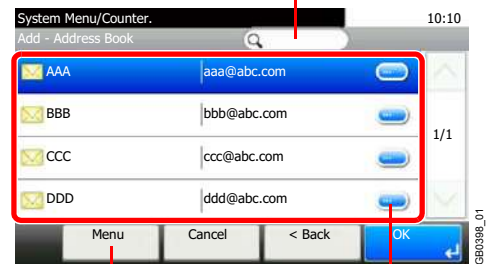

Allows you to search for and sort destinations.

Displays details for individual destinations.

Enter a new e-mail address.

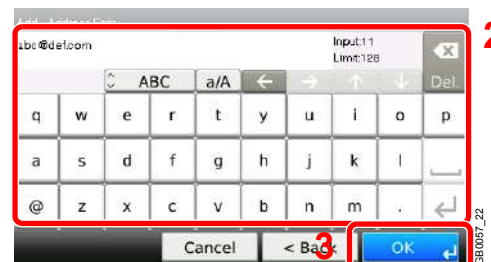
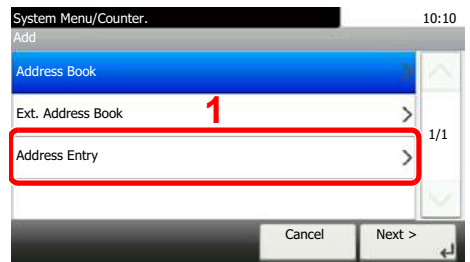

Up to 128 characters can be entered.

 Refer to *Character Entry Method* on page 11-8 for details on entering characters.

3 Accept the destination.

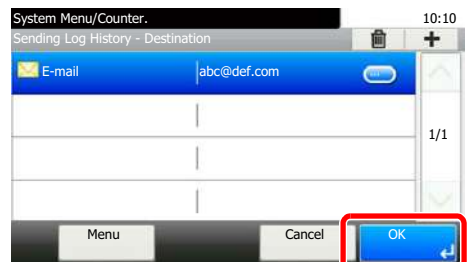

Automatic Log History Transmission

This function automatically sends the log history to the specified destinations whenever a set number of jobs has been logged.

1 Display the screen.

1 Referring to *Sending the Log History* on page 8-8, display the screen.

2

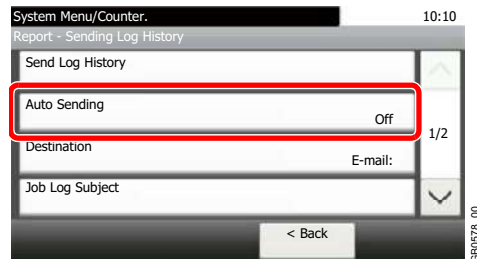

2 Select the function.

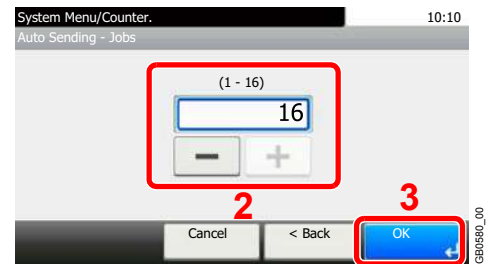
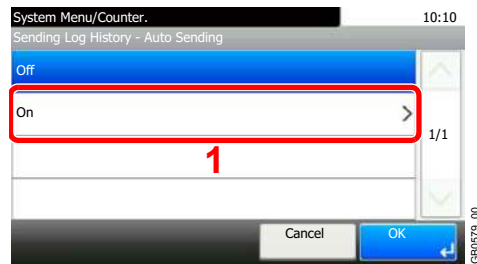

Press [On] and enter the number of jobs in the log history print. You can enter any number between 1 and 16.

Manual Log History Transmission

You can also send the log history to the specified destinations manually.

1 Display the screen.

Referring to *Sending the Log History* on page 8-8, display the screen.

2 Send the log history.

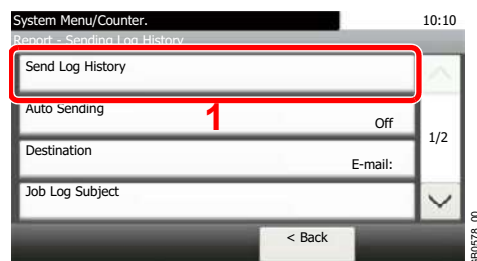

Setting E-mail Subject

Set the subject automatically entered when sending log histories by E-mail.

1 Display the screen.

1 Referring to *Sending the Log History on page 8-8*, display the screen.

2

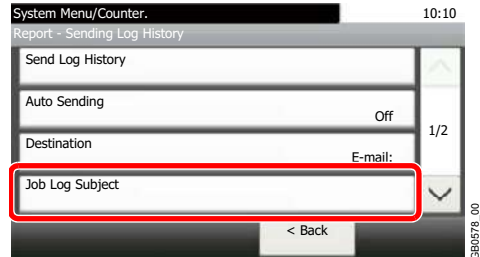

2 Enter an E-mail subject.



Up to 60 characters can be entered.

 Refer to *Character Entry Method on page 11-8* for details on entering characters.

Personal information in the job log

When the job log is sent by e-mail, personal information can be including the job log of the user who logs in.

1 Display the screen.

1 Referring to *Sending the Log History on page 8-8*, display the screen.

2

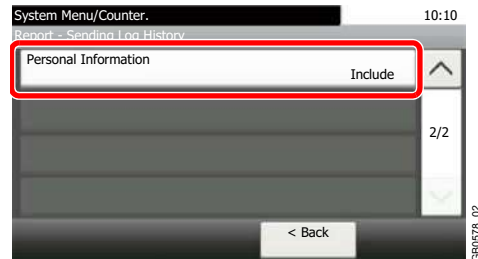

2 Configure the settings.

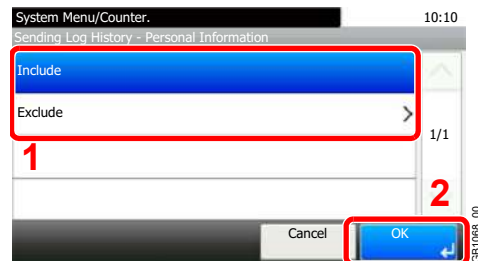

Check of Device Status

Configure the devices/lines installed or connected to this machine or check their status. You can also control devices depending on their status.

1 Display the screen.

Status/
Job Cancel



Use [V] or [^] to scroll up and down.

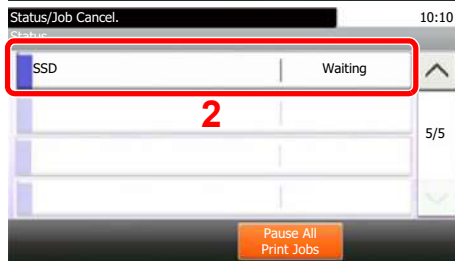
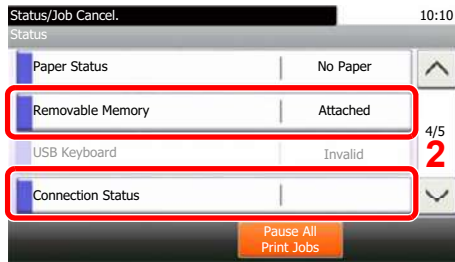

Select the device you wish to check.

2 Check the status.

Scanner



The status of an original scanning in the document processor or the error information (paper jam, opened cover, etc.) is displayed.

Printer



Error information such as paper jam, out of toner, or out of paper, and status such as waiting or printing are displayed.

FAX



- The information such as sending/receiving and dialing is displayed.
- Press [Line Off] to cancel a fax in sending/receiving.

For details, refer to the *FAX Operation Guide*.



NOTE

FAX functions are available only on products with the fax function installed.

Removable Memory

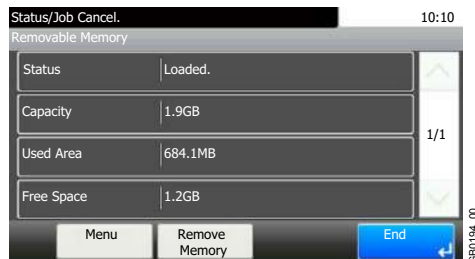

- The usage and capacity of the external media connected to this machine are displayed.
- Press [Menu] and then [Format] to format external media.
- Press [Remove Memory] to safely remove the external media. This operation is the same as that for *Removing USB Memory on page 7-22*.

Connection Status



The network connection status and network name (SSID) appear.

SSD



Information on the optional SSD appears.

Checking the Remaining Amount of Toner and Paper

Check the remaining amount of toner and paper on the touch panel.

1 Display the screen.

Status/
Job Cancel

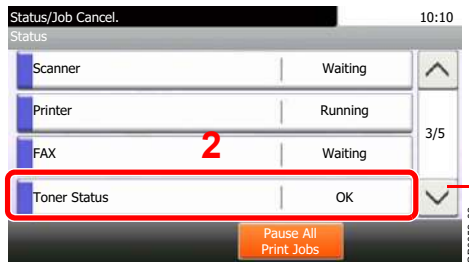

Use [∨] or [∧] to scroll up and down.

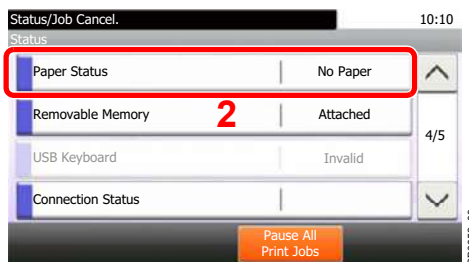

Select the consumable you wish to check.

2 Check the status.

Toner Status

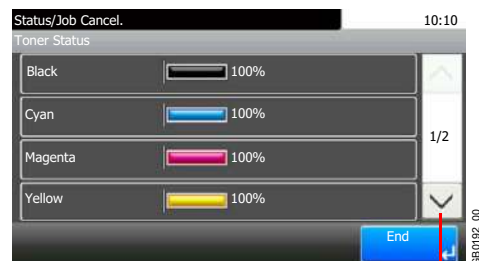

Use [∨] or [∧] to scroll up and down.



You can check the remaining amount of each color toner levels from 100 to 0% (1% increments), and check the status of waste toner box.

Paper Status



You can check the size, orientation, type, and remaining amount of paper in each paper source. The remaining amount of paper is shown by four levels as (), *, *, and () (none). If there is no paper in either cassette, the paper status will be shown as *No Paper*.

* and are displayed only on optional paper feeders (Cassette 2 and 3).

9 Setup, Registration, and User Management

This chapter explains the following topics:

System Menu	9-2
Operation Method	9-2
System Menu Settings	9-3
Language	9-5
Report	9-5
User Property	9-7
Cassette/MP Tray Settings	9-7
Common Settings	9-9
Copy	9-14
Send	9-15
Favorites/Application	9-16
Internet	9-16
Printer	9-17
System/Network	9-19
Date/Timer/Energy Saver	9-27
Adjustment/Maintenance	9-28
Color Registration Procedure	9-30
User Login Administration	9-36
First User Login Administration	9-36
User Login Settings	9-37
Enabling/Disabling User Login Administration	9-38
Adding a User	9-40
Local User Authorization	9-45
My Panel	9-46
Editing and Deleting Users	9-47
ID Card Settings	9-50
Simple Login	9-51
Group Authorization	9-57
Obtain Network User Property	9-61
Job Accounting	9-63
First Job Accounting Setup	9-63
Job Accounting Settings	9-65
Enabling/Disabling Job Accounting	9-66
Login/Logout	9-67
Job Accounting Access	9-68
Adding an Account	9-69
Editing and Deleting Accounts	9-71
Restricting the Use of the Machine	9-73
Counting the Number of Pages Printed	9-75
Printing an Accounting Report	9-77
Job Accounting Default Setting	9-78
Unknown Login User Name Job	9-79

System Menu

Configure settings related to overall machine operation.

Operation Method

The system menu is operated as follows:

1 Display the screen.

◆ System Menu / Counter



2 Configure the function.

Displays available functions.

Scrolls up and down when the list of values cannot be displayed in its entirety on a single screen.

Displays available functions.

Return to the previous screen.

Selecting a value it to be accepted.

Returns to the original screen without making any changes.

Accepts the settings and exits.



NOTE

In order to change settings that require administrator privileges, you must log in with administrator privileges. Refer to *Adding a User* on page 9-40 for the default login user name and password.

Refer to *System Menu Settings* on the following page and configure as needed.

System Menu Settings

System Menu include;

Item	Description	Reference Page
Quick Setup Wizard	The Quick Setup Wizard configures fax, cassette, network, and Energy Saver settings.	3-29
Language	Select the language displayed on the touch panel.	9-5
Report	Print reports to check the machine settings and status. Default settings for printing the result reports can also be configured.	9-5
Counter	This counts the number of pages printed or scanned.	3-14
User Property	Allows you to view information about logged in users and edit some of that information.	9-7
Cassette/MP Tray Settings	Select paper size and media type for Cassette 1 to 3 and multi purpose tray.	9-7
Common Settings	Configures overall machine operation.	9-9
Default Screen	Select the screen appearing right after start-up (default screen).	9-9
Sound	Set options for buzzer sound during the machine operations.	9-9
Original Settings	Configures settings for originals.	9-9
Paper Settings	Configures settings for paper.	9-10
Function Defaults	<p>Defaults are the values automatically set after the warm-up is completed or the Reset key is pressed.</p> <p>Set the defaults for available settings such as copying and sending. Setting the frequently-used values as defaults makes subsequent jobs easier.</p> <p> IMPORTANT: If you want to enable the changed defaults immediately, move to the function screen and press the Reset key.</p>	9-11
Preset Limit	Restrict the number of copies that can be made at one time.	9-13
Error Handling	Select whether to cancel or continue the job when error has occurred.	9-13
Measurement	Select inch or metric for the unit for paper dimensions.	9-13
Low Toner Alert Level	Set the amount of remaining toner to alert low toner.	9-13
Keyboard Layout	Change the layout of the touch panel keyboard used to enter characters.	9-14
USB Keyboard Type	Select the type of USB keyboard that you want to use.	9-14
Format SSD	Format the optional SSD.	9-14
Display Status/Log	Set the display method of the Status/Log.	9-14
Copy	Configures settings for copying functions.	9-14
Send	Configures settings for sending functions.	9-15
Document Box	Configures settings related to the Job Box, Custom Box and Sub Address Box. For details on Job Box, refer to <i>Printing on page 5-1</i> , for details on Custom Box, refer to <i>Using a Custom Box on page 7-3</i> and for details on Sub Address Box, refer to the <i>Fax Operation Guide</i> .	—
FAX	Configures settings for fax functions. Refer to the <i>Fax Operation Guide</i> .	—
Favorites/Application	You can install and use applications that will make your day-to-day use of this machine more efficient.	9-16

Item	Description	Reference Page
Internet	This procedure sets up the Internet browser application.	9-16
Address Book/One Touch	Configures Address Book and One Touch Key settings. For details on Address Book, refer to <i>Registering Destinations in the Address Book on page 6-24</i> and for details on One Touch Key, refer to <i>Adding a Destination on One Touch Key on page 6-33</i> .	—
User Login/Job Accounting	Configures settings related to machine management. For details on User Login, refer to <i>User Login Administration on page 9-36</i> , and for details on Job Accounting, refer to <i>Job Accounting on page 9-63</i> .	—
Printer	Printing from computers, settings are generally made on the application software screen. However, the following settings are available for configuring the defaults to customize the machine.	9-17
System/Network	Configures machine system settings.	9-19
Network	Configures network settings.	9-19
Optional Network	Configure settings for the optional Network Interface Kit or Wireless Interface Kit.	9-24
Network Interface (Send)	Specify the network interface card to be used for send function and connecting to external address book.	9-25
Interface Block Setting	This allows you to protect this machine by blocking the interface with external devices such as USB host or optional interfaces.	9-26
Security Level	The Security Level setting is primarily a menu option used by service personnel for maintenance work. There is no need for customers to use this menu.	—
Restart	Restart the CPU without turning the main power switch off. Use this to deal with any unstable operation by the machine. (Same as the computer restart.)	—
RAM Disk Setting	A RAM disk can be created and its size can be set. Creating a RAM disk makes it possible to print from a Job Box.	9-26
Optional Memory	When optional memory is installed, select the memory allocation scheme based on the application in which you are using the equipment.	9-26
Optional Function	You can use the optional applications installed on this machine.	11-6
Date/Timer/Energy Saver	Configures settings related to the date and time.	9-27
Adjustment/Maintenance	Adjust printing quality and conduct machine maintenance.	9-28

Language

Item	Description
Language	Select the language displayed on the touch panel. <i>Value:</i> English, Deutsch, Français, Español, Italiano, Nederlands, Русский, Português

Report

Print reports to check the machine settings and status. Default settings for printing the result reports can also be configured.

Report Print

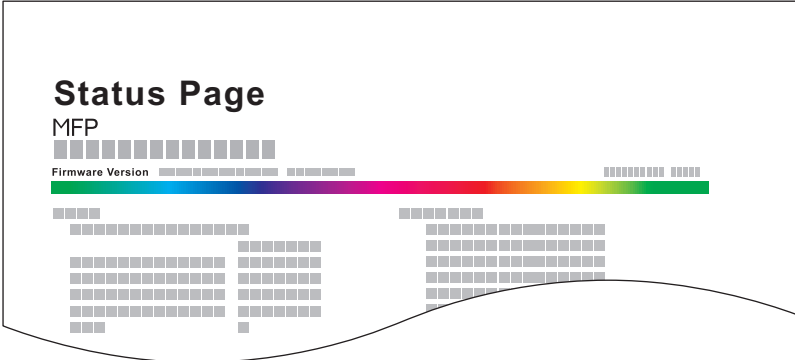
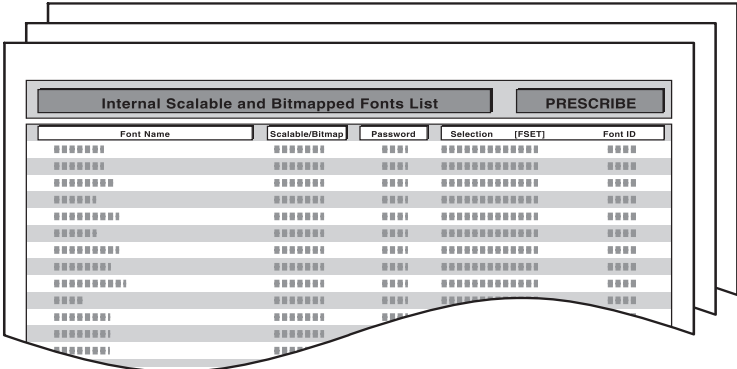
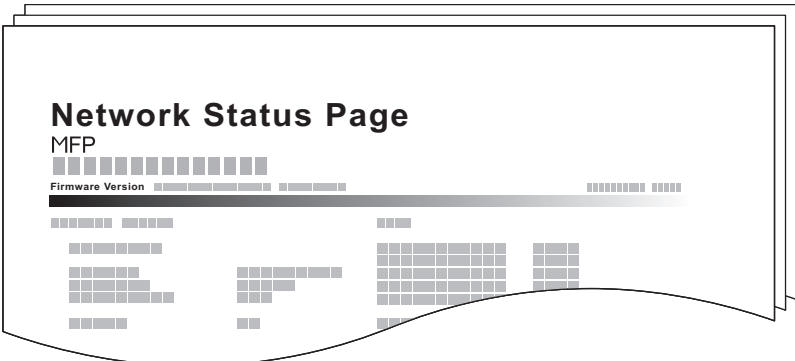
Item	Description
Status Page	<p>Prints the status page, allowing you to check the information including current settings and optional equipment installed.</p> 
Font List	<p>Prints the font list, allowing you to check the font samples installed in the machine.</p> 
Network Status	<p>Prints the network status, allowing you to check the information including network address and protocol.</p> 

Item	Description
Service Status	Prints the service status. More detailed information is available than on the Status Page. Service personnel usually print the service status pages for maintenance purpose.
Accounting Report	<p>Prints the accounting report, allowing you to check the accounts that have been registered on the machine.</p> <div style="border: 1px solid black; padding: 10px; margin: 10px 0;"> <p style="text-align: center;">ACCOUNT.REPORT</p> <p>MFP</p> <p>Firmware Version</p> </div> <p> NOTE: You can print the accounting report by logging in with administrator privileges. Refer to <i>Adding a User on page 9-40</i> for the default login user name and password.</p>

Result Report Settings

Item	Description
Send Result Report	Automatically print a report of transmission result when a transmission is complete.
E-mail/Folder	Automatically print a report of transmission result when E-mail or SMB/FTP transmission is complete. <i>Value:</i> Off, On, Error Only
FAX*	For details, refer to the <i>FAX Operation Guide</i> .
Canceled before Sending	Print a send result report if the job is canceled before being sent. <i>Value:</i> Off, On
Recipient Format	Select the Recipient Format for the send result report. <i>Value:</i> Name or Destination, Name and Destination
Job Finish Notice Setting	Attaches sent images to job finish notices. <i>Value:</i> Do Not Attach Image, Attach Image

* FAX functions available only on products with the fax function installed.

Sending Log History



You can send the log history by e-mail. You can either send it manually as needed or have it sent automatically whenever a set number of jobs is reached.

 Refer to *Sending the Log History on page 8-8*.

User Property

Allows you to view information about logged in users and edit some of that information.



 For details on User Login, refer to *User Login Administration on page 9-36*.

Item	Description
User Name	Changes the name shown on the user list. Up to 32 characters can be entered.
Login User Name	Displays the login user name that is entered at login.
Login Password	Changes the password that is entered at login. Up to 64 characters can be entered.
Access Level	Displays the user's access level.
Account Name	Displays the account to which the user belongs.
E-mail Address	Changes the user's e-mail address. Up to 128 characters can be entered.
ID Card Info.	Displays the ID card information of the logged in user.  NOTE: This function is displayed when the optional ID Card Authentication Kit is activated.  Refer to <i>Card Authentication Kit on page 11-4</i> .
Simple Login	When simple login is enabled, changes associated settings.
My Panel	Registers settings for individual users. Settings registered here can be applied simply by logging in. Network users are not displayed.
Group Name	When group authorization is enabled, displays the name shown in the group list.
Group ID	When group authorization is enabled, displays the ID shown in the group list.



Cassette/MP Tray Settings

Select paper size and media type for Cassette 1 to 3 and multi purpose tray.



Cassette1

Item	Description
Paper Size	Set the paper size to load in Cassette 1 Value Metric: Select from A4, A5, A6, B5 or Folio, 216 × 340 mm Inch: Select from Letter, Legal, Statement, Executive or Oficio II. Others: Select from 16K, ISO B5, Envelope C5 or Custom.  NOTE: [Paper Size] is only displayed when the Cassette 1 size dial is set to Other.  For instructions on how to specify the custom paper size, refer to <i>Custom Paper Size on page 9-10</i> .
Media Type	Set the media type to load in Cassette 1. Value: Plain (105 g/m ² or less), Rough, Recycled, Preprinted, Bond, Color, Prepunched, Letterhead, Thick (106 g/m ² and more), High Quality, Custom 1-8  NOTE: To print on preprinted or prepunched paper or on letterhead, refer to <i>Special Paper Action on page 9-10</i> . To change to a media type other than [Plain], refer to <i>Media Type Setting on page 9-10</i> . Refer to <i>Media Type Setting on page 9-10</i> for selecting Custom 1- 8.

Cassette2 to 3

Item	Description
Paper Size	Set the paper size to load in optional paper feeders (Cassette 2 and 3). Value Metric: Select from A4, A5, B5, Folio or 216 × 340 mm Inch: Select from Letter, Legal, Statement, Executive or Oficio II. Others: Select from 16K, ISO B5, Envelope #10, Envelope #9, Envelope #6, Envelope Monarch, Envelope DL, Envelope C5, Oufukuhagaki, Youkei 4, Youkei 2 or Custom.  NOTE: [Paper Size] is only displayed when the size dial on the cassette is set to Other. For instructions on how to specify the custom paper size, refer to <i>Custom Paper Size on page 9-10</i> .
Media Type	Set the media type to load in optional paper feeders (Cassette 2 and 3). Value: Plain (105 g/m ² or less), Rough, Labels, Recycled, Preprinted, Bond, Cardstock, Color, Prepunched, Letterhead, Envelope, Thick (106 g/m ² and more), Coated, High Quality, Custom 1-8  NOTE: [Labels], [Cardstock], [Envelope] and [Coated] are shown when the optional paper feeder (multi purpose) is installed. To print on preprinted or prepunched paper or on letterhead, refer to <i>Special Paper Action on page 9-10</i> . To change to a media type other than [Plain], refer to <i>Media Type Setting on page 9-10</i> . Refer to <i>Media Type Setting on page 9-10</i> for selecting Custom 1- 8.

Multi Purpose Tray

Item	Description
Paper Size	Set the paper size for multi-purpose tray. Value Metric: Select from A4, A5, A6, B5, B6, Folio or 216 × 340 mm. Inch: Select from Letter, Legal, Statement, Executive or Oficio II. Others: Select from 16K, ISO B5, Envelope #10, Envelope #9, Envelope #6, Envelope Monarch, Envelope DL, Envelope C5, Hagaki, Oufukuhagaki, Youkei 4, Youkei 2 or Custom.  NOTE: For instructions on how to specify the custom paper size, refer to <i>Custom Paper Size on page 9-10</i> .
Media Type	Set the media type for multi-purpose tray. Value: Plain (105 g/m ² or less), Transparency, Rough, Vellum (64 g/m ² or less), Labels, Recycled, Preprinted, Bond, Cardstock, Color, Prepunched, Letterhead, Envelope, Thick (106 g/m ² and more), Coated, High Quality, Custom 1-8  NOTE: To print on preprinted or prepunched paper or on letterhead, refer to <i>Special Paper Action on page 9-10</i> . Refer to <i>Media Type Setting on page 9-10</i> for selecting Custom 1- 8.

Common Settings

Configures overall machine operation.

Default Screen

Item	Description
Default Screen	Select the screen appearing right after start-up (default screen). Value: Copy, Send, FAX, Document Box, Favorites/Application, Status







Sound

Item	Description
Buzzer	Set options for buzzer sound during the machine operations.
Volume	Set the buzzer volume level. Value: 0 (Mute), 1 (Minimum) to 5 (Maximum)
Key Confirmation	Emit a sound when the operation panel and touch panel keys are pressed. Value: Off, On
Job Finish	Emit a sound when a print job is normally completed. Value: Off, On, FAX Reception Only  NOTE: FAX functions are available only on products with the fax function installed.
Ready	Emit a sound when the warm-up is completed. Value: Off, On
Warning	Emit a sound when errors occur. Value: Off, On
Key Confirmation (USB Keyboard)	Emit a sound when a key on the optional USB keyboard is pressed. Value: Off, On

Original Settings

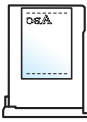
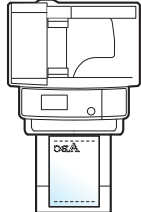
Item	Description
Custom Original Size	Set up frequently-used custom original size. The custom size option is displayed on the screen when selecting original size. Value Inch models – X: 1.97 to 14.02" (in 0.01" increments), Y: 1.97 to 8.50" (in 0.01" increments) Metric models – X: 50 to 356 mm (in 1 mm increments), Y: 50 to 216 mm (in 1 mm increments)
Default Original Size	In the screen for setting the original size, select the paper size to be used as the default value. Value Metric: Select from A4, A5, A6, B5, B6, Folio or 216 × 340 mm. inch: Select from Letter, Legal, Statement, Executive or Oficio II. others: 16K

Paper Settings

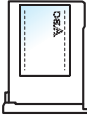
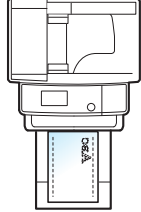
Item	Description
Custom Paper Size	<p>Set up frequently-used custom paper size. The custom size option is displayed on the screen when selecting paper size.</p> <p>Value</p> <p>Inch models Cassette 1 size: X 4.13 to 8.50", Y 5.83 to 14.02" Cassette 2 (to 3) size: X 3.62 to 8.50", Y 6.38 to 14.02" MP tray size: X 2.76 to 8.50", Y 5.83 to 14.02"</p> <p>Metric models Cassette 1 size: X 105 to 216 mm, Y 148 to 356 mm Cassette 2 (to 3) size: X 92 to 216 mm, Y 162 to 356 mm MP tray size: X 70 to 216 mm, Y 148 to 356 mm</p>
Media Type Setting	<p>Select weight for each media type.</p> <p>For Custom 1-8, settings for duplex printing and media type name can be changed.</p> <p>For details, refer to <i>Media Type Setting on page 9-11</i>.</p>
Default Paper Source	<p>Select the default paper source from Cassette 1-3 and multi purpose tray.</p> <p>Value: Cassette 1 to 3, Multi Purpose Tray</p>
Paper Selection	<p>Set the default paper selection.</p> <p>Value</p> <p>Auto: Automatically select the cassette containing paper in the same size as originals.</p> <p>Default Paper Source: Select paper source set by <i>Default Paper Source</i>.</p>
Media for Auto (Color)	<p>Select a default media type for auto paper selection when [Auto] is selected of Paper Selection. If Plain is selected, the paper source with plain paper loaded in the specific size is selected.</p>
Media for Auto (B&W)	<p>Select [All Media Types] for the paper source with any kind of paper loaded in the specific size.</p> <p>Value: All Media Types, Plain, Transparency, Rough, Vellum, Labels, Recycled, Preprinted, Bond, Cardstock, Color, Prepunched, Letterhead, Envelope, Thick, Coated, High Quality, Custom 1 to 8</p>
Special Paper Action	<p>When printing on Prepunched, Preprint, and Letterhead, punch-holes might not be aligned or the print direction might be upside-down depending on how originals are set and the combination of copying functions. In such a case, select [Adjust Print Direction] to adjust the print direction. When paper orientation is not important, select [Speed Priority].</p> <p>Example: copying on Letterhead</p> <div style="display: flex; justify-content: space-around; align-items: flex-end;"> <div style="text-align: center;">  Original </div> <div style="text-align: center;">  Paper </div> <div style="text-align: center;">  Finished </div> <div style="text-align: center;">  Cassette </div> <div style="text-align: center;">  Multi Purpose Tray </div> </div> <div style="display: flex; justify-content: space-around; align-items: flex-end; margin-top: 20px;"> <div style="text-align: center;">  Original </div> <div style="text-align: center;">  Paper </div> <div style="text-align: center;">  Finished </div> <div style="text-align: center;">  Cassette </div> <div style="text-align: center;">  Multi Purpose Tray </div> </div> <p>Value: Adjust Print Direction, Speed Priority</p>

Media Type Setting

The following media type and paper weight combinations are available.

Paper Weight	Weight (g/m ²)	Paper Weight	Weight (g/m ²)
Light	63 g/m ² or less	Heavy 1	106 g/m ² to 135 g/m ²
Normal 1	64 g/m ² to 75 g/m ²	Heavy 2	136 g/m ² to 163 g/m ²
Normal 2	76 g/m ² to 90 g/m ²	Heavy 3	164 g/m ² and more
Normal 3	91 g/m ² to 105 g/m ²	Extra Heavy	Transparencies

Each media type's default weight is indicated.



Media Type	Default	Media Type	Default
Plain	Normal 2	Color	Normal 2
Transparency	Extra Heavy	Prepunched	Normal 2
Rough	Normal 3	Letterhead	Normal 2
Vellum	Light	Envelope	Heavy 2
Labels	Heavy 1	Thick	Heavy 2
Recycled	Normal 2	Coated	Heavy 1
Preprinted	Normal 2	High Quality	Normal 3
Bond	Normal 3	Custom 1 - 8	Normal 2
Cardstock	Heavy 1		

For Custom 1-8, settings for duplex printing and media type name can be changed.

Item		Description
Custom 1-8	Duplex	Select the setting for duplex. Value: Prohibit, Permit
	Name	Change names for Custom 1-8. Names should be not more than 16 characters. Selecting media type at multi purpose tray, the name after change will be displayed.

Function Defaults

Item	Description
File Format	Select the default type of the files to be sent. Value: PDF, High Comp. PDF, TIFF, JPEG, XPS
Original Orientation	Set the original orientation defaults. Value: Top Edge on Top, Top Edge on Left
Collate	Set the defaults for Collate. Value: Off, On
File Separation	Select the default file separation setting. Value: Off, Each Page
Scan Resolution	Select the default scanning resolution. Value: 600 × 600dpi, 400 × 400dpi Ultra Fine, 300 × 300dpi, 200 × 400dpi Super Fine, 200 × 200dpi Fine, 200 × 100dpi Normal
Color Selection (Copy)	Select the default copying color mode setting. Value: Auto Color, Full Color, Black & White

Item	Description
Color Select.(Send/Store)	Select the default color mode for scanning documents. Value: Auto (Color/Gray), Auto (Color/B & W), Full Color, Grayscale, Black & White
Original Image(Copy)	Set the default original document type for copying. Value: Text+Photo, Photo, Text, Graphic/Map, Printer Output
Original Image(Send/Store)	Set the default original document type for sending/storing. Value: Text+Photo, Photo, Text, Text (for OCR)
Background Density Adj. (Copy)	Set the default Backgrnd Density (Copy). Value: Off, Auto, Manual (Darker 5)
Background Density Adj. (Send/Store)	Set the default Backgrnd Density (Copy). Value: Off, Auto, Manual (Darker 5)
EcoPrint	Select the EcoPrint default. Value: Off, On
FAX TX Resolution	For details, refer to the <i>FAX Operation Guide</i> .  NOTE: FAX functions are available only on products with the fax function installed.
Zoom	Select the enlarged/reduced default when paper size/sending size changed after the originals set. Value: 100%, Auto
Continuous Scan (Except FAX)	Set the continuous scan defaults. Value: Off, On
Continuous Scan (FAX)	For details, refer to the <i>FAX Operation Guide</i> .  NOTE: FAX functions are available only on products with the fax function installed.
File Name Entry	Set an automatically entered name (default) for jobs. Additional information such as Date and Time and Job No. can also be set. Value File Name: Up to 32 characters can be entered. Additional Info: None, Date and Time, Job No., Job No. & Date and Time, Date and Time & Job No.
E-mail Subject/Body	Set the subject and body automatically entered (default subject and body) when sending the scanned originals by E-mail. Value Subject: Up to 60 characters can be entered. Body: Up to 500 characters can be entered.
FTP Encrypted TX	Set the default value for document encryption during transmission. Value: Off, On  NOTE: This setting is displayed when the secure protocol [SSL] setting is [On].
JPEG/TIFF Print	Select the image size (resolution) when printing JPEG or TIFF file. Value: Paper Size, Image Resolution, Print Resolution
XPS Fit to Page	Set the default value for the XPS fit to page function. Value: Off, On

Item	Description
Detail Settings	—
Image Quality	Set the default value for the image quality adjustment range when selecting the file format with which to send and store images. Value: 1 Low (High Comp.), 2, 3, 4, 5 High (Low Comp.)
PDF/A	Set the default value for PDF/A when selecting the file format with which to send and store images. Value: Off, PDF/A-1a, PDF/A-1b
High Comp. PDF	Set the default value for high compressed PDF when selecting the file format with which to send and store images. Value: Compression Ratio Priority, Standard, Quality Priority

* If you want to enable the changed defaults immediately, move to the function screen and press the **Reset** key.

Preset Limit

Item	Description
Preset Limit	Restrict the number of copies that can be made at one time. Value: 1 to 999 copies.

Error Handling

Item	Description
Duplexing Error	Select what to do when duplex printing is not possible for the selected paper size and media type. Value 1-sided: Printed in 1-sided Display Error: Error message to cancel printing is displayed.
Paper Mismatch Error	Select what to do when the selected paper size or type does not match paper size or type loaded in the specified paper source while printing from the computer by specifying the cassette or multi-purpose tray. Value Ignore: The setting is ignored and the job is printed. Display Error: Error message to cancel printing is displayed.

Measurement

Item	Description
Measurement	Select inch or metric for the unit for paper dimensions. Value: mm, Inch

Low Toner Alert Level

Item	Description
Low Toner Alert Level	Set the amount of remaining toner to alert low toner. Value: Off, On  NOTE: Selecting [Off] alerts you low toner when the amount of remaining toner becomes 5%. If [On] is selected, set the amount of remaining toner to alert. The setting range is 5 to 100% (in 1% increments).

Keyboard Layout

Item	Description
Keyboard Layout	Change the layout of the touch panel keyboard used to enter characters. Value: QWERTY, QWERTZ, AZERTY

USB Keyboard Type

Item	Description
USB Keyboard Type	Select the type of USB keyboard that you want to use. Value: US-English, US-English with Euro

Format SSD

Item	Description
Format SSD	Format the optional SSD.

Display Status/Log

Item	Description
Display Status/Log	Set the display method of the Status/Log.
Display Jobs Detail Status	Value: Show All, My Jobs Only, Hide All
Display Jobs Log	Value: Show All, My Jobs Only, Hide All
Display FAX Log*	Value: Show All, Hide All

* ECOSYS M6526cidn only.

Copy

Configures settings for copying functions.

Item	Description
Auto Paper Selection	If [Auto] is selected for Paper Selection, set the paper size selection method when the zoom changes.* Value Most Suitable Size: Select paper based on the current zoom and the size of the original. Same as Original Size: Select paper that matches the size of the original, regardless the zoom.
Auto % Priority	When a paper source of different size from the original is selected, select whether automatic zoom (reduce/zoom) is performed.* Value: Off, On
Reserve Next Priority	Specify whether the default screen appears when a subsequent copy job is reserved while printing is in progress. To have the default screen appear, select [On]. Value: Off, On
DP Read Action	You can set whether priority is given to speed or image quality when scanning an original on the document processor. Value: Speed Priority, Quality Priority

* If you want to enable the changed defaults immediately, move to the function screen and press the **Reset** key.

Send

Configures settings for sending functions.

Item	Description
Dest. Check before Send	When performing sending jobs, display the confirmation screen of destinations after pressing the Start key. Value: Off, On
Entry Check for New Dest.	When adding new destination, display the entry check screen to check the entered destination. Value: Off, On
Send and Forward	Set whether to send the original to another destination and store it when sending images.
Forward	Set the rule to send the original. Multiple rules can be selected. Value Forward: Off, On Rule: FAX, E-mail, Folder (SMB), Folder (FTP)  NOTE: FAX functions are available only on products with the fax function installed.
Destination	Set the destination to use when storing originals. Select the destination using either of the following methods: <ul style="list-style-type: none"> • Address Book • Ext. Address Book • Address Entry (E-mail) • Address Entry (Folder)
Color TIFF Compression	Select the compression method for TIFF images handled on this machine. Value: TIFF V6, TTN2
Default Screen	Use this procedure to set the default screen displayed when you press the Send key. Value: Destination, Address Book, Ext Address Book, One Touch

Favorites/Application

You can install and use applications that will make your day-to-day use of this machine more efficient. Please contact your dealer or service representative information on applications.

Item		Description
Default Screen		Use this procedure to set the default screen displayed when you press the Favorites/Application key. Value: Favorites, Application, Application 1 - 5 (applications being used)
Application		You can install, activate, deactivate, and delete applications. A list of installed applications is shown. You can view detailed information on the selected application by pressing [Detail].
Menu	Add	You can install new applications. You can view detailed information on the selected application by pressing [Detail].  NOTE: To install the applications, insert the USB memory containing the application to be installed into the USB Port. If <i>Removable Memory is recognized. Displaying files.</i> appears, press [No]. To remove the USB memory, press [Remove Memory] and wait until the <i>Removable Memory can be safely removed</i> message appears. Then remove the USB memory.
	Activate	Activates the application selected on the list. Enter the license key as necessary.
	Deactivate	Deactivates the application selected on the list.
	Print Report	Prints information on the installed applications. The Application Name, ID (Application ID), Version, and other information can be checked.
	Delete	Deletes the application selected on the list.

Internet

This procedure sets up the Internet browser application.

Item		Description
Proxy		Specify the proxy settings. Value: Off, On
Menu	Use Same Proxy	Set whether or not the same proxy server is used for all protocols. If the same proxy server is not used, select [Off]. Value: Off, On
	HTTP Proxy Server	Set a proxy server (HTTP). Value: (Enter the proxy address and port number.)
	HTTPS Proxy Server	Set a proxy server (HTTPS). This setup is available when [Use Same Proxy] is [Off]. Value: (Enter the proxy address and port number.)
	No Proxy Domains	Set domains for which no proxy is used. Value: (Enter the domain name.)

Printer

Printing from computers, settings are generally made on the application software screen. However, the following settings are available for configuring the defaults to customize the machine.

Item	Description
Emulation	Select the emulation for operating this machine by commands oriented to other types of printers. Value: PCL6, KPDL, KPDL (Auto)
KPDL Error Report	When an error has occurred during printing in KPDL emulation mode, set whether or not the error report is output. Value: Off, On
Color Setting	You can choose whether status reports are printed in color or black and white. Value: Color, Black & White
EcoPrint	EcoPrint conserves toner when printing. This is recommended for test copies where faded printing is not a problem. Value: Off, On
Override A4/Letter	Select whether to treat A4 size and Letter, which are similar in size, as the same size when printing. Value: Off: A4 and Letter are not regarded as the same in size. On: A4 and Letter are regarded as the same in size. The machine will use whichever size is in the paper source.
Duplex	Select binding orientation for duplex mode. Value: 1-sided, 2-sided Bind LongEdge, 2-sided Bind ShortEdge
Copies	Set the default number of copies, from 1 to 999. Value: 1 to 999 copies
Orientation	Set the default orientation, [Portrait] or [Landscape]. Value: Portrait, Landscape
Wide A4	Turn this to on to increase the maximum number of characters that can be printed in a line for an A4 page (78 characters at 10 pitch) and Letter size page (80 characters at 10 pitch). This setting is only effective in PCL 6 emulation. Value: Off, On
Form Feed TimeOut	Receiving print data from the computer, the machine may sometimes wait if there is no information signaling that the last page does not have any more data to be printed. When the preset timeout passes, the machine automatically prints paper. The options are between 5 and 495 seconds. Value: 5 to 495 seconds
LF Action	Set the line feed action when the machine receives the line feed code (character code 0AH). Value: LF Only, LF and CR, Ignore LF
CR Action	Set the character return action when the machine receives the character return code (character code 0DH). Value: CR Only, LF and CR, Ignore CR
Job Name	Set whether the job name set in the printer driver is displayed. Value: Off, On  NOTE: When selecting [On], select the job name to be displayed from [Job Name], [Job No. & Job Name], or [Job Name & Job No.].
User Name	Set whether the user name set in the printer driver is displayed. Value: Off, On

Item	Description
Paper Feed Mode	<p>While printing from the computer, select how to feed paper when the paper source and type are specified.</p> <p>Value</p> <p>Auto: Search the paper source that matches the selected paper size and type. Fixed: Print on paper loaded in the specified paper source.</p>
Auto cassette Change	<p>Select the action that takes place when the cassette runs out of paper during printing.</p> <p>Value</p> <p>Off: When paper runs out, printing stops. Printing will resume when you add paper to the paper cassette or select a different paper cassette. On: If there is another cassette with the same size and type of paper, printing will automatically continue.</p>
Gloss Mode	<p>Gloss Mode, when set to [On], increases the effect of glossiness in printing by reducing the printing speed by half.</p> <p>Value: Off, On</p> <p> IMPORTANT: Gloss Mode is not available when Labels and Transparency is selected as the paper type setting. (Refer to <i>Cassette/MP Tray Settings on page 9-7.</i>)</p> <p>Depending on the paper used, printing in gloss mode may cause wrinkle in paper. To reduce wrinkle, try using thicker paper.</p>

System/Network

Configures machine system settings.

Network

Configures network settings.

Host Name

Item	Description
Host Name	Check the host name of the machine.

TCP/IP Settings

Item	Description
TCP/IP	Set up TCP/IP to connect to the Windows network.* Value: Off, On
IPv4 Settings	Set up TCP/IP (IPv4) to connect to the network. The IPv4 setting is available when selecting [On] for [TCP/IP].*
DHCP	Select whether or not to use the DHCP (IPv4) server. Value: Off, On
Auto-IP	Select whether or not to use Auto-IP. Value: Off, On
IP Address	Set the IP addresses. When the DHCP setting is [On], the current IP address is displayed and cannot be changed. When setting an IP address, set the DHCP setting to [Off]. Value: ###.###.###.###
Subnet Mask	Set the IP subnet masks. When the DHCP setting is [On], the current Subnet Mask is displayed and cannot be changed. When setting an Subnet Mask, set the DHCP setting to [Off]. Value: ###.###.###.###
Default Gateway	Set the IP gateway addresses. When the DHCP setting is [On], the current Default Gateway is displayed and cannot be changed. When setting an Default Gateway, set the DHCP setting to [Off]. Value: ###.###.###.###

* After changing the setting, restart the system or turn the machine OFF and then ON.

Item	Description
IPv6 Settings	Set up TCP/IP (IPv6) to connect to the network. The IPv6 setting is available when selecting [On] for [TCP/IP].*
IPv6	Sets whether to use IPv6. Value: Off, On
Manual Setting	Manually specify the IP address, prefix length, and gateway address of TCP/IP (IPv6). The Manual Setting is available when selecting [On] for [IPv6]. Value IP Address (Manual): (numbers (128 bit in total) separated by colons) Prefix Length: 0 to 128 Default Gateway: (Enter the gateway address.)  NOTE: [Default Gateway] is displayed when selecting [Off] for [RA (Stateless)].
RA (Stateless)	Select whether or not to use RA (Stateless). The RA (Stateless) setting is available when selecting [On] for [IPv6]. When selecting [On], [IP Address 1 (to 5)] appears under [IP Address (Stateless)/Prefix Length]. Value: Off, On
DHCP	Select whether or not to use the DHCP (IPv6) server. The DHCP (IPv6) setting is available when selecting [On] for [IPv6]. Value: Off, On
Bonjour	Select whether to use Bonjour. Value: Off, On

* After changing the setting, restart the system or turn the machine OFF and then ON.

Item	Description
Protocol Detail	The table below lists the network related function settings. The network related functions are available when [TCP/IP] is [On].
NetBEUI	Selects whether or not to receive documents using NetBEUI.* Value: Off, On
LPD	Select whether or not to receive documents using LPD as the network protocol.* Value: Off, On
SMTP (E-mail TX)	Select whether or not to send e-mail using SMTP. Value: Off, On
POP3 (E-mail RX)	Select whether or not to receive e-mail using POP3. Value: Off, On
FTP Client (Transmission)	Select whether or not to send documents using FTP. When selecting [On], set the FTP Port Number. Use the FTP default port 21. Value: Off, On, Port: 1 - 65535
FTP Server (Reception)	Select whether or not to receive documents using FTP.* Value: Off, On
SMB Client (Transmission)	Select whether or not to send documents using SMB. When selecting [On], set the SMB default Port Number. Use the SMB default port 139. For Windows Vista, use 445. Value: Off, On, Port: 1 - 65535
LDAP	Select whether or not to use LDAP. Value: Off, On
SNMP	Select whether or not to communicate using SNMP.* Value: Off, On
SNMPv3	Select whether or not to communicate using SNMPv3.* Value: Off, On
HTTP	Select whether or not to communicate using HTTP.* Value: Off, On
HTTPS	Select whether or not to communicate using HTTPS. SSL must be set to [On] in <i>SSL on page 9-22</i> .* Value: Off, On
IPP	Select whether or not to communicate using IPP. When selecting [On], set the IPP default Port Number. Use the IPP default port 631.* Value: Off, On, Port: 1 - 32767
IPP over SSL	Select whether or not to use IPP over SSL. When selecting [On], set the IPP over SSL default Port Number. Use the IPP over SSL default port 443. SSL must be set to [On] in <i>SSL on page 9-22</i> .* Value: Off, On, Port:1 - 32767
RAW Port	Select whether or not to communicate using Raw Port.* Value: Off, On
ThinPrint	Select whether or not to use ThinPrint. When selecting [On], set the default ThinPrint Port Number. Use the ThinPrint default port 4000.* Value: Off, On, Port: 1 - 32767  NOTE: This function is displayed only when the optional ThinPrint Option is activated.
ThinPrintOverSSL	Select whether or not to use ThinPrintOverSSL. SSL must be set to [On] in <i>SSL on page 9-22</i> . Value: Off, On  NOTE: When selecting [On], the certificates must be installed. For details, refer to the <i>Command Center RX User Guide</i> .

* After changing the setting, restart the system or turn the machine OFF and then ON.

WSD Scan

Item	Description
WSD Scan	Select whether or not to use WSD Scan.* Value: Off, On

* After changing the setting, restart the system or turn the machine OFF and then ON.

WSD Print

Item	Description
WSD Print	Select whether or not to use WSD Print.* Value: Off, On

* After changing the setting, restart the system or turn the machine OFF and then ON.

Enhanced WSD

Item	Description
Enhanced WSD	Select whether to use Enhanced WSD.* Selecting [Off] will disable the functionality of WIA and TWAIN drivers. If you want to disable KYOCERA Net Viewer functionality, Enhanced WSD, Enhanced WSD (SSL), SNMP and SNMPv3 (refer to <i>Protocol Detail on page 9-21</i>) must be set to [Off]. Value: Off, On

* After changing the setting, restart the system or turn the machine OFF and then ON.

Enhanced WSD (SSL)

Item	Description
Enhanced WSD (SSL)	Select whether to use Enhanced WSD (SSL).* Value: Off, On

* After changing the setting, restart the system or turn the machine OFF and then ON.



IPSec

Item	Description
IPSec	Make this setting when you use IPSec.* Value: Off, On

* After changing the setting, restart the system or turn the machine OFF and then ON.

Secure Protocol

Item	Description
SSL	Select whether or not to use SSL.* Value: Off, On
IPP Security	Select the IPP security level.* Value: IPP/IPP over SSL, IPPoverSSL only
HTTP Security	Select the HTTP security level.* Value: HTTP/HTTPS, HTTPS Only

Item	Description
LDAP Security (Ext. Address Book)	Select the communication protocol according to the type of security employed by the LDAP server.
LDAP Security (User Property)	<p>Value</p> <p>Off: Do not use security employed by the LDAP server.</p> <p>SSL/TLS: Encryption is applied to any data communication. To enable LDAP security, the LDAP port may have to be changed according to the server settings. Typically, 636** for SSL/TLS is well-known LDAP port.</p> <p>STARTTLS: Encryption is applied to any data communication. Typically, 389** for STARTTLS is well-known LDAP port.</p> <p> NOTE: LDAP must be set to [On] in <i>Protocol Detail on page 9-21</i>.</p>
SMTP Security	<p>Select the communication protocol according to the type of security employed by the SMTP server.</p> <p>Value</p> <p>Off: Do not use security employed by the SMTP server.</p> <p>SSL/TLS: Encryption is applied to any data communication. To enable SMTP security, the SMTP port may have to be changed according to the server settings. Typically, 465** for SSL/TLS is well-known SMTP port.</p> <p>STARTTLS: Encryption is applied to any data communication. Typically, 25** or 587** for STARTTLS is well-known SMTP port.</p> <p> NOTE: SMTP must be set to [On] in <i>Protocol Detail on page 9-21</i>.</p>
POP3 Security (User 1)	Select the communication protocol according to the type of security employed by the POP3 server.
POP3 Security (User 2)	Value
POP3 Security (User 3)	<p>Off: Do not use security employed by the POP3 server.</p> <p>SSL/TLS: Encryption is applied to any data communication. To enable POP3 security, the POP3 port may have to be changed according to the server settings. Typically, 995** for SSL/TLS is well-known POP3 port.</p> <p>STARTTLS: Encryption is applied to any data communication. Typically, 110** for STARTTLS is well-known POP3 port.</p> <p> NOTE: POP3 must be set to [On] in <i>Protocol Detail on page 9-21</i>.</p>

* After changing the setting, restart the system or turn the machine OFF and then ON.

** You can change the port number using Command Center RX.

LAN Interface

Item	Description
LAN Interface	<p>Specify the settings for the LAN interface to be used.*</p> <p>Value: Auto, 10Base-Half, 10Base-Full, 100Base-Half, 100Base-Full, 1000BASE-T</p>

* After changing the setting, restart the system or turn the machine OFF and then ON.

Restart Network

Item	Description
Restart Network	Restarts the network.



Optional Network



NOTE

This function is displayed when the optional Network Interface Kit is installed.



Wireless Network

Item	Description
Connection Status	When the optional Wireless Interface Kit is installed, you can check the wireless LAN status.
Quick Setup Wizard	If the machine will connect to an access point that supports the automatic wireless network setup, connection settings can be configured by Quick Setup.
Available Network	Displays access points to which the machine can connect.
Push Button Method	If the access point supports the push button method, wireless settings can be configured using the push button. This setting executes push button, and the connection is started by pressing the push button on the access point.
PIN Code Method(Device)	Starts connection using the machine's PIN code. Enter the PIN code into the access point. The PIN code of the machine is automatically generated.
PIN Code Method(Terminal)	Starts connection using the PIN code of the access point. Enter the PIN code of the access point.
Custom Setup	The detailed settings for wireless LAN can be changed.
Network Name(SSID)	Set the SSID (Service Set Identifier) of the wireless LAN to which the machine connects.  NOTE: Up to 32 characters can be entered.
Connection Mode	Set the connection mode. Value: Ad Hoc, Infrastructure  NOTE: Ad Hoc: Directly communicates with the device without going through an access point. This method cannot be used to connect to two or more devices. Infrastructure: Performs communication through an access point.
Channel	Set channel. Use [-] / [+] or the numeric keys to enter a number. Value: 1 to 11
Network Authentication	Select network authentication type. To select other options, open the device home page from a computer. Value: Open, Shared, WPA-PSK ^{*1} , WPA2-PSK ^{*1}
Encryption	Select encryption method and enter the Preshared key. The setting values vary depending on the Network Authentication setting. When Network Authentication is set to [Open] or [Shared] Value: Disable, WEP When Network Authentication is set to [WPA-PSK] or [WPA2-PSK] Value: TKIP ^{*2} , AES, Auto ^{*2} , Preshared Key  NOTE: If [WEP] is selected, enter the WEP key. Up to 26 characters can be entered. If [Preshared Key] is selected, enter the Preshared key. Enter the value in 8 to 64 characters.

*1 Not displayed if you selected [Ad Hoc] for "Connection Mode".

*2 Not displayed if you selected [WPA2-PSK] for "Network Authentication".

Basic

Item	Description
Host Name	Check the host name of the machine standard NIC. Host name can be changed from Command Center RX.  Refer to <i>Changing Device Information</i> on page 2-33
TCP/IP Setting	For details on setting value, refer to <i>TCP/IP Settings</i> on page 9-19.
LAN Interface	Select the LAN Interface type.* Value: Auto, 10Base-Half, 10Base-Full, 100Base-Half, 100Base-Full, 1000BASE-T  NOTE: This function is displayed when the optional Network Interface Kit is installed.
MAC Address Filter	Select whether to use MAC Address Filter. See the Operation Guide for the optional network interface card for details. Value: Off, On
Restart Network	Restarts the network card of the device.

* The setting will be changed after restarting the device or network.

Network Interface (Send)**NOTE**

This function is displayed when the optional Network Interface Kit is installed.

Item	Description
Network Interface (Send)	Specify the network interface card to be used for send function and connecting to external address book. Value: Standard, Optional NIC

Interface Block Setting

This allows you to protect this machine by blocking the interface with external devices such as USB hosts or optional interfaces.

Item	Description
USB Host	This locks and protects the USB memory slot. Value: Unblock, Block
USB Device	This locks and protects the USB interface connector. Value: Unblock, Block
USB Storage	This locks and protects the USB memory slot. Value: Unblock, Block  NOTE: This function is available when USB Host is set to [Unblock].
Optional Interface 1*	This locks and protects the optional interface slots.
Optional Interface 2*	Optional Interface 1: FAX Optional Interface 2: Network Value: Unblock, Block
Optional Interface**	This locks and protects the optional interface slot. Value: Unblock, Block

* Only on products with the fax function installed.

** Only on products without the fax function.

RAM Disk Setting

Item	Description
RAM Disk Setting	A RAM disk can be created and its size can be set. Creating a RAM disk makes it possible to print from a Job Box.* Value RAM Disk Setting: Off, On RAM Disk Size: Setting range varies with Optional Memory settings.

* After changing the setting, restart the system or turn the machine OFF and then ON.





Optional Memory

Item	Description
Optional Memory	When optional memory is installed, select the memory allocation scheme based on the application in which you are using the equipment.* Value: Printer Priority, Normal, Copy Priority

* After changing the setting, restart the system or turn the machine OFF and then ON.

Date/Timer/Energy Saver

Configures settings related to the date and time.

Item	Description
Date/Time	Set the date and time for the location where you use the machine. If you perform Send as E-mail, the date and time set here will be displayed on the header. Value: Year (2000 to 2037), Month (1 to 12), Day (1 to 31), Hour (00 to 23), Minute (00 to 59), Second (00 to 59)
Date Format	Select the display format of year, month, and date. The year is displayed in Western notation. Value: Month/Day/Year, Day/Month/Year, Year/Month/Day
Time Zone	Set the time difference from GMT. Choose the nearest listed location from the list.
Auto Panel Reset	If no jobs are run for a certain period of time, automatically reset settings and return to the default setting. Select to use Auto Panel Reset or not. Value: Off, On  NOTE: The time allowed to elapse before the panel is reset is set with the <i>Panel Reset Timer</i> .
Panel Reset Timer	If you select [On] for Auto Panel Reset, set the amount of time to wait before Auto Panel Reset. Value: 5 to 495 seconds (every five seconds)  NOTE: If you select [Off] for [Auto Panel Reset], the time display does not appear.
Low Power Timer	Set amount of time before entering the Low Power mode. Value For Europe: 1 to 60 minutes (1minute increments) Except for Europe: 1 to 240 minutes (1minute increments)  NOTE: Refer to <i>Low Power Mode on page 2-27</i> .
Sleep Rules (models for Europe)	Select whether to use the Sleep mode for the following functions individually: <ul style="list-style-type: none"> • Network • Card Reader*1 • FAX*2 • Application Value: Off, On
Sleep Level (models except for Europe)	Select the sleep level. Set the Energy Saver mode to reduce power consumption even more than normal Sleep mode. Value: Quick Recovery, Energy Saver  NOTE: This function will not be displayed when the optional Network Interface Kit is installed.
Energy Saver	Select whether to use the Energy Saver mode for the following functions individually: <ul style="list-style-type: none"> • Network • Card Reader*1 • FAX*2 • Application Value: Off, On
Sleep Timer	Set amount of time before entering Sleep. Value: 1 to 240 minutes (1 minute increments)
Auto Error Clear	If an error occurs during processing, processing stops to wait for the next step to be taken by the user. In the Auto Error Clear mode, automatically clear the error after a set amount of time elapses. For details, refer to <i>Responding to Error Messages on page 10-13</i> . Value: Off, On

Item	Description
Error Clear Timer	If you select [On] for Auto Error Clear, set the amount of time to wait before automatically clearing errors. Value: 5 to 495 seconds (every five seconds)  NOTE: If you select [Off] for [Auto Error Clear], the time display does not appear.
Unusable Time*2	For details, refer to the <i>FAX Operation Guide</i> .



*1 This is displayed when the optional Card Authentication Kit is installed.

*2 Only on products with the fax function installed.

Adjustment/Maintenance

Adjust printing quality and conduct machine maintenance.

Item	Description
Density Adjustment	Adjust density.
Copy	Adjust copy density. Adjustment can be made in 7 levels. Value: -3 (Lighter), -2, -1, 0 (Normal), +1, +2, +3 (Darker)
Send/Box	Adjust scan density when sending or storing the data in Document Box. Adjustment can be made in 7 levels. Value: -3 (Lighter), -2, -1, 0 (Normal), +1, +2, +3 (Darker)
Background Density Adj.	Darkens or lightens overall background density adjustment.
Copy (Auto)	Darkens or lightens overall background density adjustment during copying. Adjustment can be made in 7 levels. Value: -3 (Lighter), -2, -1, 0 (Normal), +1, +2, +3 (Darker)
Send/Box (Auto)	Darkens or lightens overall background density when sending images or storing them in the Document Box. Adjustment can be made in 7 levels. Value: -3 (Lighter), -2, -1, 0 (Normal), +1, +2, +3 (Darker)
Auto Color Correction	This setting allows you to adjust the detection level used by the machine to determine whether the original is color or black and white during Auto Color Mode. Setting a lower value will result in more originals being identified as color, while a larger value will tend to increase the number of originals being identified as black and white. Value: 1 (Color), 2, 3, 4, 5 (B & W)
Correcting Black Line	Correct fine lines (streaks caused by contamination), which may appear on the image, when the document processor is used. Value Off: No correction performed. On (Low): Correction performed. The reproduction of fine lines on the original may become lighter than when using [Off]. On (High): Select this item if a streak remains after using [On (Low)]. The reproduction of fine lines on the original may become lighter than when using On (Low).
Display Brightness	Set the brightness of the touch panel. Value: 1 (Darker), 2, 3, 4 (Lighter)
Color Registration	When first installing the machine or moving it to a new location, color drift during printing may occur. Use this function to correct the color position of each of cyan, magenta and yellow to resolve color drift. For more information, refer to the <i>Color Registration Procedure</i> below.

Item		Description
Drum Refresh		Remove image blur and white dots from the printout. Takes about 120 seconds. Press [Start] to perform Drum Refresh.  NOTE: Drum Refresh cannot be performed while printing. Execute Drum Refresh after the printing is done.
Calibration		Adjust color drift or hue of printed image in the most appropriate color. Press [Start] to perform Calibration. Press [OK] after Calibration is complete.  NOTE: Perform Color Registration when the color drift is not adjusted even after performing Calibration.
Laser Scanner Cleaning		Remove white and color streaks from the image. Press [Start] to perform Laser Scanner Cleaning.
Service	Altitude Adjustment	This sets the altitude adjustment mode. If you are using the machine at an altitude of 1500 m or higher and print quality has deteriorated, the Altitude Adjustment mode setting can be used to restore print quality. Value: Normal, High 1, High 2
	MC	This sets the output of the main charger. When print quality has deteriorated, the output of the main charger can be changed to restore print quality. Value: 1 - 5  NOTE: This menu only appears when [Altitude Adjustment] is set to [Normal].
	Memory Diagnostics	Perform this function to check the machine memory.

Color Registration Procedure

Normal registration and detailed settings are available for Color Registration. Color drift can be largely corrected through normal registration. However, if it is not resolved or to perform more detailed settings, use the detailed settings.



NOTE

To perform color registration, verify that either Letter or A4 paper is loaded into a cassette.



IMPORTANT

Before performing color registration, be sure to perform Calibration (see page 9-29). If color drift remains, perform color registration. By performing color registration without performing Calibration, the color drift will be resolved once, however, it may cause the serious color drift later.

Normal Registration

1 Display the screen.

◆ System Menu / Counter

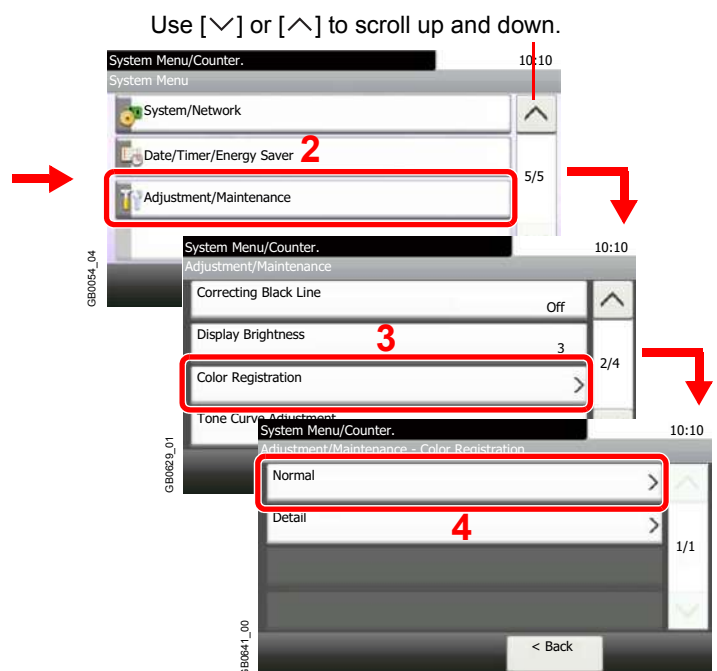
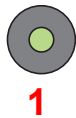

2 Print the chart.

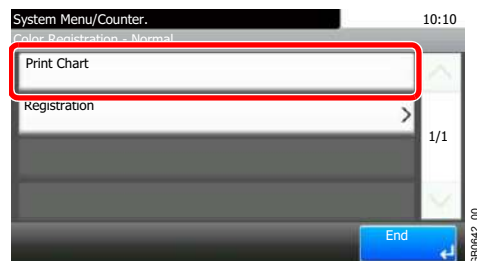

A chart is printed. On the chart, for each of M (magenta), C (cyan) and Y (yellow), 3 chart types are printed on one sheet: H-L (left), V (vertical), H-R (right).

Chart Example

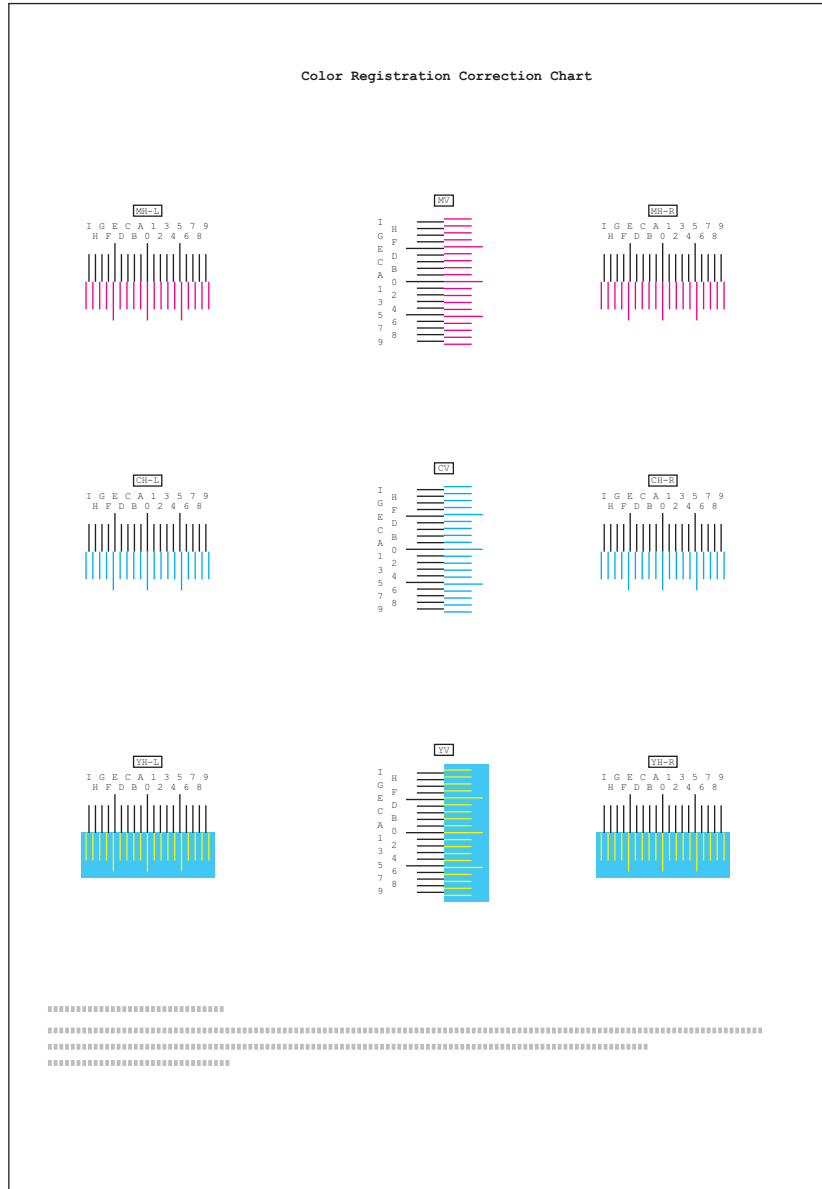

3 Enter the appropriate value.

- 1 Find the location on each chart where 2 lines most closely match. If this is the 0 position, registration for that color is not required. For the illustration, B is the appropriate value.

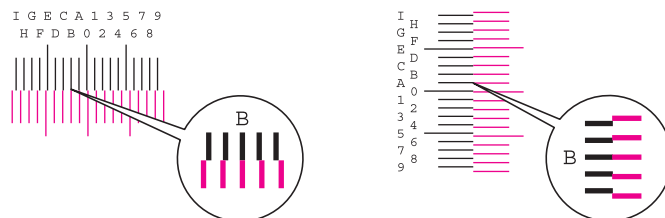

2

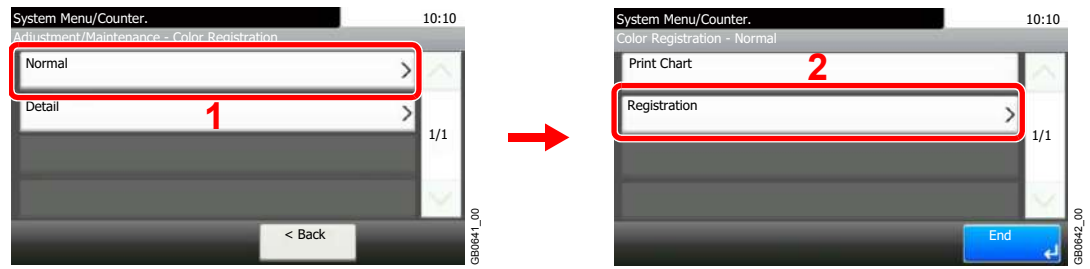

3 Select the chart to be corrected.

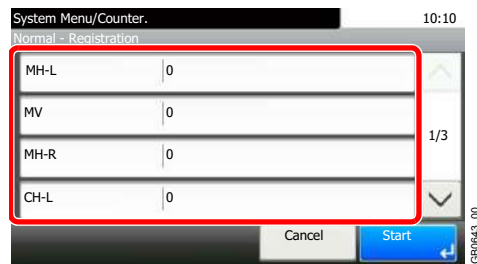

4 Press [+] or [-] to enter the values read from the chart.

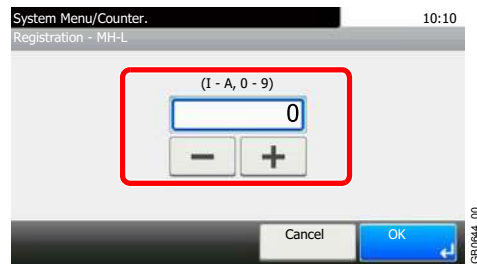

Press [+] to increase the value from 0 to 9. To decrease, press [-].

By pressing [-], the value changes from 0 to alphabetic letters, going from A to I. To move in the reverse direction, press [+].

You cannot use the numeric keys to enter these values.

5 Repeat steps 3 and 4 to enter the registration values for each chart.

6 Press [Start] after all values have been entered. Color registration begins.

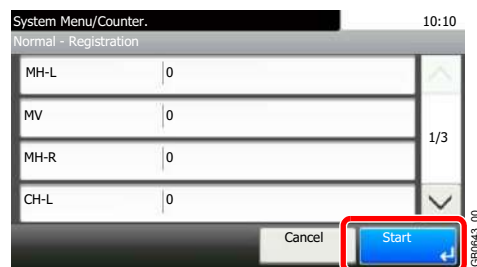

7 Press [OK] after color registration is complete.

Detailed Settings

1 Display the screen.

◆ System Menu / Counter

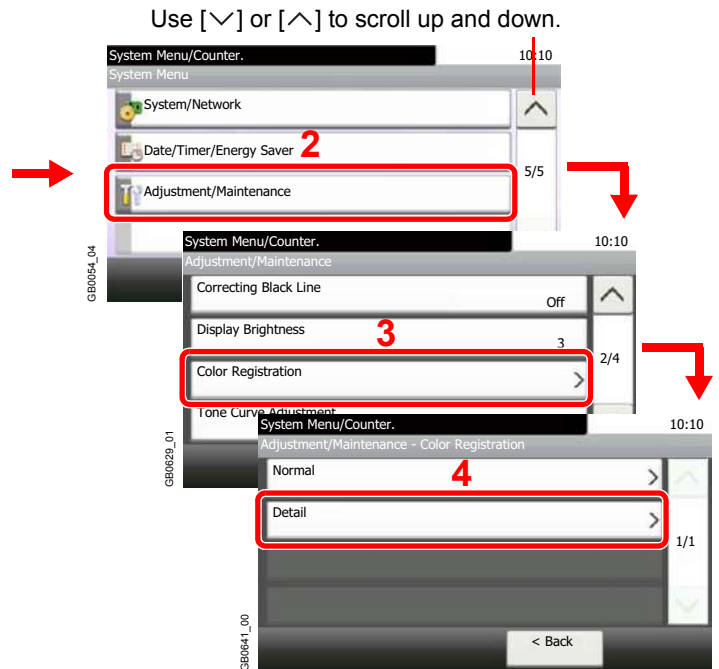

2 Print the chart.

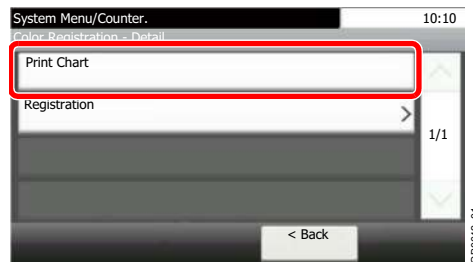

A chart is printed. On the chart, for each of M (magenta), C (cyan) and Y (yellow), charts for H-1 to 9 and V-1 to 5 are printed.

Chart Example

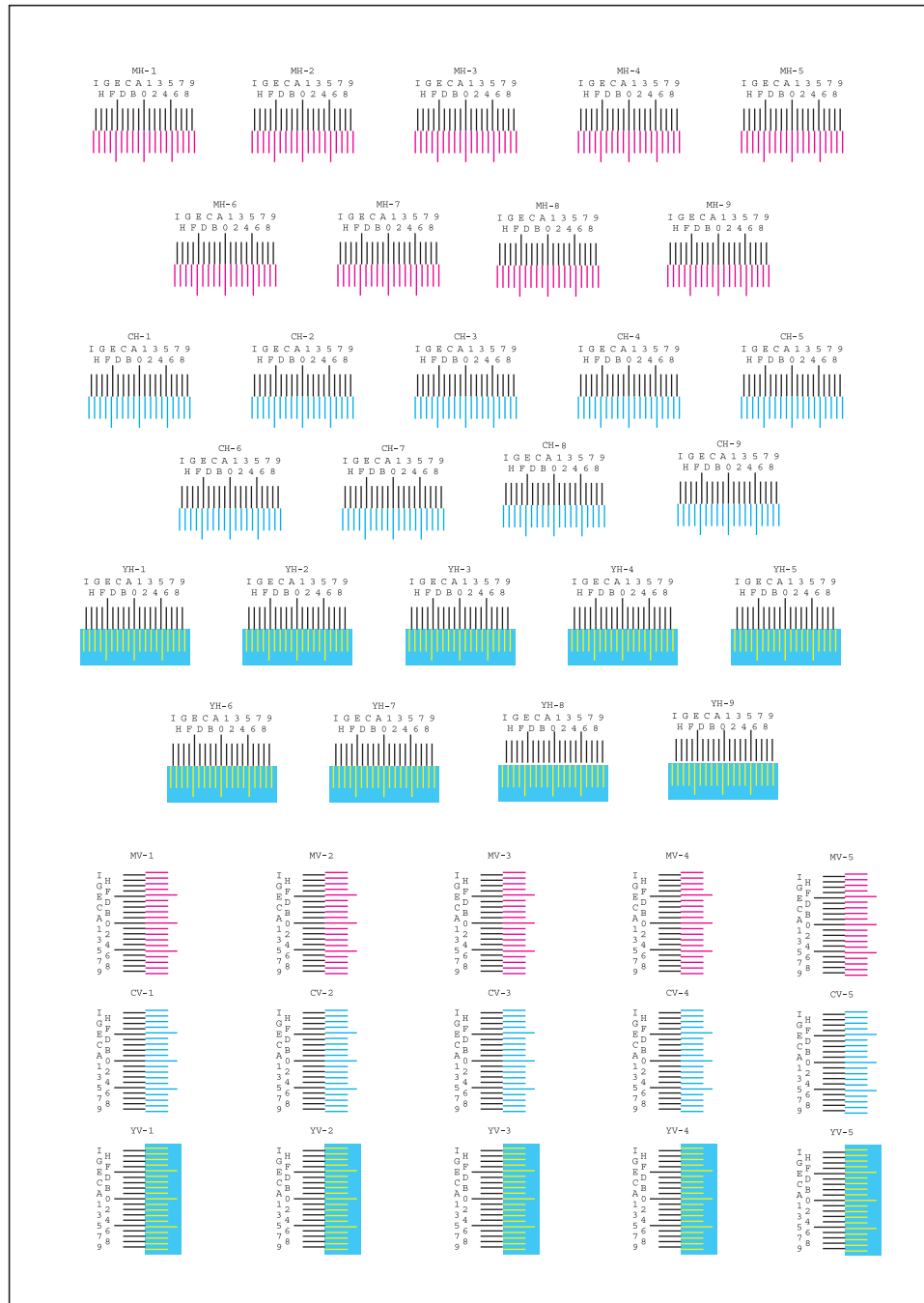

3 Enter the appropriate value.

- 1 Find the location on each chart where 2 lines most closely match. If this is the 0 position, registration for that color is not required. For the illustration, B is the appropriate value.

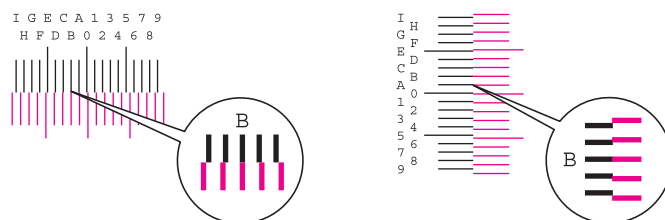

From charts H-1 to H-9, read only the values from H-1 to H-5.

From charts V-1 to V-5, read only the values from V-3 (center).

2

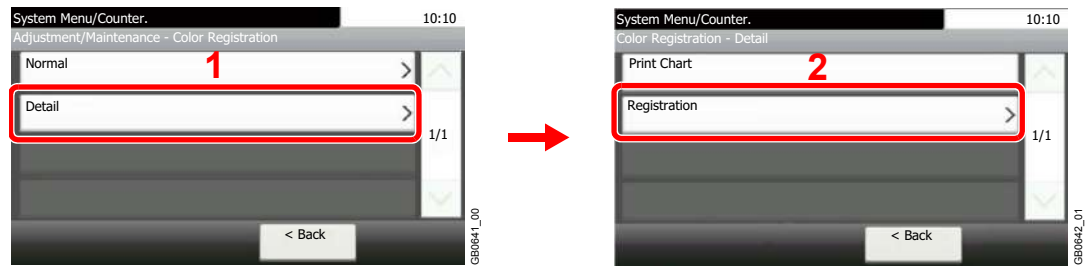

3 Select the chart to be corrected.

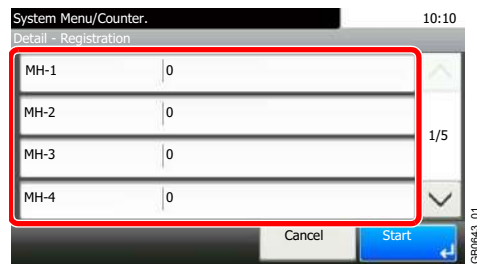

4 Press [+] or [-] to enter the values read from the chart.

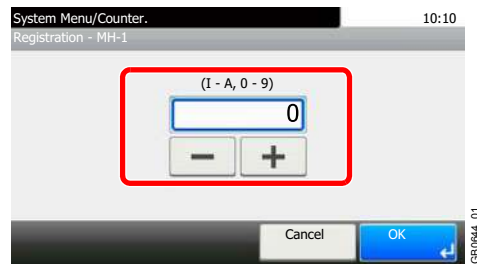

Press [+] to increase the value from 0 to 9. To decrease, press [-].

By pressing [-], the value changes from 0 to alphabetic letters, going from A to I. To move in the reverse direction, press [+].

You cannot use the numeric keys to enter these values.

5 Repeat steps 3 and 4 to enter the registration values for each chart.

6 Press [Start] after all values have been entered. Color registration begins.

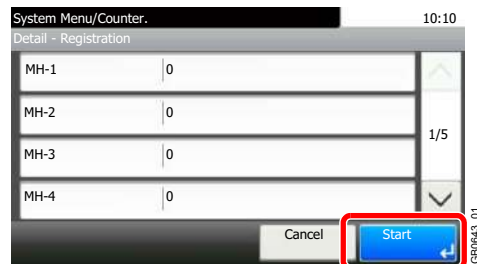

7 Press [OK] after color registration is complete.

User Login Administration

User login administration specifies how the user access is administered on this machine. Enter correct login user name and password for user authentication to login.

Access are in three levels - User, Administrator, and Machine Administrator. The security levels can be modified only by the machine administrator.

First User Login Administration

Follow these steps for the first user login administration. For details about the configuration method, refer to *User Login Settings* on page 9-37.

1 Enable user login administration.

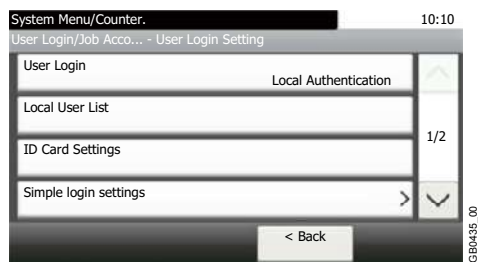

2 Add a user.



3 Log out.

Logout



4 The registered user logs in for operations.



User Login Settings

1 Display the screen.

◆ System Menu / Counter



1

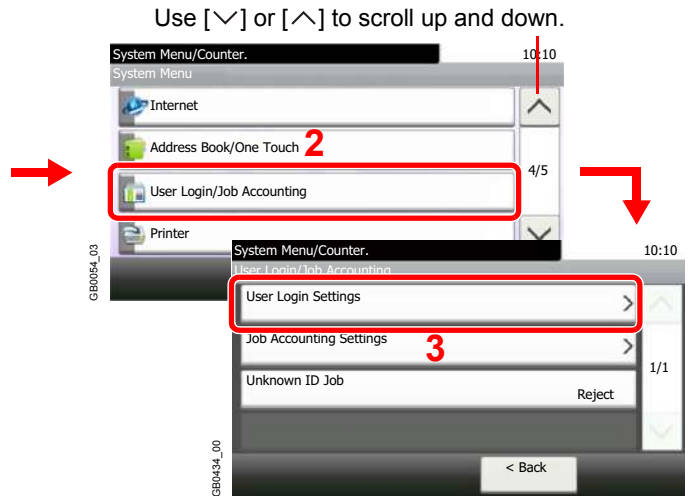

NOTE

You can only change the settings by logging in with administrator privileges. Refer to *Adding a User on page 9-40* for the default login user name and password.

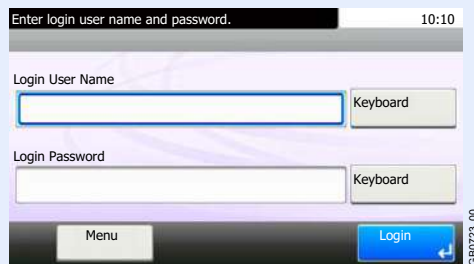

2 Configure the function.



- Enabling/Disabling User Login Administration ▶ page 9-38
- Adding a User ▶ page 9-40
- Local User Authorization ▶ page 9-45
- Editing and Deleting Users ▶ page 9-47
- ID Card Settings ▶ page 9-50
- Simple Login ▶ page 9-51
- Group Authorization ▶ page 9-57
- Obtain Network User Property ▶ page 9-61

Enabling/Disabling User Login Administration

This enables user login administration. Select one of the following authentication methods:

Local Authentication	User authentication based on user properties on the local user list stored in the machine.
Network Authentication	User authentication based on Authentication Server. Use a user property stored in Authentication Server to access the network authentication login page.

1 Display the screen.

1 Referring to *User Login Settings* on page 9-37, display the screen.

2

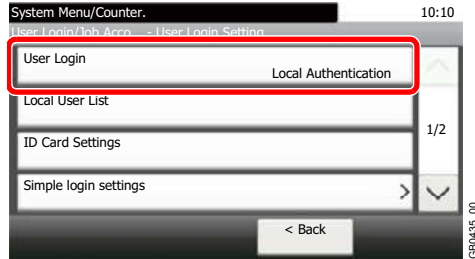

2 Select the authentication method.

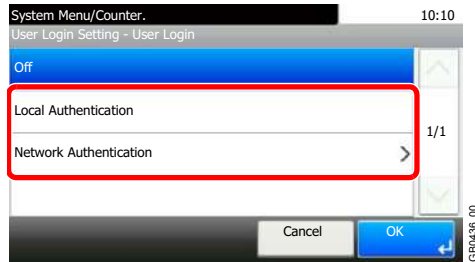

When selecting [Network Authentication]

Select the server type.

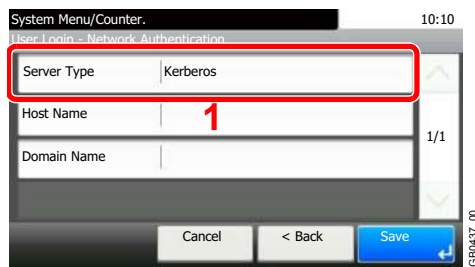

Enter the host name.

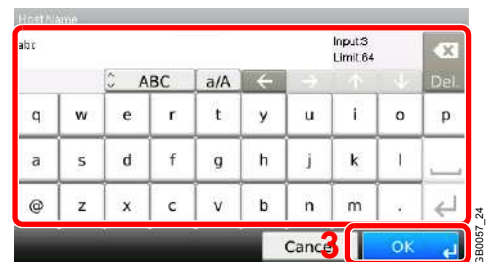
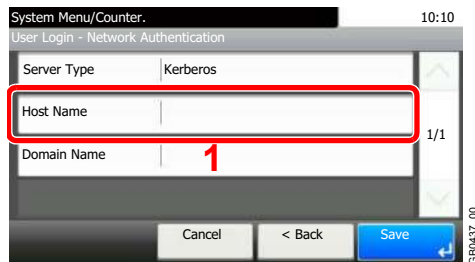

Up to 64 characters can be entered.

 Refer to *Character Entry Method* on page 11-8 for details on entering characters.

Enter a domain name.

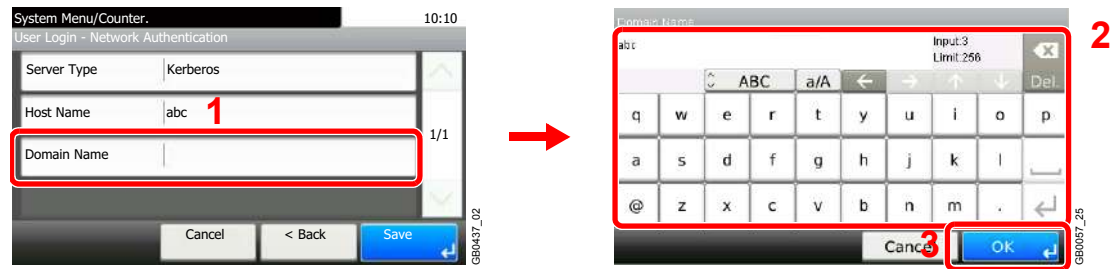

When selecting [NTLM] or [Kerberos] as the server type, enter a domain name of 256 characters or less.

Enter the port number.

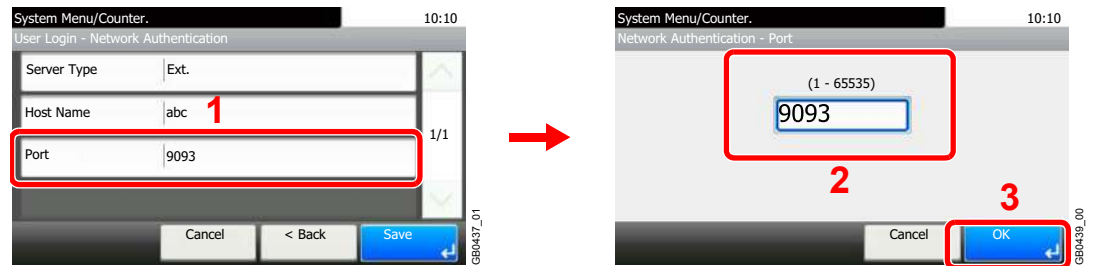

When selecting [Ext.] as the server type, enter the port number.

Press [Save].

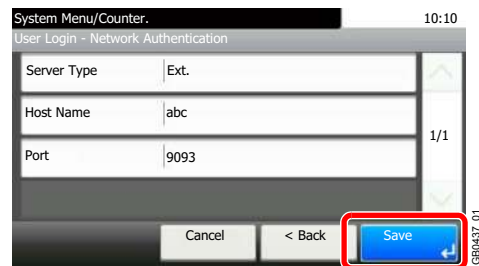

NOTE

If the login user name and password are rejected, check the following settings.



- Network Authentication setting of the machine
- User property of the Authentication Server
- Date and time setting of the machine and the Authentication Server

If you cannot login because of the setting of the machine, login with any administrator registered in the local user list and correct the settings. If the server type is [Kerberos], only domain names entered in uppercase will be recognized.

Adding a User

This adds a new user. You can add up to 100 users (including the default login user name).

The table below explains the user information to be registered.

User Name*	Enter the name displayed on the user list (up to 32 characters).
Login User Name*	Enter the login user name to login (up to 64 characters). The same login user name cannot be registered.
Login Password	Enter the password to login (up to 16 characters).
Account Name	Add an account where the user belongs. The user, who registered his/her account name, can login without entering the account ID. Refer to <i>Job Accounting on page 9-63</i> .
E-mail Address	The user can register his/her E-mail address (up to 128 characters). The registered address will be automatically selected for subsequent operations that need any E-mail function.
Access Level*	Select Administrator or User for user access privileges.
ID Card Info.	Register ID card information. Place the ID card on the ID card reader, and press [Read].  NOTE: This function is displayed when the optional ID Card Authentication Kit is activated.  Refer to <i>Card Authentication Kit on page 11-4</i> .
My Panel	Registers settings for individual users. Settings registered here can be applied simply by logging in.
Local Authorization	Restricts the use of the machine by user. Local user authorization must be enabled to use this function (see page 9-45). The following restriction items are available: Printer: Select whether or not to reject usage of print functions for the printer. Printer (Full Color): Select whether or not to reject usage of full-color print functions for the printer. Copy: Select whether or not to reject usage of copy functions. Copy (Full Color): Select whether or not to reject usage of full-color print functions for copies. Send: Select whether or not to reject usage of send functions other than faxing. FAX Transmission: Select whether or not to reject usage of the FAX transmissions. Storing in Box: Select whether or not to reject usage of storing in the document boxes. Storing in Memory: Select whether or not to reject usage of storing in the removable memory.

* Mandatory at user registration.



NOTE

By default, one of each default user with machine administrator rights and administrator privileges is already stored. Each user's properties are:

Item	Machine Administrator	Administrator
User Name	DeviceAdmin	Admin
Login User Name	2600	Admin
Login Password	2600	Admin
Access Level	Machine Administrator	Administrator

It is recommended to periodically change the user name, login user name and login password regularly for your security.

1 Display the screen.

1 Referring to *User Login Settings* on page 9-37, display the screen.

2

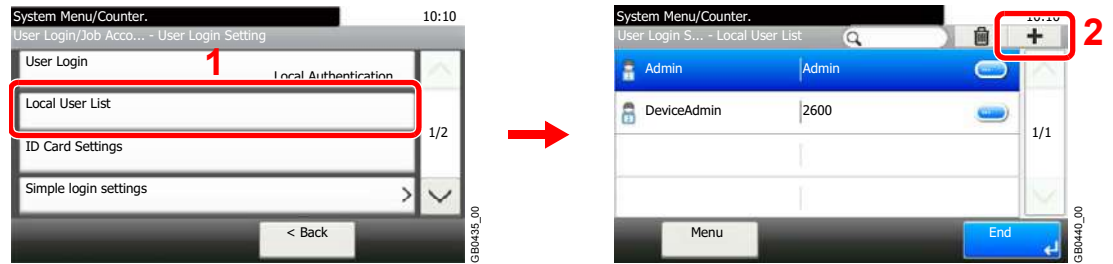

2 Enter the user information.

[User Name]

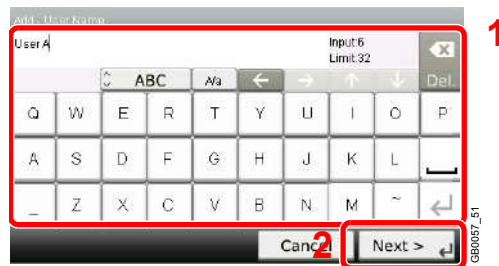

[Login User Name]



[Access Level]

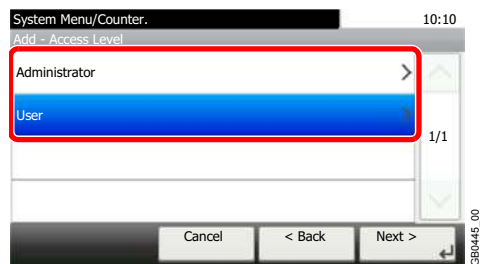

Select the user access privilege.

3 Check the settings.

Check the settings and change or add information as needed.

[User Name]

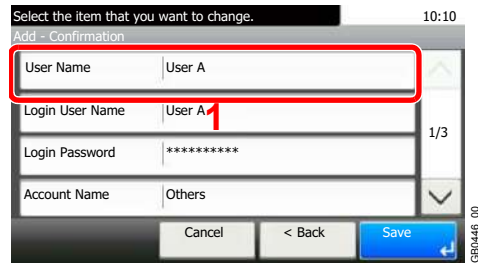

[Login User Name]

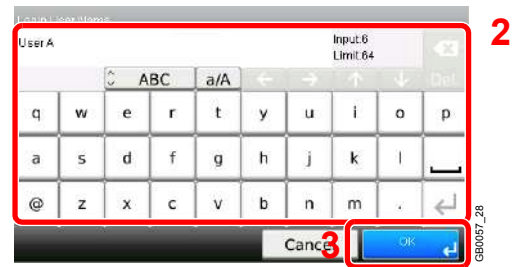
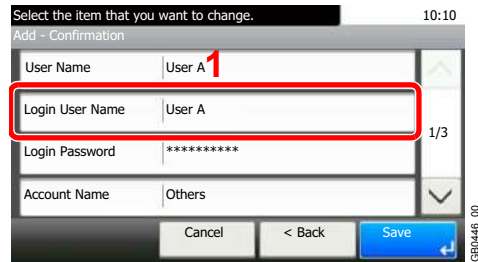

[Login Password]

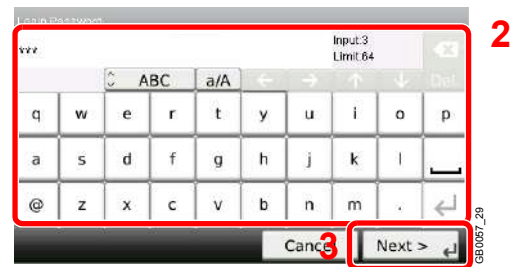
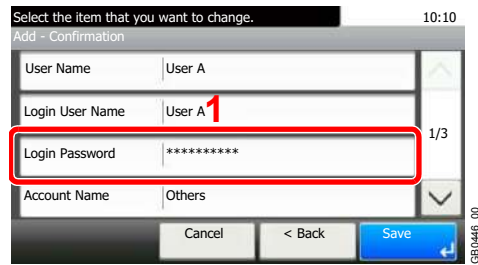

Enter the same login password twice for confirmation purposes.

[Accounting Name]

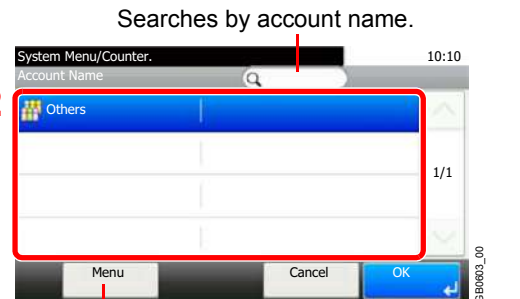
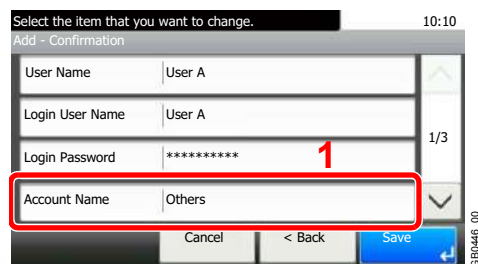

Allows you to search for an account name and sorts results.

[E-mail Address]

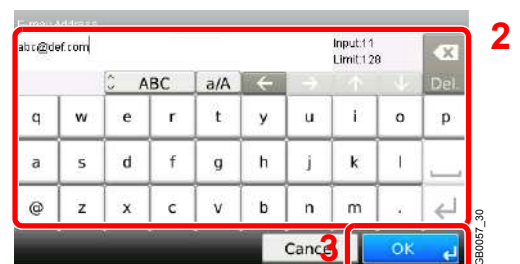
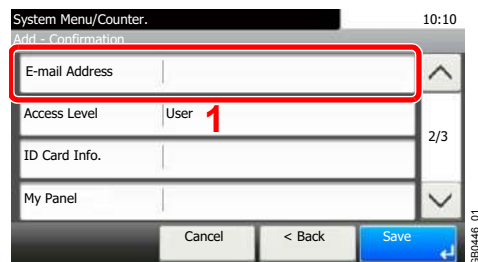

[Access Level]

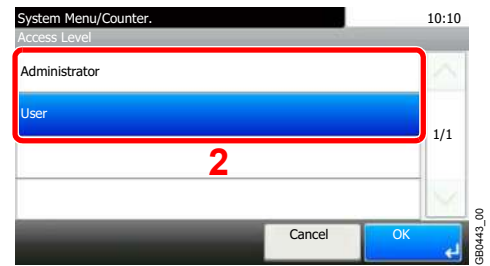
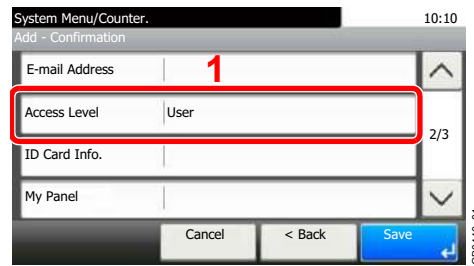

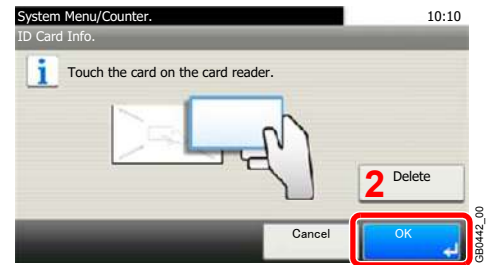
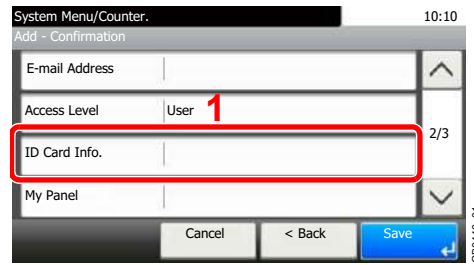

Select the user access privilege.

[ID Card Info.]





Register ID card information. Touch the card on the card reader.

 **NOTE:** This function is displayed when the optional ID Card Authentication Kit is activated.

 Refer to *Card Authentication Kit* on page 11-4.

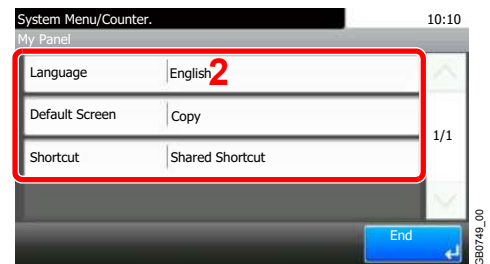
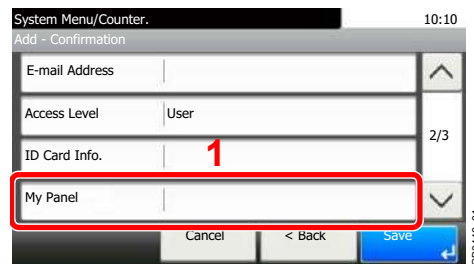
[My Panel]



 For details on My Panel, refer to *My Panel* on page 9-46.

[Local Authorization]

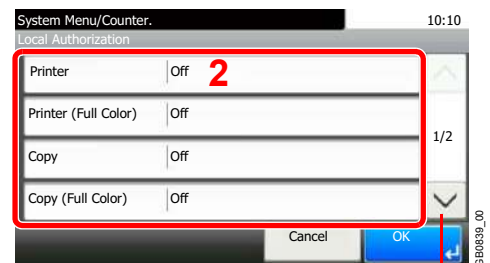
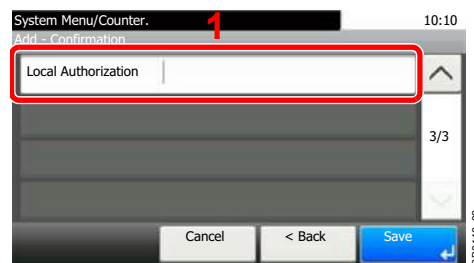

Use [∨] or [∧] to scroll up and down.

Change the limitations as needed.

4 Register the user.

Select the item that you want to change. 10:10

Add - Confirmation

User Name	User A	↑
Login User Name	User A	1/3
Login Password	*****	
Account Name	Others	↓

Cancel < Back Save

981446_00

A screenshot of a mobile application interface for user registration. The screen displays a form titled "Add - Confirmation" with four input fields: "User Name" (User A), "Login User Name" (User A), "Login Password" (masked with asterisks), and "Account Name" (Others). At the bottom, there are three buttons: "Cancel", "< Back", and "Save". The "Save" button is highlighted with a red rectangular box. The top of the screen shows a status bar with the time "10:10" and a header "Select the item that you want to change." A small identifier "981446_00" is visible on the right side of the screen.

Local User Authorization

Enables local user authorization. Job use can be prohibited for specific users. Set when adding a user (see page 9-40) or editing and deleting users (see page 9-47).

1 Display the screen.

1 Referring to *User Login Settings* on page 9-37, display the screen.

2

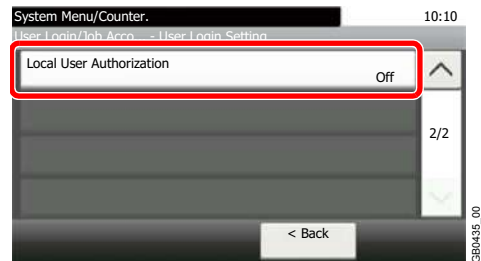

2 Select [On].

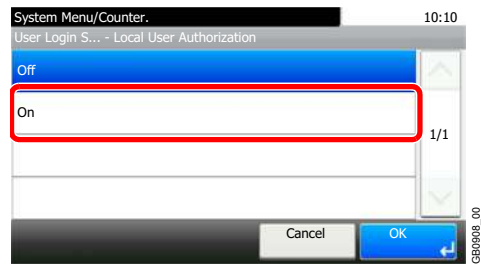

My Panel

Registers settings for individual users. Settings registered here can be applied simply by logging in. Set when *Adding a User* (see page 9-40) or *Editing and Deleting Users* (see page 9-47).

Environments in which shortcut can be configured

Language	Select the language displayed on the touch panel.
Default Screen	Set the screen appearing right after the user logs in (default screen).
Shortcut	Select either [Shared Shortcut] or [Private Shortcut].

[Language]

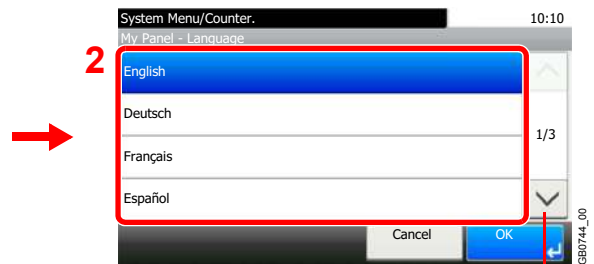
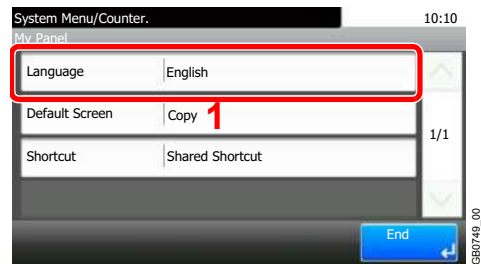

Use [∨] or [∧] to scroll up and down.

[Default Screen]

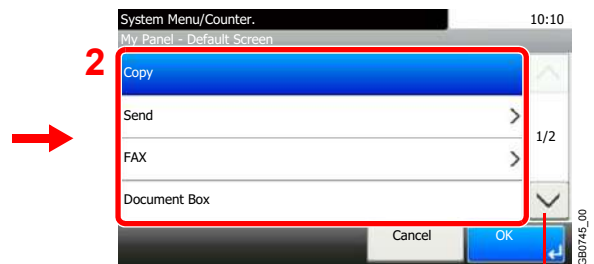
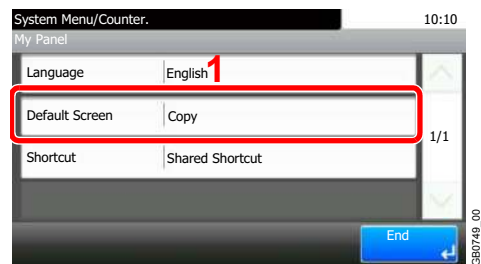

Use [∨] or [∧] to scroll up and down.

When [Send] or [FAX] has been selected, sets which screen to use as the default screen.

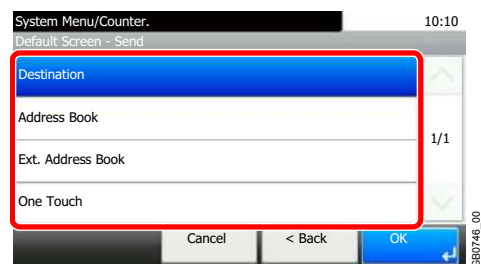

[Shortcut]

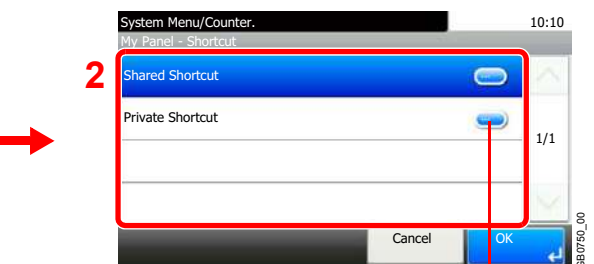
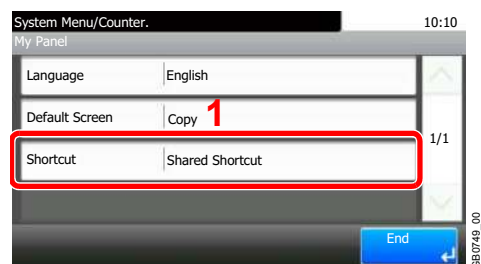

Displays details for individual shortcuts.

Editing and Deleting Users

User properties can be changed and users can be deleted.

NOTE

To change the user information of the machine administrator, you must log in with machine administrator authority. You can only view user information if you log in as a regular user.

1 Display the screen.

1 Referring to *User Login Settings on page 9-37*, display the screen.

2

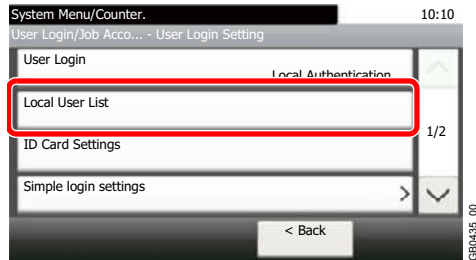

2 Edit or delete a user.

To edit a user

1 Press [...] for the user whose settings you wish to edit.

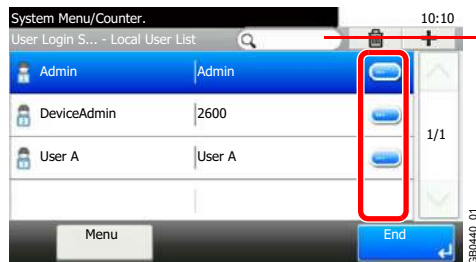

Searches by user name.

2 Edit the user.

For more information about individual settings, refer to *Adding a User on page 9-40*.

[User Name]

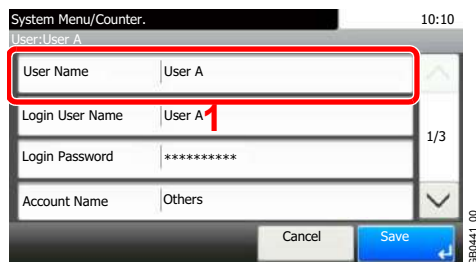

[Login User Name]

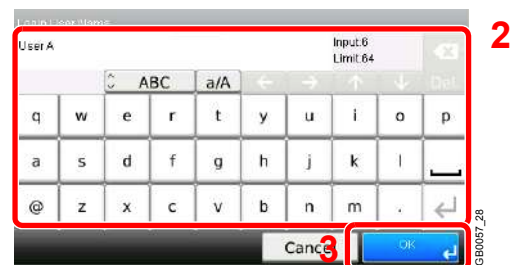
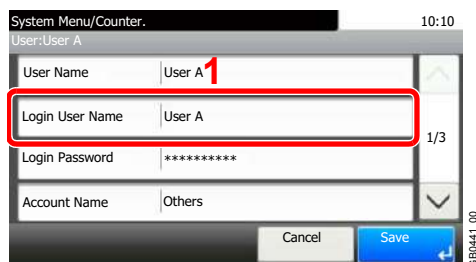

[Login Password]

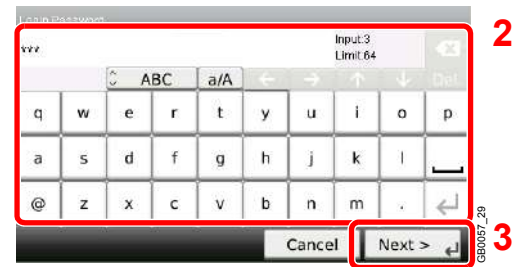
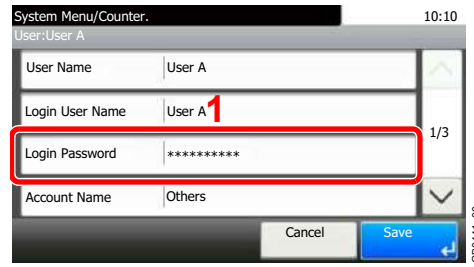

Enter the same login password twice for confirmation purposes.

[Account Name]

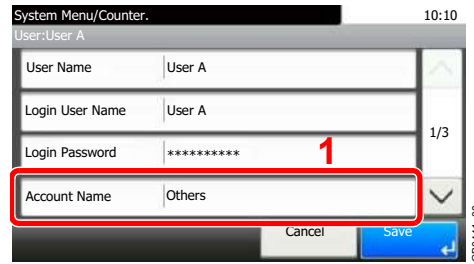

Searches by account name.

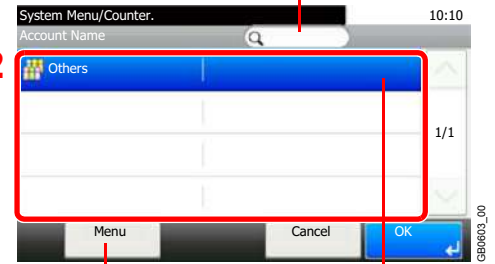

Allows you to search for an account name and sorts results.
Displays details for individual account names.

[E-mail Address]

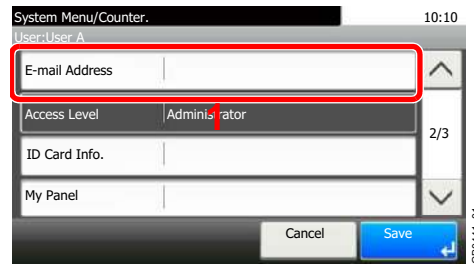

[ID Card Info.]

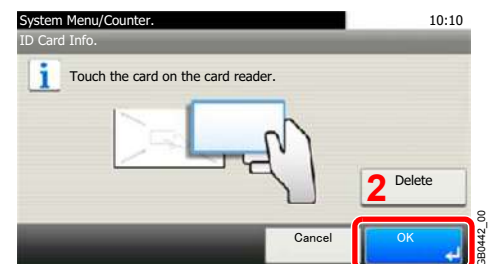
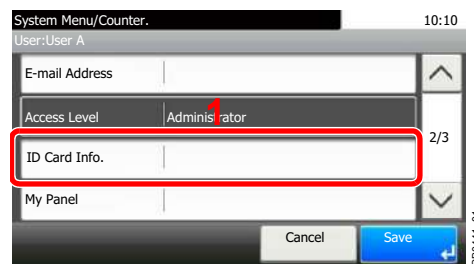

Register ID card information. Touch the card on the card reader.

 **NOTE:** This function is displayed when the optional ID Card Authentication Kit is activated.

 Refer to *Card Authentication Kit* on page 11-4.

[My Panel]

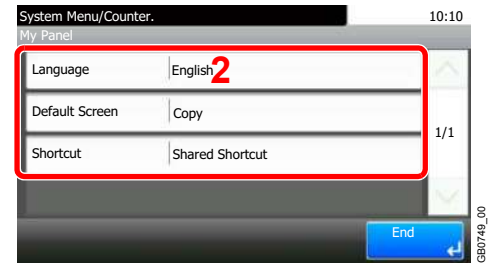
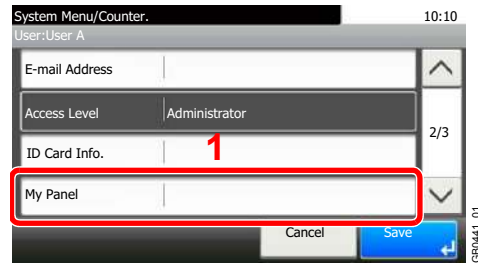

For details on My Panel, refer to *My Panel* on page 9-46.

[Local Authorization]

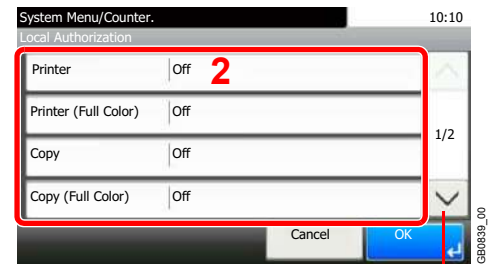
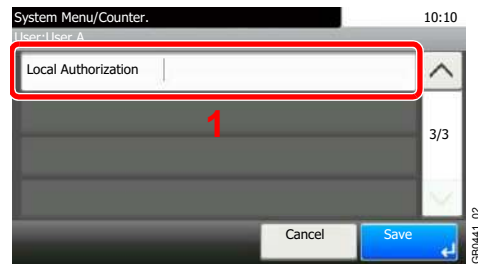

Use [∨] or [∧] to scroll up and down.

[Local Authorization] is displayed when selecting [On] for [Local User Authorization].

Refer to *Local User Authorization* on page 9-45.

3 Register the user.

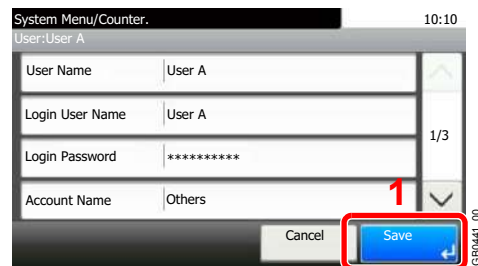

To delete

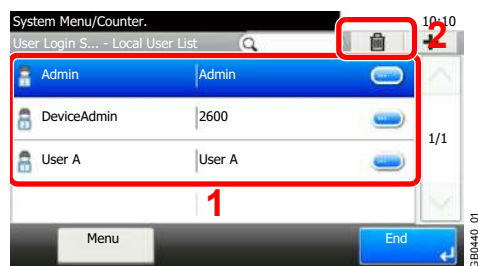

Select the user you wish to delete and press [(Delete)] (the trash can icon).



NOTE

Also, you can delete the user by selecting the user, press [Menu] and then [Delete].

ID Card Settings

If ID card authentication is enabled, select the authentication type.

 **NOTE**

This functions appears when the Card Authentication kit is activated.

 Refer to *Local User Authorization* on page 9-45.

This function does not appear when the user logs in as a network authentication user.

The following settings can be selected.

Keyboard Login	When ID card authentication is enabled, select whether or not login by keyboard is allowed.
Password Login	Select whether or not to require password entry after authenticating by ID card.

1 Display the screen.

1 Referring to *User Login Settings* on page 9-37, display the screen.

2

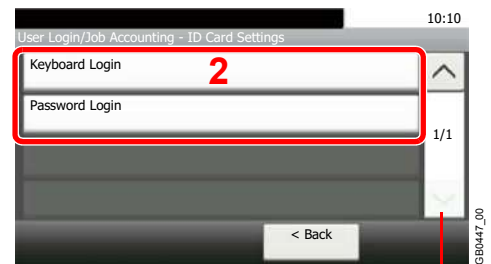
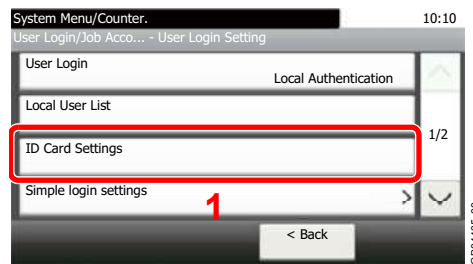

Use [∨] or [∧] to scroll up and down.

2 Configure the settings.

[Keyboard Login]

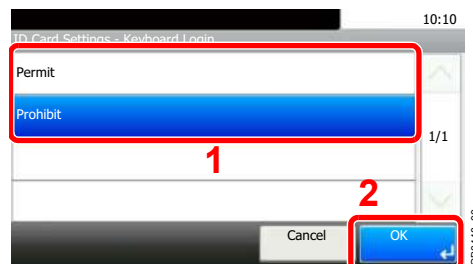

[Password Login]

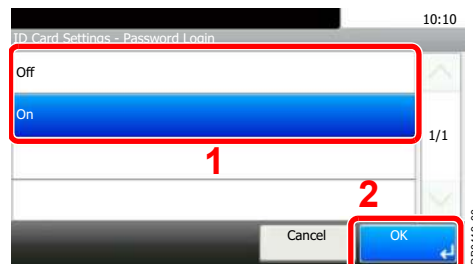

Simple Login

The simple login function allows users to log in simply by selecting a user name. Users must be registered in advance to use this functionality.

 For details, refer to *Adding a User on page 9-40*.

Simple Login Settings

Enable simple login.

1 Display the screen.

1 Referring to *User Login Settings on page 9-37*, display the screen.

2

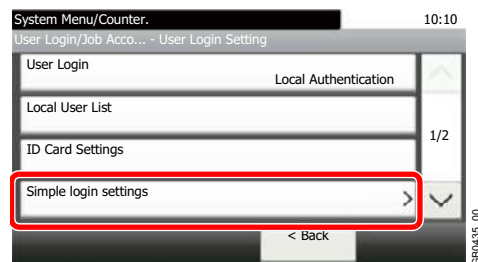

2 Enable simple login.

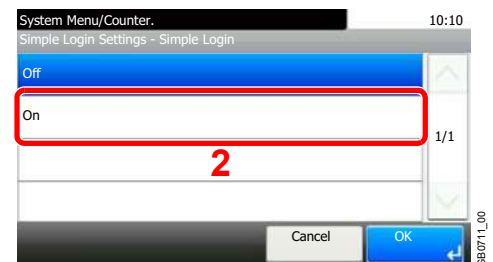
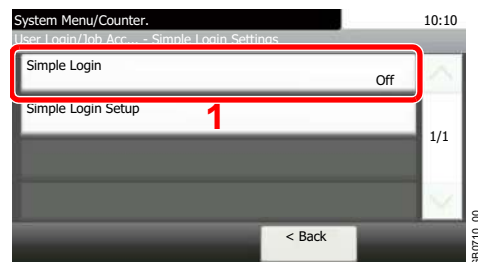

Register a User

Register users to use simple login. Up to 20 users can be registered.

The table below explains the user information to be registered.

Name	Set the user name to display on the Simple Login screen.
User	Select which registered users can use simple login.
Password Login	Set whether to require entry of a login password at login.
Icon	Select the icon to display on the Simple Login screen.

1 Display the screen.

1 Referring to *User Login Settings on page 9-37*, display the screen.

2

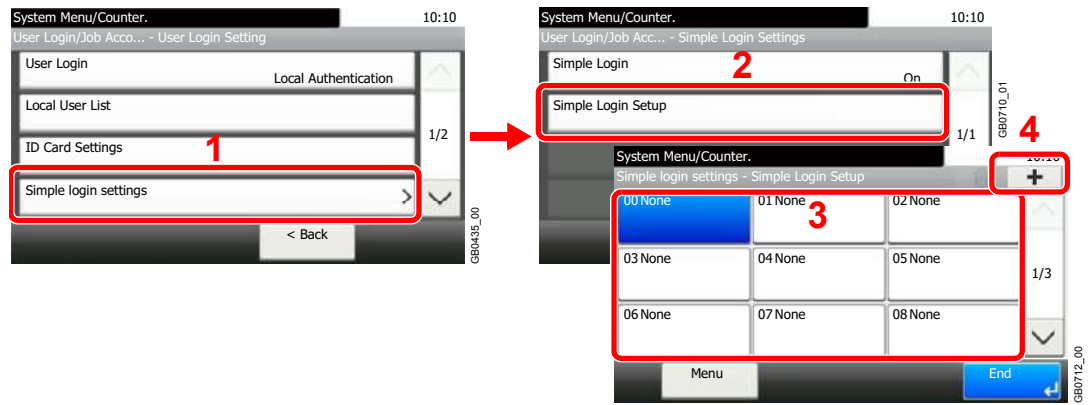

Select a key with no registered user, and press [+].

2 Enter the user information.

1 Select the type of user.

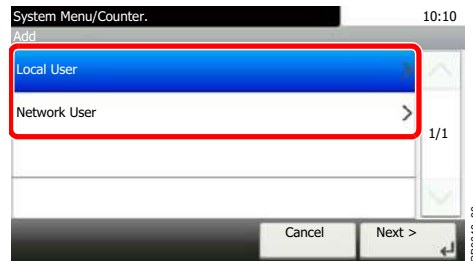

2 Select a user.

Local user

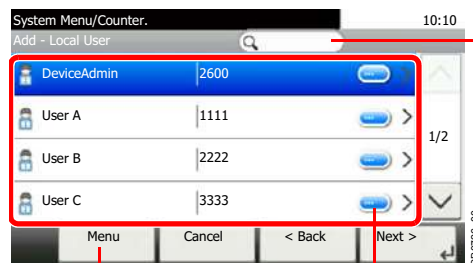

Allows you to search for a user and sorts results.

Displays details for individual users.

Network user

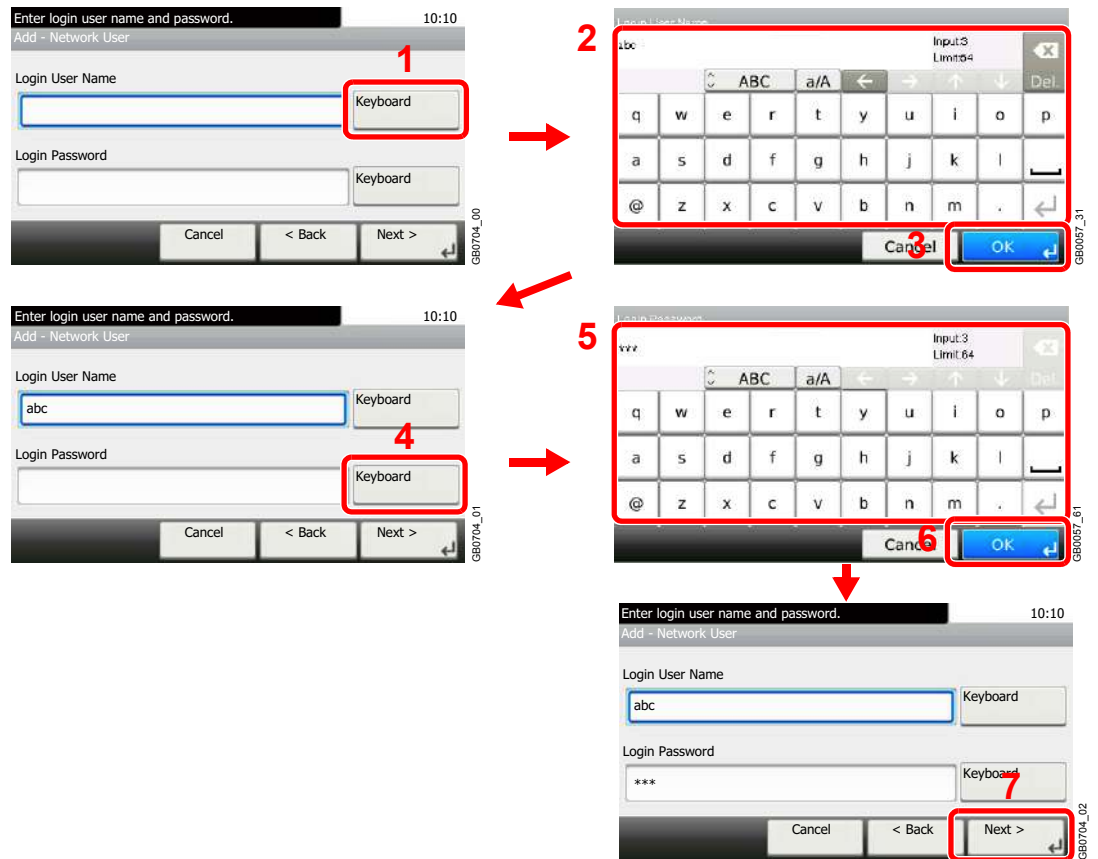

Enter the Login User Name and Login Password.

3 Enter the login user name to use with simple login.

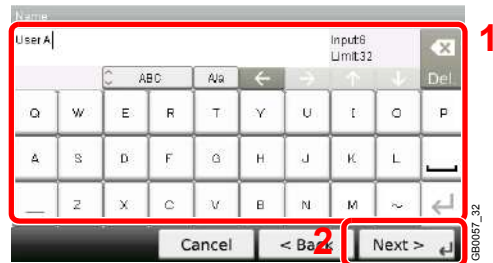

3 Check the settings.

Check the settings and change or add information as needed.

[Name]

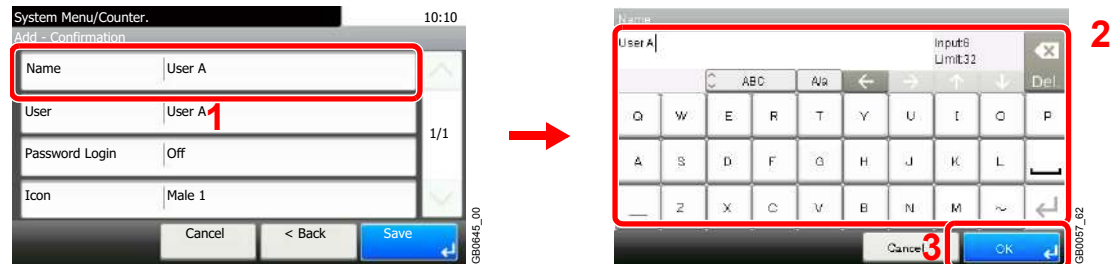

[User]

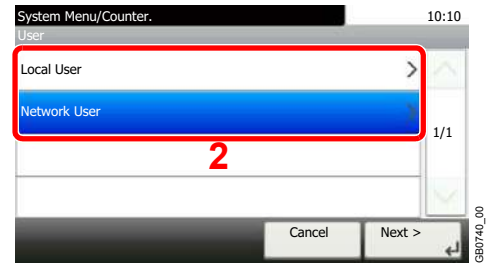
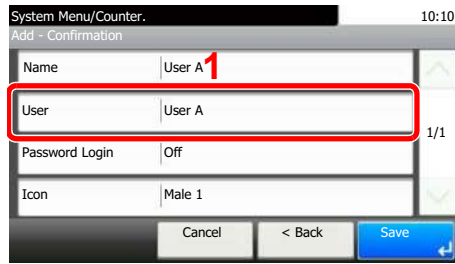

Select the user to use for simple logins from [Local User] or [Network User].

[Password Login]

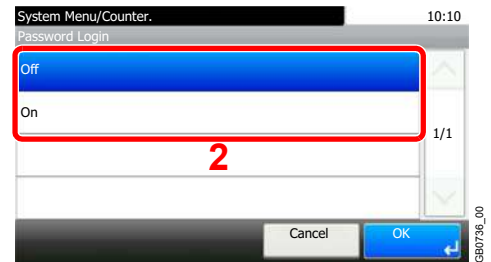
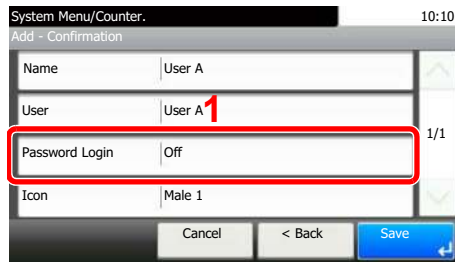

[Icon]

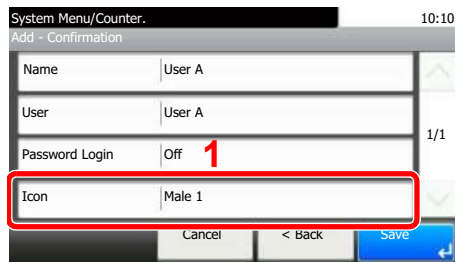

Use [∨] or [∧] to scroll up and down.

4 Register the user.

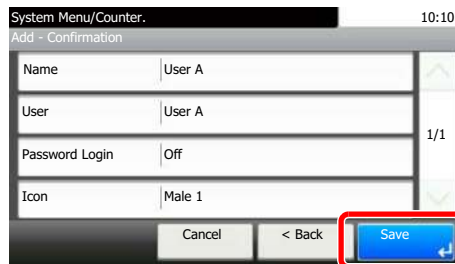

Editing and Deleting Users

User properties can be changed and users can be deleted.

1 Display the screen.

1 Referring to *User Login Settings* on page 9-37, display the screen.

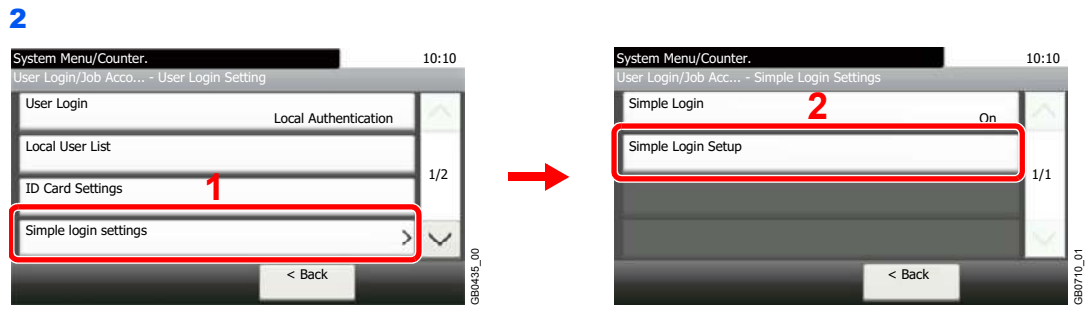

2 Edit or delete a user.

To edit a user

1 Select the user whose information you wish to edit and press [Menu] and then [Edit].

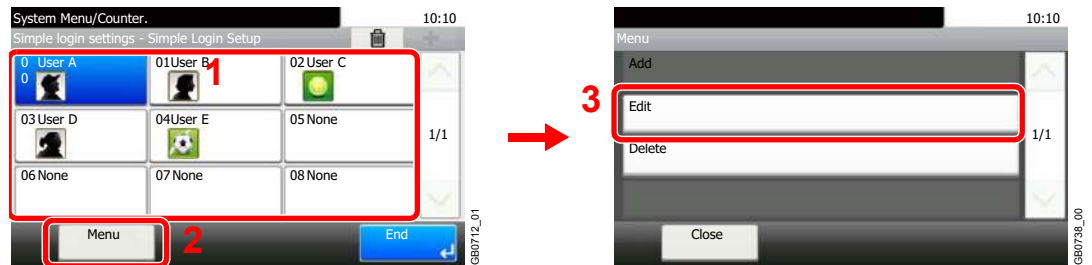

2 Edit the user.

[Name]

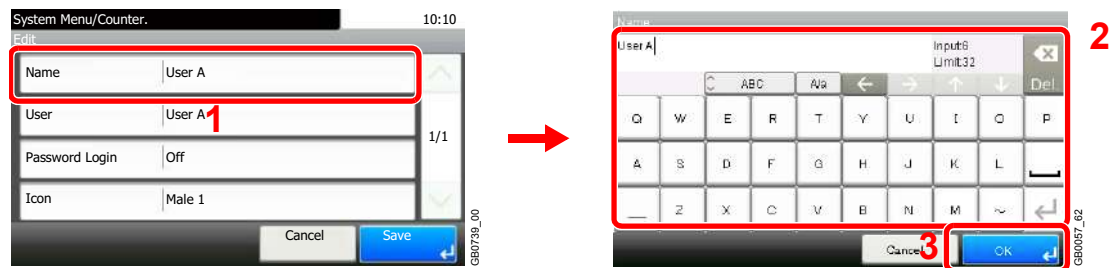

[User]

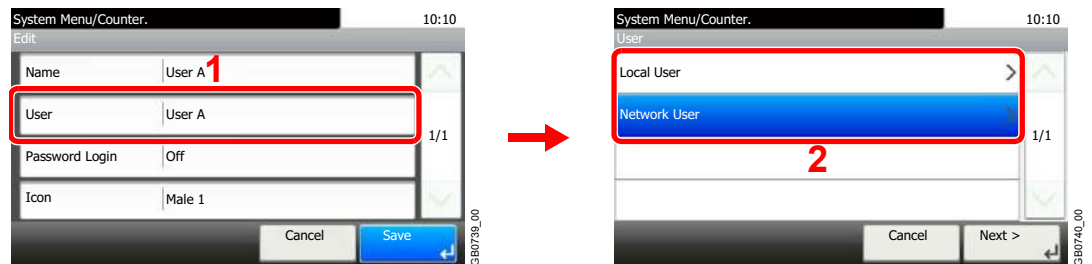

Select the user to use for simple logins from [Local User] or [Network User].

[Password Login]

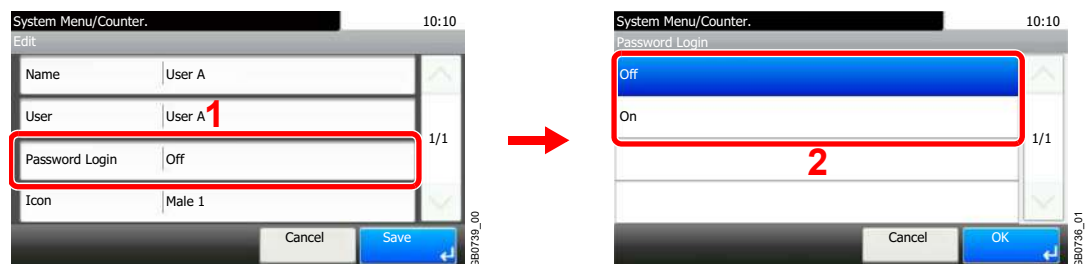

[Icon]

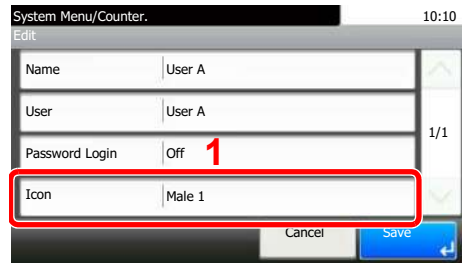

Use [∨] or [^] to scroll up and down.

3 Register the user.

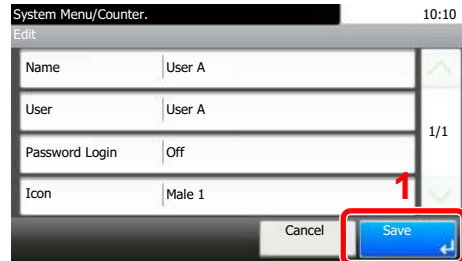

To delete



Select the user you wish to delete and press [(Delete)] (the trash can icon).



NOTE

You can also delete a user by selecting the name, pressing [Menu], and then pressing [Delete].

Group Authorization

Set restrictions of the machine usage by each individual group registered in the authentication server.

NOTE
To use the group authorization settings, [Network Authentication] must be selected for the authentication method and [NTLM] or [Kerberos] must be selected as the server type in *Enabling/Disabling User Login Administration on page 9-38*. Select [On] for LDAP in *Protocol Detail on page 9-21*.

Group Authorization Settings

Use the group authorization.

1 Display the screen.

1 Referring to *User Login Settings on page 9-37*, display the screen.

2

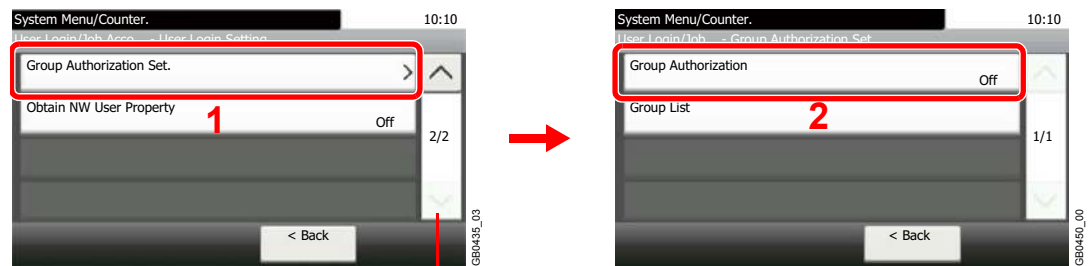

Use [∨] or [∧] to scroll up and down.

2 Select [On].

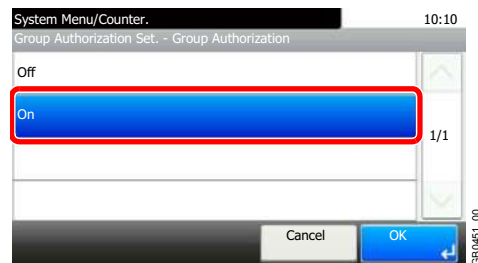

Add a Group

Register the groups that is restricted the machine usage. Up to 20 groups can be individually registered. Other users and groups belong to Others.

Group ID*	Enter the ID displayed on the group list (between 1 and 4294967295).
Group Name	Enter the name displayed on the group list (up to 32 characters).
Access Level	Select Administrator or User for group access privileges.
Printer	Select whether or not to reject usage of print functions for the printer.
Printer (Full Color)	Select whether or not to reject usage of full-color print functions for the printer.
Copy	Select whether or not to reject usage of copy functions.
Copy (Full Color)	Select whether or not to reject usage of full-color print functions for copies.
Send	Select whether or not to reject usage of the send functions.
FAX Transmission**	Select whether or not to reject usage of the FAX transmissions.

Storing in Box	Select whether or not to reject usage of storing in the document boxes.
Storing in Memory	Select whether or not to reject usage of storing in the removable memory.

* For Group ID, specify PrimaryGroupID assigned by ActiveDirectory of Windows. If you are using Windows Server 2008, check Attribute Editor tab of user properties. If you are using Windows Server 2000/2003, check ADSIEdit. ADSIEdit is a support tool included on the installation CD or DVD for Windows Server OS (under \SUPPORT\TOOLS).

** FAX functions are available only on products with the fax function installed.

1 Display the screen.

1 Referring to *User Login Settings* on page 9-37, display the screen.

2

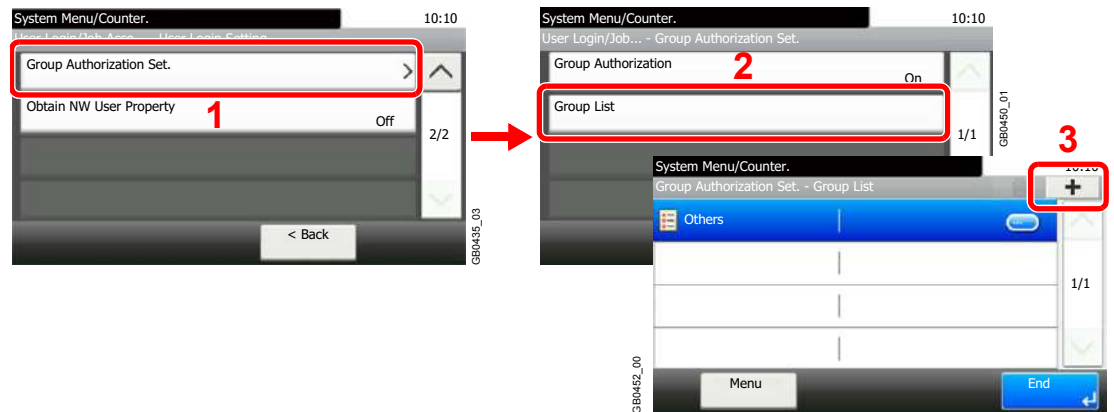

2 Enter the group information.

[Group ID]

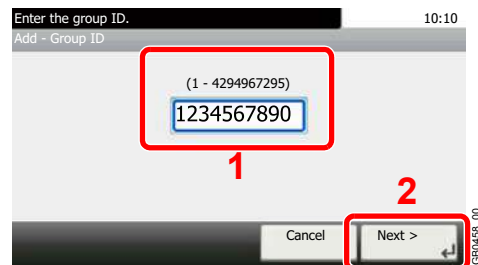

[Group Name]

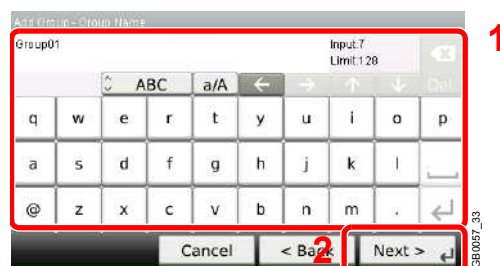

[Access Level]

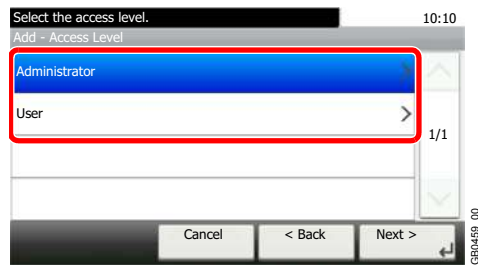

3 Check the settings.

Check the settings and change or add information as needed.

[Group ID]

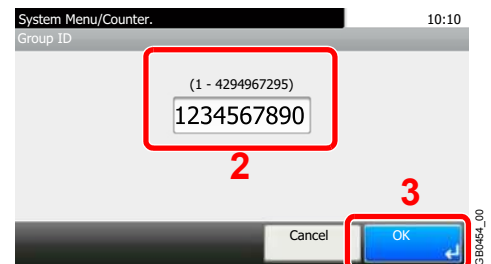
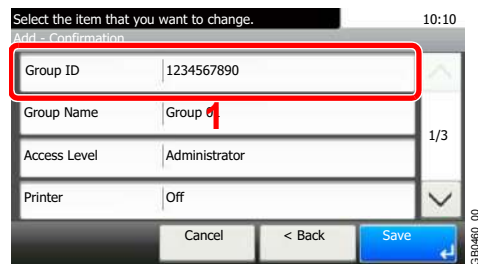

[Group Name]

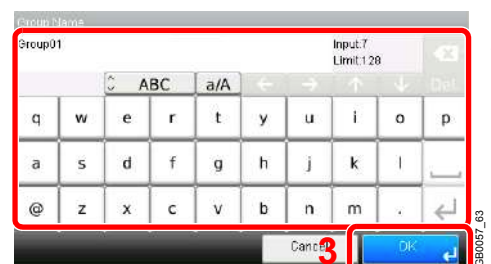
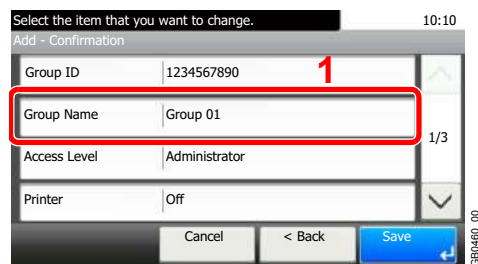

[Access Level]

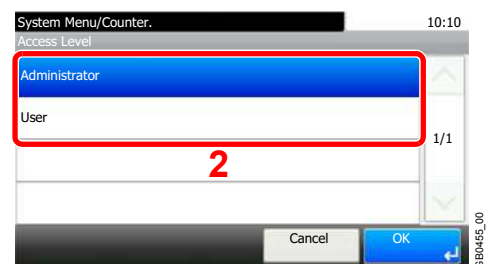
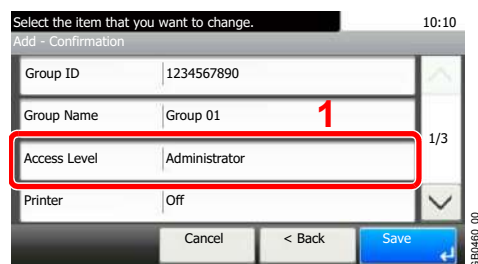

[Printer], [Printer (Full Color)], [Copy], [Copy (Full Color)], [Send], [FAX Transmission], [Storing in Box], [Storing in Memory]

Select the item that you want to change. 10:10
Add - Confirmation

Group ID	1234567890	
Group Name	Group 01	1/3
Access Level	Administrator	
Printer	Off	

Cancel < Back Save



System Menu/Counter. 10:10
Printer

Off	
Reject Usage	1/1

Cancel OK

Select the item that you want to change. 10:10
Add - Confirmation

Printer (Full Color)	Off	
Copy	Off	2/3
Copy (Full Color)	Off	
Send	Off	

Cancel < Back Save

Use [∨] or [∧] to scroll up and down.

Select the item that you want to change. 10:10
Add - Confirmation

FAX Transmission	Off	
Storing in Box	Off	3/3
Storing in Memory	Off	

Cancel < Back Save

Change the restrictions as needed.

4 Register the group.

Select the item that you want to change. 10:10
Add - Confirmation

Group ID	1234567890	
Group Name	Group 01	1/3
Access Level	Administrator	
Printer	Off	

Cancel < Back Save

Obtain Network User Property

Set the required information to obtain the network user property from the LDAP server.

 **NOTE**

To obtain the network user property from the LDAP server, [Network Authentication] must be selected for the authentication method and [NTLM] or [Kerberos] must be selected as the server type in *Enabling/Disabling User Login Administration on page 9-38*.

Server Name*	Enter the LDAP server name or the IP address (up to 64 characters).
Port	Set the LDAP port number or use the default port 389.
Name 1**	Enter the LDAP Attribute to obtain the user name to be displayed from the LDAP server (up to 32 characters).
Name 2***	
E-mail Address****	Enter the LDAP Attribute to obtain the e-mail address from the LDAP server (up to 128 characters).
Search Timeout	Set the amount of time to wait before time-out in seconds (from 5 to 255 seconds).

- * If using Active Directory of Windows, the server name may be same as the server name entered in the network authentication.
- ** If using Active Directory of Windows, **displayName** of Attribute may be used as *Name 1*.
- *** Name 2 can be left out. When you assign **displayName** in *Name 1* and **department** in *Name 2*, and if the value of **displayName** is "Mike Smith" and the value of **department** is "Sales" in Active Directory of Windows, the user name appears as *Mike Smith Sales*.
- **** If using Active Directory of Windows, **mail** of Attribute may be used as E-mail Address.

1 Display the screen.

1 Referring to *User Login Settings on page 9-37*, display the screen.

2

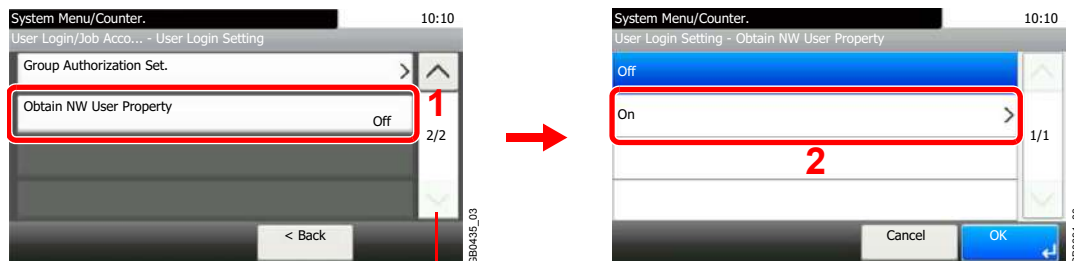

Use [∨] or [∧] to scroll up and down.

2 Configure the function.

[Server Name]



Up to 64 characters can be entered.

 Refer to *Character Entry Method on page 11-8* for details on entering characters.

[Port]

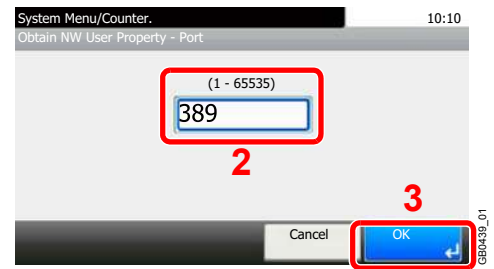
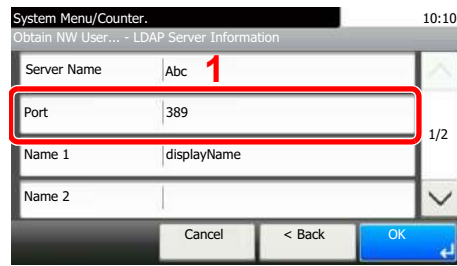

[Name 1] and [Name 2]

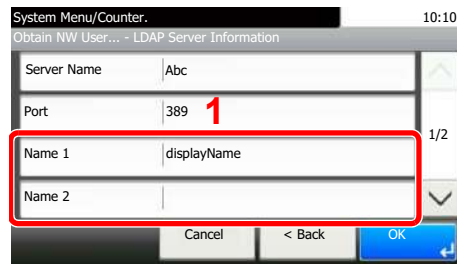

Up to 32 characters can be entered.

[Authentication Type]

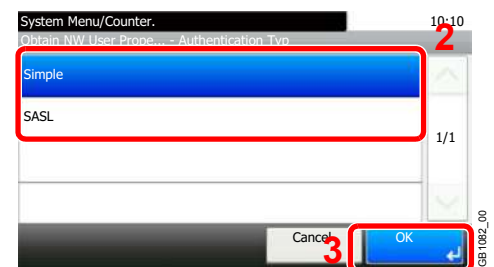
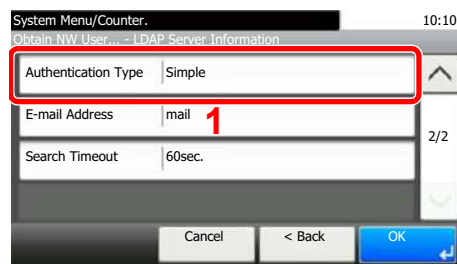

[Authentication Type] is displayed when selecting [Kerberos] as the Server Type.

[E-mail Address]

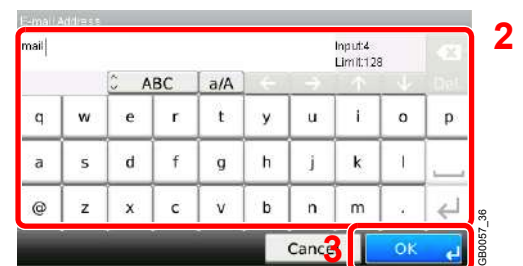
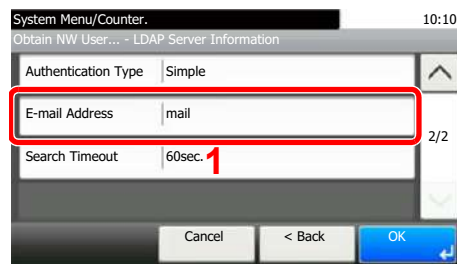

Up to 128 characters can be entered.

[Search Timeout]

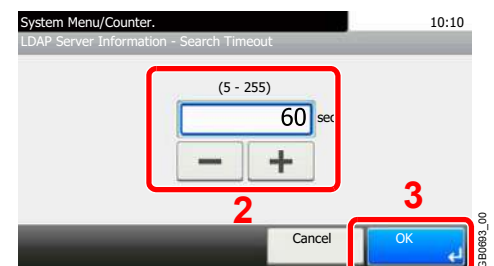
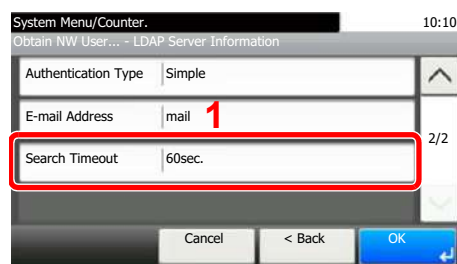

3 Press [OK].

Job Accounting

Job accounting Manages the copy/print count accumulated by individual accounts by assigning an ID to each account. Job accounting helps the following activities in business organizations.

- Manageability of up to 100 individual accounts.
- Availability for account IDs with as many as eight digits (between 0 and 99999999) for security.
- Integrated management of printing and scanning statistics through the use of an identical account ID.
- Tracking the print volume for each account and for all accounts combined.
- Restricting the print counter in one-page increments up to 9,999,999 copies.
- Resetting the print counter for each account or for all accounts combined.

First Job Accounting Setup

Follow these steps for the first job accounting setup. For details about the configuration method, refer to *Job Accounting Settings* on page 9-65.

1 Enable job accounting.

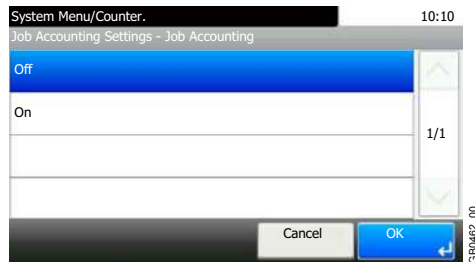

2 Add an account.

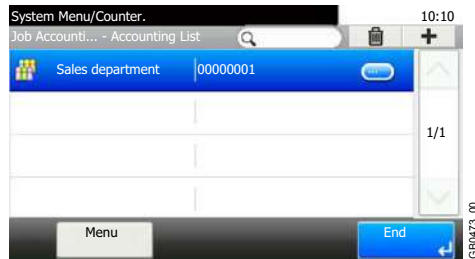

3 Log out.

Logout



4 Other users login for operations.



Job Accounting Settings

1 Display the screen.

◆ System Menu / Counter



1

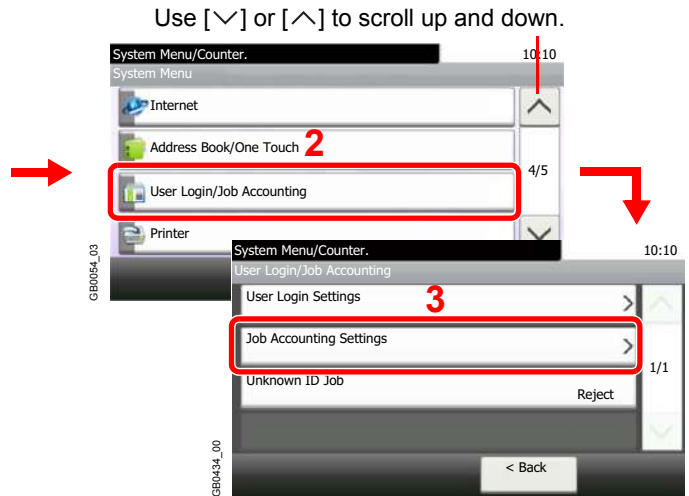

NOTE

You can only change the settings by logging in with administrator privileges. Refer to *Adding a User on page 9-40* for the default login user name and password.



2 Configure the function.

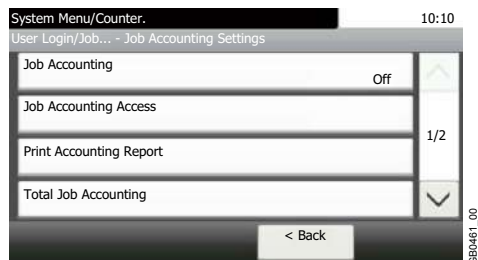

- Enabling/Disabling Job Accounting ▶ page 9-66
- Login/Logout ▶ page 9-67
- Job Accounting Access ▶ page 9-68
- Adding an Account ▶ page 9-69
- Editing and Deleting Accounts ▶ page 9-71
- Restricting the Use of the Machine ▶ page 9-73
- Counting the Number of Pages Printed ▶ page 9-75
- Printing an Accounting Report ▶ page 9-77
- Job Accounting Default Setting ▶ page 9-78
- Unknown Login User Name Job ▶ page 9-79

Enabling/Disabling Job Accounting

Enable job accounting.

1 Display the screen.

1 Referring to *Job Accounting Settings* on page 9-65, display the screen.

2

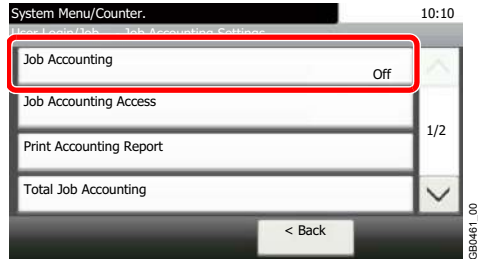

2 Enable job accounting.

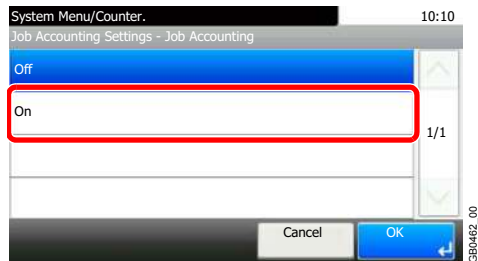

NOTE

When the display returns to the System Menu default screen, logout is automatically executed and the screen to enter the Account ID appears. To continue the operation, enter the Account ID.

Login/Logout

If job accounting is enabled, an account ID entry screen appears each time you use this machine.

Login

1 Enter the account ID.

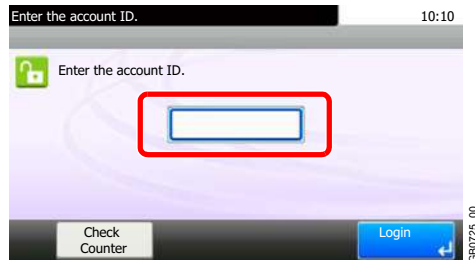

If this screen is displayed during operations, enter the account ID.



NOTE

If you entered a wrong character, press the **Clear** key and enter the account ID again.

If the entered account ID does not match the registered ID, a warning beep will sound and login will fail. Enter the correct account ID.

By pressing [Check Counter], you can refer to the number of pages printed and the number of pages scanned.

2 Log in.



When the screen to enter the login user name and password appears

If user login administration is enabled, the screen to enter the login user name and password appears. Enter a login user name and password to login. (Refer to *Login/Logout on page 3-15*.) If the user has already registered the account information, the account ID entry would be skipped. (Refer to *Adding a User on page 9-40*.)

Logout

When the operations are complete, press the **Logout** key to return to the account ID entry screen.

Logout



Job Accounting Access

Set the job accounting access.

1 Display the screen.

1 Referring to *Job Accounting Settings* on page 9-65, display the screen.

2

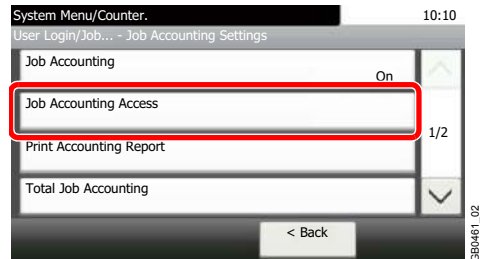

2 Configure the settings.

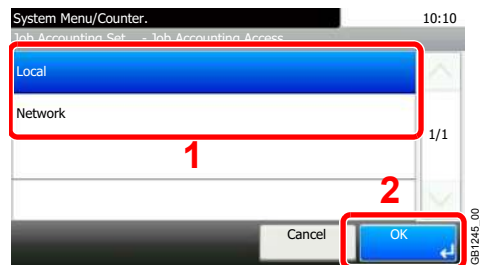

NOTE

To select [Network], network authentication must be enabled and [Ext.] must be selected for server type.



Refer to *Enabling/Disabling User Login Administration* on page 9-38.

Adding an Account

This section explains how to add a new account. The following entries are required.

Account Name	Enter the account name (up to 32 characters).
Account ID	Enter the account ID as many as eight digits (between 0 and 99999999).
Restriction	This Prohibits printing/scanning or restricts the number of sheets to load. Refer to <i>Restricting the Use of the Machine on page 9-73</i> .



NOTE

Any account ID that has already registered cannot be used. Enter any other account ID.

1 Display the screen.

1 Referring to *Job Accounting Settings on page 9-65*, display the screen.

2

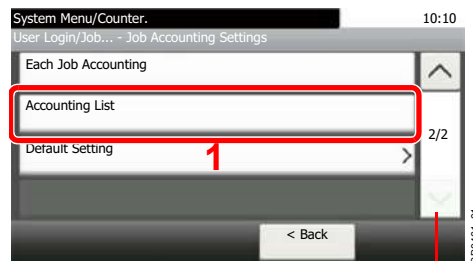

Use [∨] or [∧] to scroll up and down.



2 Enter the account information.

[Account Name]

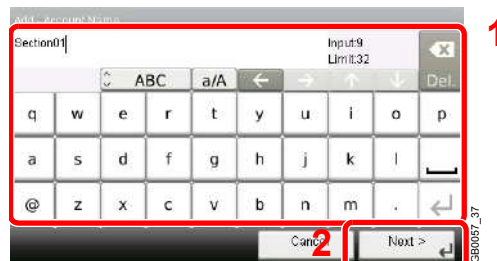

[Account ID]

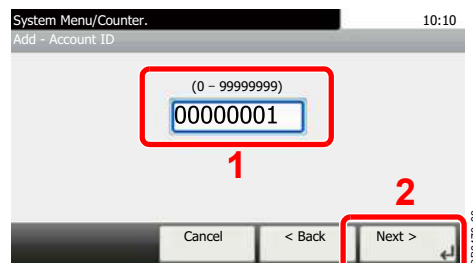

3 Check the settings.

Check the settings and change or add information as needed.

[Account Name]

Select the item that you want to change. 10:10
Add - Confirmation

Account Name	Section 01	
Account ID	00000001	1/2
Print (Total)	Off	
Print (Full Color)	Off	

Cancel < Back Save



Section01 Input 9 Limit.32

ABC a/A

q w e r t y u i o p
a s d f g h j k l
@ z x c v b n m .

Cancel OK



Refer to *Character Entry Method* on page 11-8 for details on entering characters.

[Account ID]

Select the item that you want to change. 10:10
Add - Confirmation

Account Name	Section 01	
Account ID	00000001	1/2
Print (Total)	Off	
Print (Full Color)	Off	

Cancel < Back Save



System Menu/Counter. 10:10
Account ID

(0 - 99999999)

00000001

Cancel OK

Restrictions

Select the item that you want to change. 10:10
Add - Confirmation

Account Name	Section 01	
Account ID	00000001	1/2
Print (Total)	Off	
Print (Full Color)	Off	

Cancel < Back Save



System Menu/Counter. 10:10
Print (Total)

Off

Counter Limit >

Reject Usage

Cancel OK

Select the item that you want to change. 10:10
Add - Confirmation

Scan (Others)	Off	
FAX Transmission	Off	2/2

Cancel < Back Save

Use [∨] or [∧] to scroll up and down.



For details, refer to *Restricting the Use of the Machine* on page 9-73.

4 Register the account.

Select the item that you want to change. 10:10
Add - Confirmation

Account Name	Section 01	
Account ID	00000001	1/2
Print (Total)	Off	
Print (Full Color)	Off	

Cancel < Back Save

Editing and Deleting Accounts

This changes the registered account information or deletes the account.

1 Display the screen.

1 Referring to *Job Accounting Settings* on page 9-65, display the screen.

2

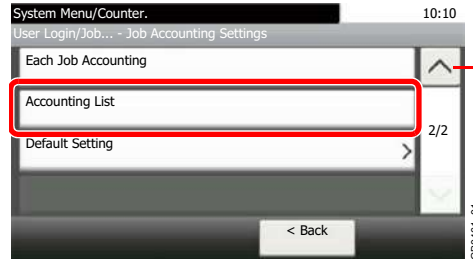

Use [∨] or [∧] to scroll up and down.

2 Edit or delete an account.

To edit an account

1 Press [...] for the account name you wish to edit.

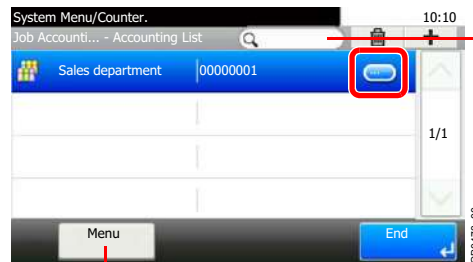

Searches by account name.

Allows you to search for an account name and sorts results.

You can specify an account name by account ID by pressing the **Quick No. Search** key.

2 Edit the account.

[Account Name]

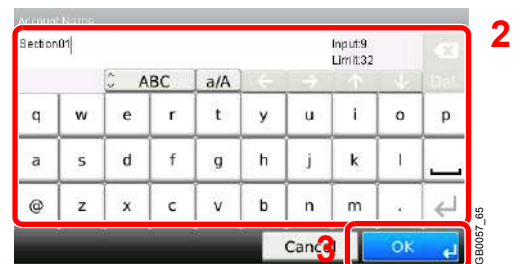
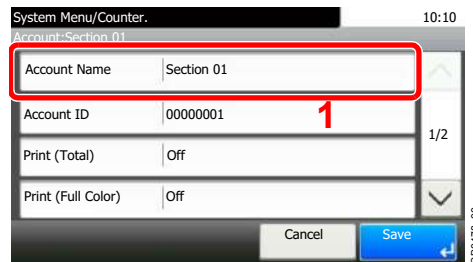

[Account ID]

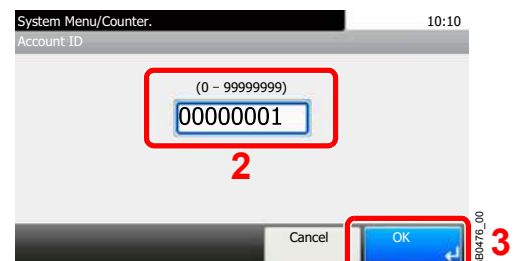
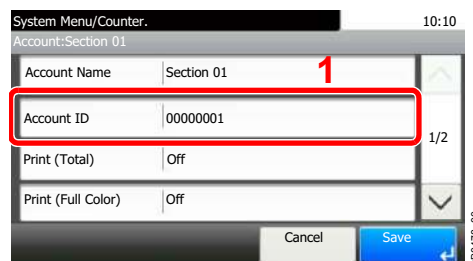

Restriction

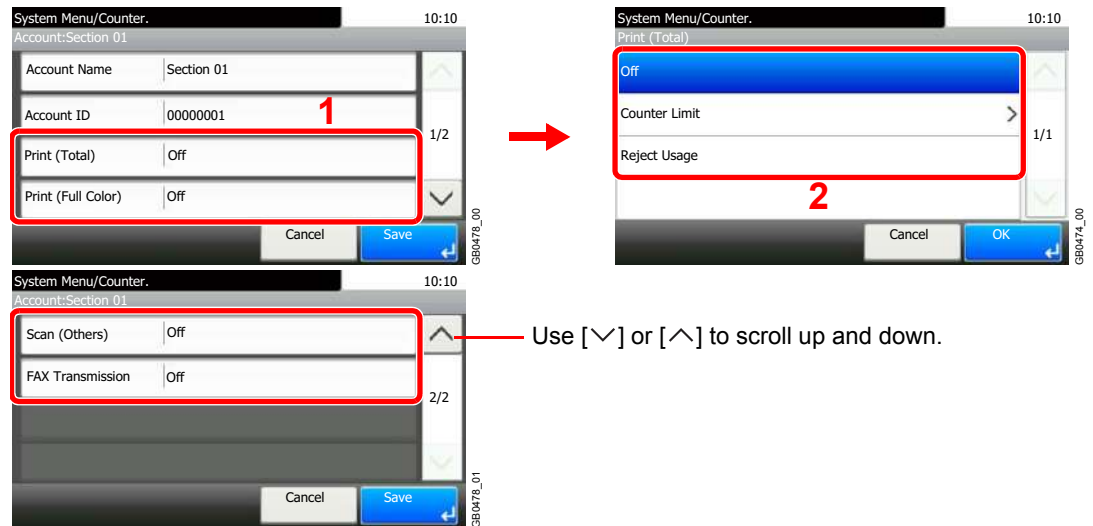

 For details, refer to *Restricting the Use of the Machine* on page 9-73.

3 Register the account.

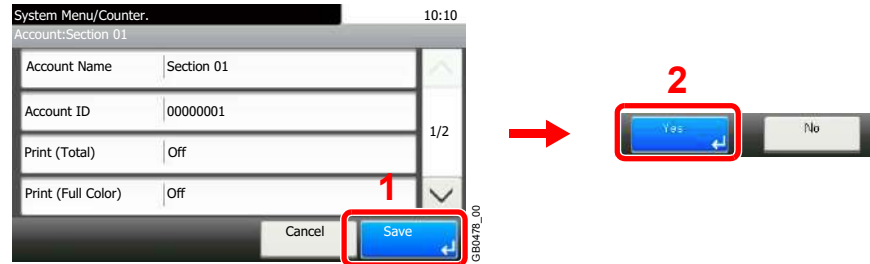

To delete



Select the account name you wish to delete and press [(Delete)] (the trash can icon).

Restricting the Use of the Machine

This section explains how to restrict the use of the machine by account or the number of pages available.

Set when *Adding an Account* (see page 9-69) or *Editing and Deleting Accounts* (see page 9-71).

The items that can be restricted differ depending on whether [Individual] or [Total] is selected for *Copier/Printer Count* on page 9-78.

Restriction Items

[Individual] selected for Copier/Printer Count

Copy (Total)	Limits the total number of pages used for full-color and black and white copying.
Copy (Full Color)	Limits the number of pages used for full-color copying.
Printer (Total)	Limits the total number of pages used for color and black and white printing.
Printer (Full Color)	Limits the number of pages used for color printing.
Scan (Others)	Limits the number of pages scanned (excludes copying).
FAX Transmission*	Limits the number of pages sent by fax.

* FAX functions are available only on products with the fax function installed.

[Total] selected for Copier/Printer Count

Print (Total)	Limits the total number of pages used for copying and printing.
Print (Full Color)	Limits the number of pages used for full-color printing.
Scan (Others)	Limits the number of pages scanned (excludes copying).
FAX Transmission*	Limits the number of pages sent by fax.

* FAX functions are available only on products with the fax function installed.

Applying Restriction

Off	No restriction given.
Counter Limit	Restricts the print counter in one-page increments up to 9,999,999 pages.
Reject Usage	Restriction is applied.

 For details on the machine behaves when the counter has reached the limit of restriction, refer to *Apply Limit* on page 9-78.

1 Select the item to limit.

[Total] selected for Copier/Printer Count

Select the item that you want to change. 10:10
Add - Confirmation

Account Name	Section 01	
Account ID	00000001	
Print (Total)	Off	1/2
Print (Full Color)	Off	

Cancel < Back Save

GB0480_00

Use [∨] or [∧] to scroll up and down.

Select the item that you want to change. 10:10
Add - Confirmation

Scan (Others)	Off	
FAX Transmission	Off	2/2

Cancel < Back Save

GB0480_01

[Individual] selected for Copier/Printer Count

Select the item that you want to change. 10:10
Add - Confirmation

Account Name	Section 01	
Account ID	00000001	
Copy (Total)	Off	1/2
Copy (Full Color)	Off	

Cancel < Back Save

GB0480_02

Use [∨] or [∧] to scroll up and down.

Select the item that you want to change. 10:10
Add - Confirmation

Printer (Total)	Off	
Printer (Full Color)	Off	2/2
Scan (Others)	Off	
FAX Transmission	Off	

Cancel < Back Save

GB0480_03

2 Select a restriction method.

System Menu/Counter. 10:10
Print (Total)

Off	
Counter Limit	>
Reject Usage	

Cancel OK

GB0474_00

If [Counter Limit] is selected, press [+], [-] or numeric keys to select the number of pages, and press [OK].

Counting the Number of Pages Printed

This counts the number of pages printed. Counts are classified into Total Job Accounting and Each Job Accounting. A new count can also be started after resetting the count data which was stored for a certain period of time. Types of the counts are as follows.

Printed Pages	<p>Displays the number of pages copied and printed, and the total number of pages used. You can also use [by Duplex] and [by Combine] to check the number of pages used.</p> <ul style="list-style-type: none"> For copying, you can check the pages used for black and white and full-color copying as well as the total pages used. For printing, you can check the pages used for black and white and full-color printing as well as the total pages used. You can use [by Duplex] to check the number of pages used in Duplex (1-sided) mode, Duplex (2-sided) mode and the total for both. You can use [by Combine] to check the number of pages used in Combine (None) mode, Combine (2 in 1) mode, Combine (4 in 1) mode and the total for all three.
Scanned Pages	Displays the number of pages scanned for copying, faxing* and other functions, as well as the total number of pages scanned.
FAX Transmission Pages*	Displays the number of pages faxed.
FAX Transmission Time*	Displays the total duration of fax transmissions.

* FAX functions are available only on products with the fax function installed.

1 Display the screen.

1 Referring to *Job Accounting Settings* on page 9-65, display the screen.

2

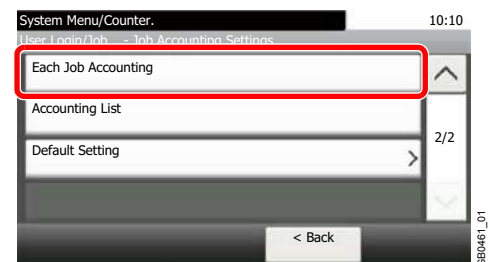
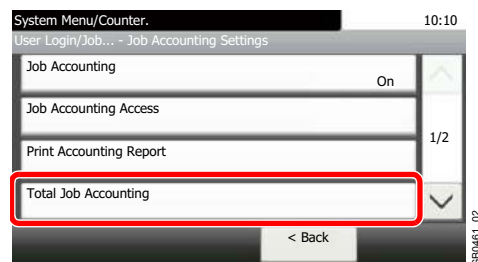

To count the number of pages for all account, select [Total Job Accounting]. To count the number of pages by account, select [Each Job Accounting].

Searches by account name.

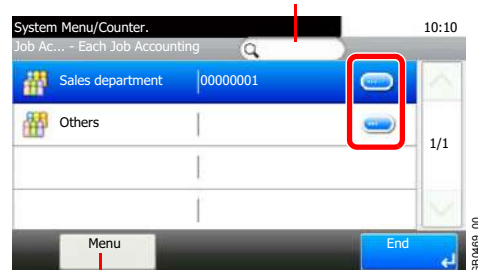

Allows you to search for an account name and sorts results.

To count the number of pages by account name, press [...] for the account name whose usage you wish to view.

2 View the number of pages.

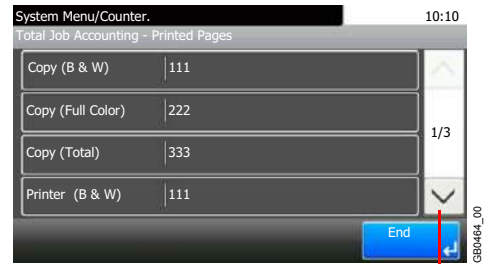
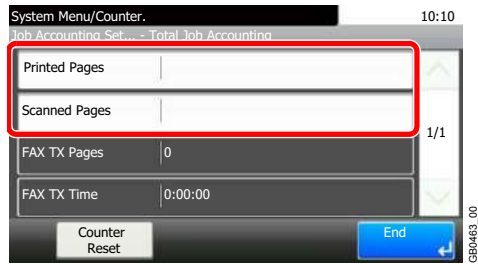

Use [∨] or [∧] to scroll up and down.

To reset the counter

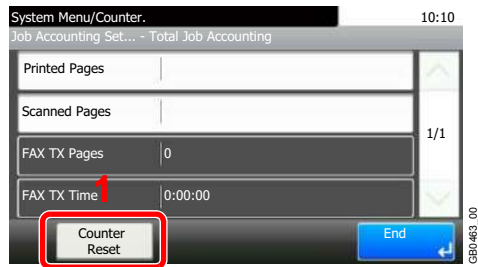

Printing an Accounting Report

Total pages counted at all relevant accounts can be printed as an accounting report. Reports have different formats depending on how the count of copiers and printers is administered.

Copier/Printer Count	Format	
When [Total] is selected for Copier/Printer Count	Print (Total)	Total number of pages used for copying and printing Total number of pages used for full-color copying and printing Total number of pages used for black-and-white copying and printing
When [Individual] is selected for Copier/Printer Count	Copy	Total number of pages used for copying Total number of pages used for full-color copying Total number of pages used for black-and-white copying
	Print	Total number of pages used for printing Total number of pages used for full-color printing Total number of pages used for black-and-white printing
Shared statistics	Scan	Total number of pages scanned
		Total number of pages scanned for copying
		Total number of pages faxed
		Total number of other pages scanned
	Fax	Total number of pages received
		Total number of pages sent
		Total duration of fax transmissions
	Other	Total number of duplex pages printed
		Total number of 1-sided pages printed
		Total number of combine (2 in 1) pages
Total number of combine (4 in 1) pages		
Total number of non-combine pages printed		

1 Prepare paper.

Check that Letter or A4 paper is loaded in the cassette.

2 Display the screen.

Referring to *Job Accounting Settings* on page 9-65, display the screen.

3 Print reports.

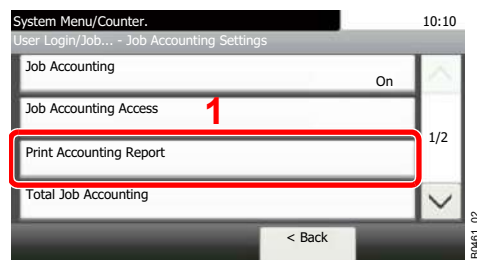

Job Accounting Default Setting

Sets default settings related to job accounting.

Display the screen.

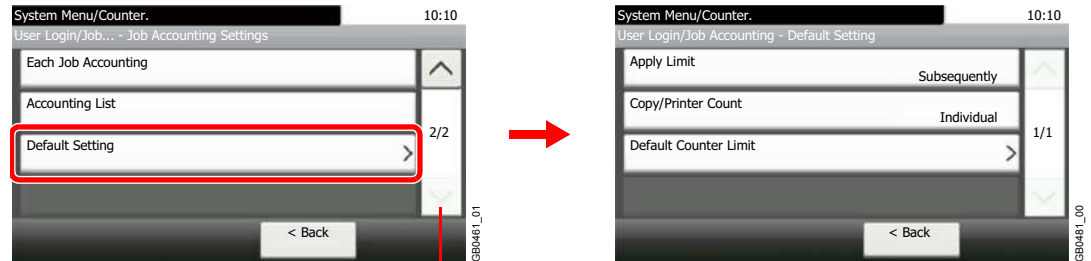

1 Referring to *Job Accounting Settings* on page 9-65, display the screen.

2



Use [∨] or [∧] to scroll up and down.

Setting Items

Item	Description
Apply Limit	<p>This specifies how the machine behaves when the counter has reached the limit of restriction.</p> <p>Value</p> <p>Immediately*: Job stops when the counter reaches its limit.</p> <p>Subsequently: Printing/scanning of the job continues but the subsequent job will be rejected.</p> <p>Alert Only: Job continues while displaying an alert message.</p>
Copier/Printer Count	<p>You can select how the copying and printing page counts are shown - either the total of both or each of copying and printing individually. The selection may influence restriction on the count and count method.</p> <p> Refer to <i>Restricting the Use of the Machine</i> on page 9-73, <i>Counting the Number of Pages Printed</i> on page 9-75 and <i>Printing an Accounting Report</i> on page 9-77 for details.</p> <p>Value: Total, Individual</p>
Default Counter Limit	<p>When you add a new account, you can change the default restrictions on the number of pages used.</p> <p> Refer to <i>Restricting the Use of the Machine</i> on page 9-73.</p> <p>Value: 1 to 9,999,999 in 1-sheet increments</p>

* The next job will be prohibited in sending or in storing in the box.

Unknown Login User Name Job

This specifies the behavior for handling the jobs sent with unknown login user names or User ID (i.e. unsent IDs). If the User Login is set to invalid and Job Accounting is set to valid, follow the procedure when the Account ID is unknown.

1 Display the screen.

◆ System Menu / Counter

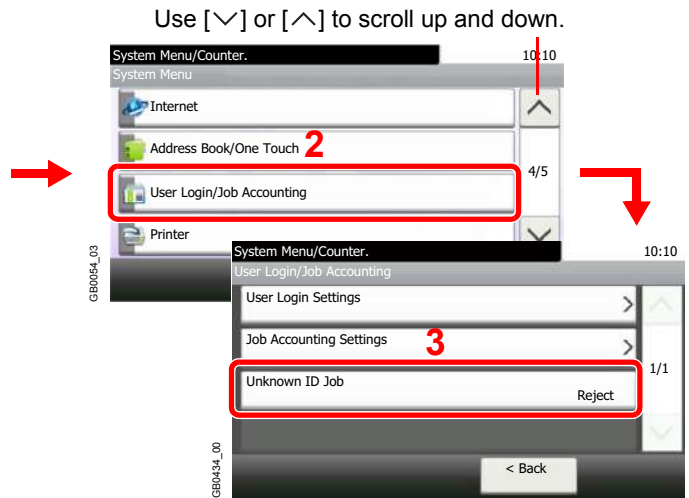
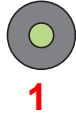

2 Select the function.

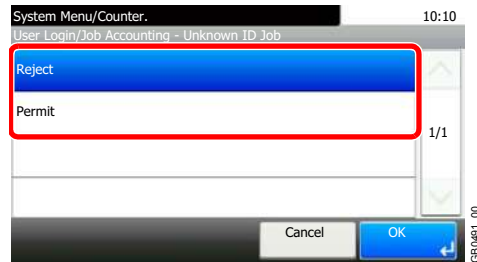

10 Troubleshooting

This chapter explains the following topics:

Toner Container Replacement	10-2
Waste Toner Box Replacement	10-4
Cleaning	10-6
Glass Platen	10-6
Document Processor	10-6
Paper Transfer Unit	10-7
Solving Malfunctions	10-8
Responding to Error Messages	10-13
Clearing Paper Jams	10-22
Paper Jam Location	10-22
Multi Purpose Tray	10-23
Cassette	10-23
Paper Feeder	10-24
Inside the Machine	10-24
Document Processor	10-26

Toner Container Replacement

When the touch panel displays *Toner is empty.*, replace the toner.

CAUTION

Do not attempt to incinerate the toner container or the waste toner box. Dangerous sparks may cause burns.

Installation procedures of the toner container is same for every color. The procedures here represent the cyan toner container.

1 Remove the old toner container.

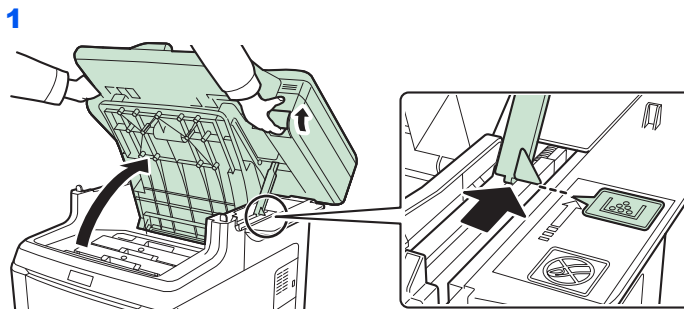

IMPORTANT

To prevent toppling, the top cover and document processor cannot be opened at the same time.

Open the top cover to the position shown. If the tray is not opened to this position, it will not be possible to install the toner container.

2

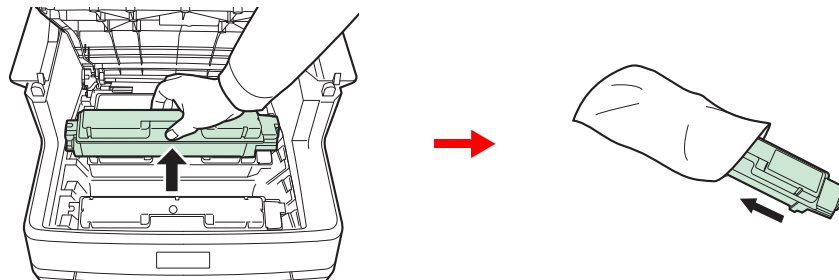

2 Prepare the new toner container.

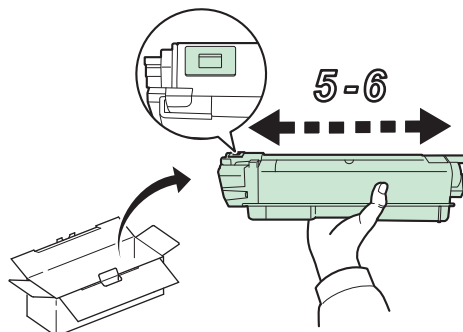

3 Install the new toner container.

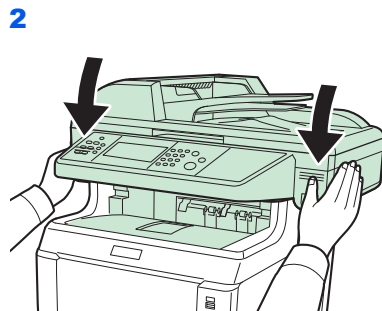
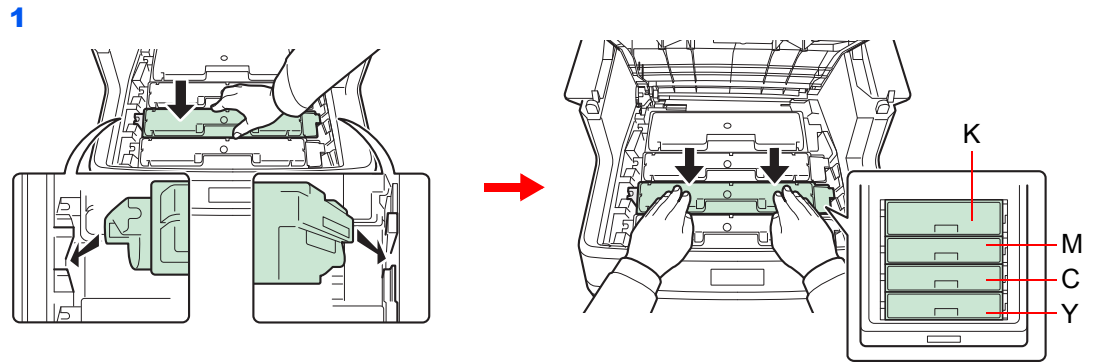

 **IMPORTANT**

When closing the top cover, be careful not to pinch your fingers.

Waste Toner Box Replacement

When the touch panel displays *Check waste toner box.*, replace the waste toner box.

1 Remove the old waste toner box.

1

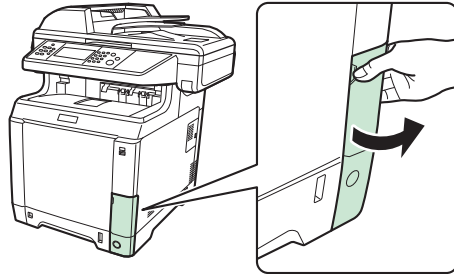

2

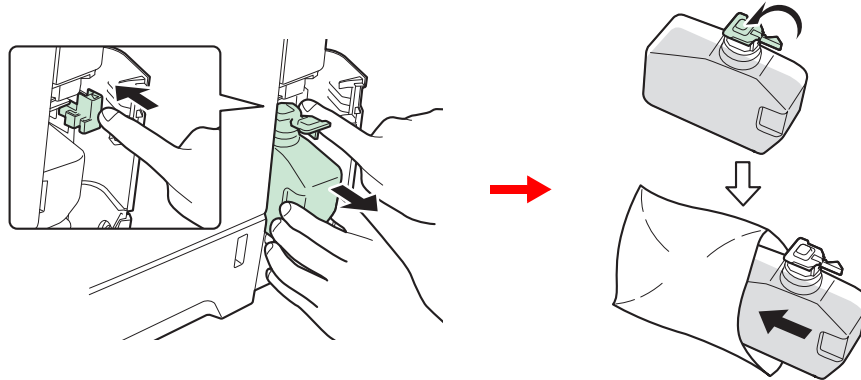

✔ IMPORTANT

Remove the waste toner box as gently as possible so as not to scatter the toner inside. Do not let the opening of the waste toner box face downward.

2 Install the new waste toner box.

1

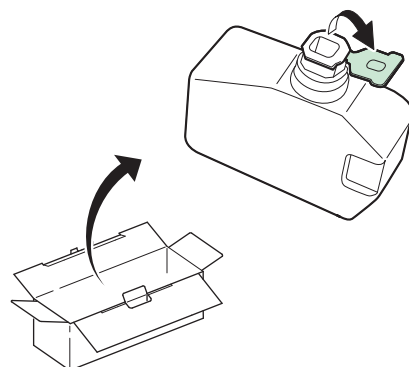

2

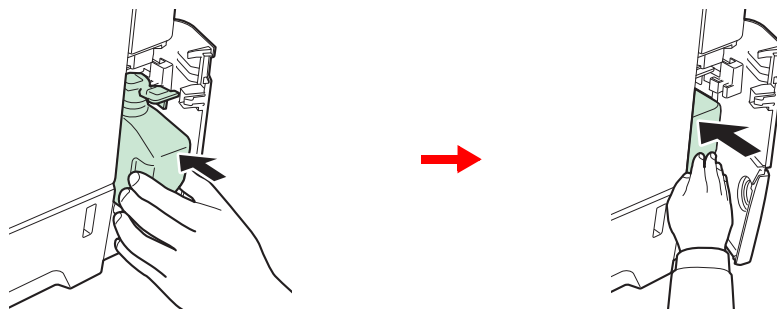

3

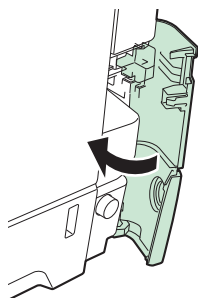

After replacing the toner containers and the waste toner box, clean the paper transfer unit. For instructions, refer to *Cleaning* on page 10-6.

Cleaning

Clean the machine regularly to ensure optimum output quality.

CAUTION

For safety, always unplug the power cord before cleaning the machine.

Glass Platen

Wipe the inside of the document processor and the glass platen with a soft cloth dampened with alcohol or mild detergent.

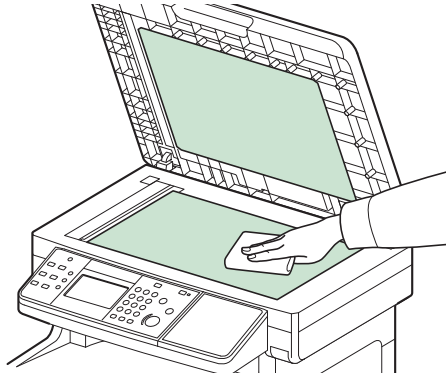

NOTE

Do not use organic solvents or other strong chemicals.

Document Processor

If black streaks or dirt appears in copies when using the document processor, clean the slit glass with the supplied cleaning cloth.



NOTE

Wipe the slit glasses with the dry accessory cloth. Do not use water, soap or solvents for cleaning.

1 Wipe the slit glass.

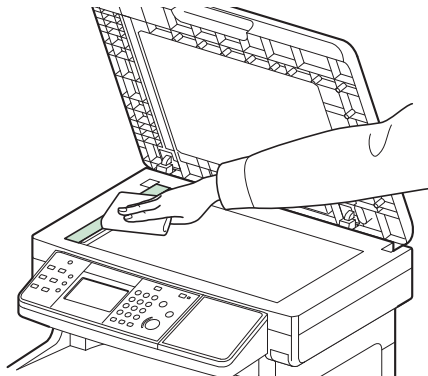

2 Wipe the white guide.

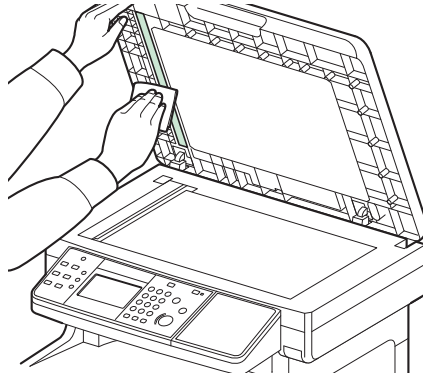

Paper Transfer Unit

The paper transfer unit should be cleaned each time the toner container and waste toner box are replaced. To maintain optimum print quality, it is also recommended that the inside of the machine be cleaned once a month as well as when the toner container is replaced. It should also be cleaned if streaking or lines appear on printed copies, or if printouts appear faint or blurred.

CAUTION

Some parts are very hot inside the machine. Exercise caution as there is a risk of burn injury.

1 Open the rear cover.

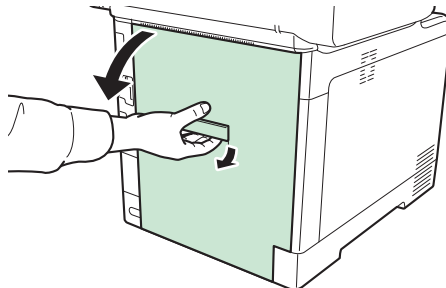

2 Clean the paper transfer unit.

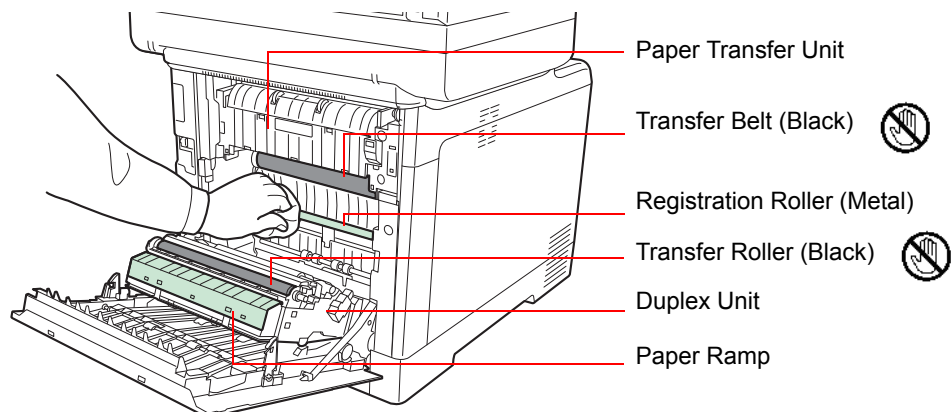

Wipe away the paper dust on the registration roller and the paper ramp using the cloth.

IMPORTANT



Be careful not to touch the black transfer roller and black transfer belt during cleaning as this may adversely affect print quality.

Solving Malfunctions

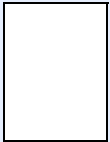

The table below provides general guidelines for problem solving.

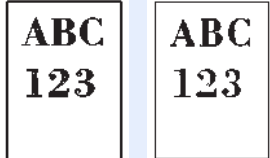
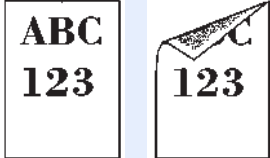
If a problem occurs with your machine, look into the checkpoints and perform procedures indicated on the following pages. If the problem persists, contact your Service Representative.

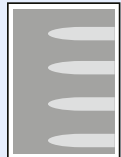
Symptom	Checkpoints	Corrective Actions	Reference Page
An application does not start.	Is the Auto Panel Reset time short?	Set the Auto Panel Reset time to 30 seconds or more.	9-27
The touch panel does not respond when the main power switch is turned on.	Is the machine plugged in?	Plug the power cord into an AC outlet.	2-11
Pressing the Start key does not produce copies.	Is there a message on the touch panel?	Determine the appropriate response to the message and respond accordingly.	10-13
	Is the machine in Sleep mode?	Press the Energy Saver key to recover the machine from Sleep mode. The machine will be ready to copy within 20 seconds.	2-28
Cannot print.	Is the machine plugged in?	Plug the power cord into an AC outlet.	2-11
	Is the machine powered on?	Turn on the main power switch.	2-13
	Are the printer cable and network cable connected?	Connect the correct printer cable and network cable securely.	2-10
	Was the machine powered on before the printer cable was connected?	Power on the machine after connecting the printer cable.	2-10
	Is the print job paused?	Resume printing.	8-3
Blank sheets are ejected. 	Are the originals loaded correctly?	When placing originals on the platen, place them face-down and align them with the original size indicator plates.	3-10
		When placing originals in the document processor, place them face-up.	3-12
	—	Check that the application software is correctly operated.	—
Paper often jams.	Is the paper loaded correctly?	Load the paper correctly.	3-2
	Is the paper of the supported type? Is it in good condition?	Remove the paper, turn it over, and reload it.	3-2
	Is the paper curled, folded or wrinkled?	Replace the paper with new paper.	3-2
	Are there any loose scraps or jammed paper in the machine?	Remove any jammed paper.	10-22
Printouts are wrinkled or curled.	Is the paper damp?	Replace the paper with new paper.	3-2
Documents are printed improperly.	Are the application software settings at the PC set properly?	Check that the printer driver and application software settings are set properly.	—
Cannot print with USB memory. USB memory not recognized.	Is the USB host blocked?	Select [Unblock] in the USB host settings.	9-26
	—	Check that the USB memory is securely plugged into the machine.	—

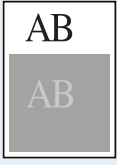
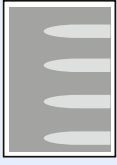
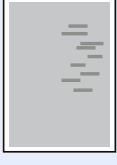
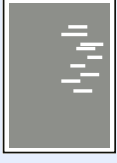
Symptom	Checkpoints	Corrective Actions	Reference Page
Printouts are too light. 	Is the paper damp?	Replace the paper with new paper.	3-2
	Have you changed the density?	Select appropriate density level.	3-43, 9-28
	Is the toner distributed evenly within the toner container?	Shake the toner container from side to side several times.	10-2
	Is there a message indicating the addition of toner?	Replace the toner container.	10-2
	Is EcoPrint mode enabled?	Disable EcoPrint mode.	3-46
	—	Run [Laser Scanner Cleaning].	9-29
	—	Make sure the media type setting is correct the paper being used.	9-7
Printouts are too dark.	Have you changed the density?	Select appropriate density level.	3-43, 9-28
	—	Run [Calibration].	9-29
The background density is obtrusive.	—	Carry out [Background Density Adjustment].	3-48
Dirt on the print side of the paper.	Is the platen or the document processor dirty?	Clean the platen or the document processor.	10-6
	—	Run [Laser Scanner Cleaning].	9-29
Dirt on the top edge or back of the paper. 	Is the paper transfer unit dirty?	Clean the transfer unit.	10-7
Printouts are fuzzy. 	Is the machine being used in very humid conditions?	Use in an environment that has suitable humidity.	1-3
Part of the image is periodically faint or shows white lines. 	—	Open and then close the rear cover.	—
	—	Run [Drum Refresh].	9-29
Copies have a moire pattern (dots grouped together in patterns and not aligned uniformly).	Is the original a printed photograph?	Set the image quality to [Photo].	3-45
Printouts are not clear.	Did you choose appropriate image quality for the original?	Select appropriate image quality.	3-45
	—	Run [Laser Scanner Cleaning].	9-29

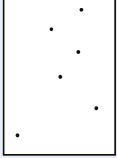
Symptom	Checkpoints	Corrective Actions	Reference Page
Printouts have black lines. 	Is the slit glass dirty?	Clean the slit glass.	10-6
	—	Run [Laser Scanner Cleaning].	9-29
Images are skewed.	Are the originals placed correctly?	When placing originals on the platen, align them with the original size indicator plates.	3-10
		When placing originals in the document processor, align the original width guides securely before placing the originals.	3-11
	Is the paper loaded correctly?	Check the position of the paper width guides.	3-2
When displaying an image sent from the machine on the PC, an image size is shrunk vertically or horizontally.	Have you selected 200 × 100dpi Normal or 200 × 400dpi Super for the scan resolution?	Select a scan resolution other than 200 × 100dpi Normal or 200 × 400dpi Super when sending an image.	3-44
Offset occurs. 	—	Run [Drum Refresh].	9-29
	—	Increase the adjustment value for [MC] setting. Increase the adjustment value 1 level at a time from the current value. If there is no improvement after the value is increased by 1 level, increase by 1 level again. If there is still no improvement, return the setting to the original value.	9-29
Part of the image is periodically faint or blurred. 	—	Decrease the adjustment value for [MC] setting. Decrease the adjustment value 1 level at a time from the current value. If there is no improvement after the value is decreased by 1 level, decrease by 1 level again. If there is still no improvement, return the setting to the original value.	9-29
Irregular horizontal lines appear in the image. 	—	Decrease the adjustment value for [MC] setting. Decrease the adjustment value 1 level at a time from the current value. If there is no improvement after the value is decreased by 1 level, decrease by 1 level again. If there is still no improvement, return the setting to the original value.	9-29
The altitude is 1500 m or higher and irregular horizontal white lines appear in the image. 	—	Set Altitude Adjustment to [High 1]. If there is still no improvement, change the value to [High 2].	9-29

Symptom	Checkpoints	Corrective Actions	Reference Page
<p>The altitude is 1500 m or higher and dots appear in the image.</p> 	—	Set Altitude Adjustment to [High 1]. If there is still no improvement, change the value to [High 2].	9-29
<p>Skewed-color printout.</p> 	—	Run [Calibration].	9-29
	—	Run [Color Registration].	9-30
<p>Colors appear different than you anticipated.</p>	Did you choose appropriate image quality for the original?	Select appropriate image quality.	3-45
	Have you loaded color copy paper into the paper tray?	Load color copy paper into the paper tray.	3-2
	—	Run [Calibration].	9-29
	—	When making copies Adjust the color balance.	4-14
	—	When printing from a computer Adjust the color using the printer driver.	<i>Printer Driver Operation Guide</i>

Symptom	Checkpoints	Corrective Actions	Reference Page
Cannot send via SMB.	Is the network cable connected?	Connect the correct network cable securely.	2-10
	Have the network settings for the equipment been configured properly?	Configure the TCP/IP settings properly.	9-19
	Have the folder sharing settings been configured properly?	Check sharing settings and access privileges under the folder properties.	6-7
	Has the SMB protocol been set to [On]?	Set the SMB protocol setting to [On].	2-32
	Has the [Host Name] been entered properly?*	Check the name of the computer to which data is being sent.	6-5
	Has the [Path] been entered properly?	Check the share name for the shared folder.	—
	Has the [Login User Name] been entered properly?*,**	Check the domain name and login user name.	6-18
	Has the same domain name been used for the [Host Name] and [Login User Name]?	Delete the domain name and backslash ("\") from the [Login User Name].	6-18
	Has the [Login Password] been entered properly?	Check the login password.	6-18
	Have exceptions for Windows Firewall been configured properly?	Configure exceptions for Windows Firewall properly.	6-10, 6-13
	Do the time settings for the equipment, domain server, and data destination computer differ?	Set the equipment, domain server, and data destination computer to the same time.	—
	Is the touch panel displaying <i>Send error</i> ?	Refer to <i>Responding to Send Error</i> .	10-19

* You can also enter a full computer name as the host name (for example, pc001.abcdnet.com).

** You can also enter login user names in the following formats:
 Domain_name/user_name (for example, abcdnet/james.smith)
 User_name@domain_name (for example, james.smith@abcdnet)

Responding to Error Messages

If the touch panel displays any of these messages, follow the corresponding procedure.

A

Error Message	Checkpoints	Corrective Actions	Reference Page
<i>Activation error.</i>	—	Failed to activate the application. Contact administrator.	—
	—	Expansion Authentication is disabled. Turn the main power switch off and on. If the error exists, contact administrator.	—
<i>Add the following paper in cassette #.</i>	Does the selected paper size matches the paper size loaded in the specified paper source?	Press [Continue] to continue printing. Press [Cancel] to cancel the job.	—
	Is the indicated cassette out of paper?	Load paper. Press [Paper Selection] to select the other paper source. Press [Continue] to print on the paper in the currently selected paper source.	3-3
<i>Add the following paper in the multi purpose tray.</i>	Does the selected paper size matches the paper size loaded in the specified paper source?	Press [Continue] to continue printing. Press [Cancel] to cancel the job.	—
	Is the paper of the selected size loaded in the multi purpose tray?	Load paper. Press [Paper Selection] to select the other paper source. Press [Continue] to print on the paper in the currently selected paper source.	3-6

B

Error Message	Checkpoints	Corrective Actions	Reference Page
<i>Box limit exceeded.*</i>	—	Document box is full, and no further storage is available; Job is canceled. Press [End]. Try to perform the job again after printing or deleting data from the Document box.	—

* When Auto Error Clear is set to [On], processing resumes automatically after a set amount of time elapses.

C

Error Message	Checkpoints	Corrective Actions	Reference Page
<i>Cannot connect to Authentication Server.*</i>	—	Set machine time to match the server's time.	9-27
	—	Check the domain name.	9-36
	—	Check the host name.	9-36
	—	Check the connection status with the server.	—
<i>Cannot duplex print on the following paper.*</i>	Did you select a paper size/type that cannot be duplex printed?	Press [Paper Selection] to select the available paper. Press [Continue] to print without using Duplex function.	4-7
<i>Cannot print the specified number of copies.*</i>	—	Only one copy is available due to processing too many jobs in parallel. Press [Continue] to continue printing. Press [Cancel] to cancel the job.	—
<i>Cannot process this job.*</i>	—	This job is canceled because it is restricted by User Authorization or Job Accounting. Press [End].	—
<i>Cassette is not installed.</i>	—	Cannot feed paper. Set the cassette indicated on the touch panel.	—
<i>Check the toner container.</i>	—	The toner container is not installed correctly. Set it correctly.	10-2
<i>Check waste toner box.</i>	Is the waste toner box full?	Replace the waste toner box.	10-4
	—	The waste toner box is not installed correctly. Set it correctly.	10-4

* When Auto Error Clear is set to [On], processing resumes automatically after a set amount of time elapses.

E

Error Message	Checkpoints	Corrective Actions	Reference Page
<i>Error occurred at cassette #.</i>	—	Remove the indicated cassette. Press [Next >] to follow the instructions.	—

F

Error Message	Checkpoints	Corrective Actions	Reference Page
<i>Failed to specify Job Accounting.*</i>	—	Failed to specify Job Accounting when processing the job externally. The job is canceled. Press [End].	—
<i>Failed to store job retention data.</i>	—	The job is canceled. Press [End].	—

* When Auto Error Clear is set to [On], processing resumes automatically after a set amount of time elapses.

H

Error Message	Checkpoints	Corrective Actions	Reference Page
<i>High temperature. Adjust room temp.</i>	—	Adjust the temperature and the humidity of your room.	1-3

I

Error Message	Checkpoints	Corrective Actions	Reference Page
<i>Incorrect account ID.*</i>	—	The account ID was incorrect when processing the job externally. The job is canceled. Press [End].	—
<i>Incorrect Login User Name or Password.*</i>	—	The login user name or password was incorrect when processing the job externally. The job is canceled. Press [End].	—
<i>Inner tray is full of paper.</i>	—	Remove paper from the inner tray. Press [Continue] to resume printing. Press [Cancel] to cancel the job.	—

* When Auto Error Clear is set to [On], processing resumes automatically after a set amount of time elapses.

J

Error Message	Checkpoints	Corrective Actions	Reference Page
<i>Job Accounting restriction exceeded.*</i>	Is the acceptable printing count restricted by Job Accounting exceeded?	The printing count exceeded the acceptable count restricted by Job Accounting. Cannot print any more. This job is canceled. Press [End].	—

* When Auto Error Clear is set to [On], processing resumes automatically after a set amount of time elapses.

K

Error Message	Checkpoints	Corrective Actions	Reference Page
<i>KPDL error.*</i>	—	PostScript error has occurred. The job is canceled. Press [End].	—

* When Auto Error Clear is set to [On], processing resumes automatically after a set amount of time elapses.

L

Error Message	Checkpoints	Corrective Actions	Reference Page
<i>Low temperature. Adjust room temp.</i>	—	Adjust the temperature and the humidity of your room.	1-3

M

Error Message	Checkpoints	Corrective Actions	Reference Page
<i>Machine failure.</i>	—	Internal error has occurred. Make a note of the error code displayed on the touch panel, and contact your Service Representative.	—
<i>Maximum number of scanned pages.</i>	Is the acceptable scanning count exceeded?	Only one copy of the scanned pages is available. Press [Continue] to print, send or store the scanned pages. Press [Cancel] to cancel printing, sending or storing.	—
<i>Memory is full.*</i>	—	Unable to continue the job as the memory is used up. Press [Continue] to print the scanned pages. The print job cannot be processed completely. Press [Cancel] to cancel the job.	—
	—	The process cannot be performed due to insufficient memory. If only [End] is available, press [End]. The job will be canceled.	—

* When Auto Error Clear is set to [On], processing resumes automatically after a set amount of time elapses.

P

Error Message	Checkpoints	Corrective Actions	Reference Page
<i>Paper jam.</i>	—	If a paper jam occurs, the machine will stop and the location of the jam will be indicated on the touch panel. Leave the machine on and follow the instruction to remove the jammed paper.	10-22
<i>Print overrun.</i>	—	Warning. Low printer memory. The job was paused. Re-starting the job. Press [Continue].	—

R

Error Message	Checkpoints	Corrective Actions	Reference Page
<i>RAM disk error.*</i>	—	<p>An error has occurred on the RAM disk. Job is canceled. Press [End].</p> <p>The possible error codes and their descriptions are as follows.</p> <p>01: The amount of data that can be saved at once has been exceeded. Restart the system or turn the power OFF/ON. If the error still occurs, divide the file into smaller files.</p> <p>04: Insufficient space on the RAM disk. Increase the RAM disk size by changing [RAM Disk Setting] in the system menu.</p> <p> NOTE: The range of RAM disk size can be increased by selecting [Printer Priority] in Optional Memory.</p>	9-26
<i>Removable memory error.*</i>	Is writing to a removable memory prohibited?	<p>An error occurred in the removable memory. The job stopped. Press [End].</p> <p>Possible error codes are as follows:</p> <p>01: Connect a removable memory that can be written to.</p>	7-17
	—	<p>An error occurred in the removable memory. The job stopped. Press [End].</p> <p>Possible error codes are as follows:</p> <p>01: The amount of data that can be saved at once has been exceeded. Restart the system or turn the power OFF/ON. If the error still occurs, the removable memory is not compatible with the machine. Use the removable memory formatted by this machine. If the removable memory cannot be formatted, it is damaged. Connect a compatible removable memory.</p>	7-17
<i>Removable Memory is full.*</i>	—	<p>Job is canceled. Press [End].</p> <p>Insufficient free space in the removable memory. Delete unneeded files.</p>	—
<i>Remove originals in the document processor.</i>	Are there any originals left in the document processor?	Remove originals from the document processor.	—
<i>Replace all originals and press [Continue].</i>	—	<p>Remove originals from the document processor, put them back in their original order, and place them again. Press [Continue] to resume printing.</p> <p>Press [Cancel] to cancel the job.</p>	—
<i>Replace MK.</i>	—	Replacement of the parts in the maintenance kit is necessary at every 200,000 pages of printing and requires professional servicing. Contact your Service Representative.	—

* When Auto Error Clear is set to [On], processing resumes automatically after a set amount of time elapses.

S

Error Message	Checkpoints	Corrective Actions	Reference Page
<i>Scanner memory is full.*</i>	—	Scanning cannot be performed due to insufficient memory of scanner. Only one copy of the scanned pages is available. Press [Continue] to print, send or store the scanned pages. Press [Cancel] to cancel the printing job.	—
<i>Send error.*</i>	—	An error has occurred during transmission. Refer to <i>Responding to Send Error</i> for the error code and corrective actions.	10-19
<i>System error.</i>	—	System error has occurred. Follow the instructions on the touch panel.	—

* When Auto Error Clear is set to [On], processing resumes automatically after a set amount of time elapses.

T

Error Message	Checkpoints	Corrective Actions	Reference Page
<i>The cover is open.</i>	Is there any cover which is open?	Close the cover indicated on the touch panel.	—
<i>The phone receiver is off the hook.</i>	—	Put down the receiver.	—
<i>The power cable is unplugged.</i>	—	Disconnect the power cord from the machine and connect it to the paper feeder (multi purpose).	—
<i>This memory is not formatted.</i>	Is the removable memory formatted by this machine?	Perform [Format] on this machine.	8-14
<i>Toner is empty. [C][M][Y][K]</i>	—	Replace the toner container.	10-2
<i>Toner is running out. [C][M][Y][K]</i>	—	It is almost time to replace the toner container. Obtain a new toner container.	—





U

Error Message	Checkpoints	Corrective Actions	Reference Page
<i>Unknown Toner Installed.</i>	Is the installed toner container our own brand?	We will not be liable for any damage caused by the use of third party supplies in this machine.	—
<i>Unknown Toner Installed. PC [C][M][Y][K]</i>	Does the installed toner container's regional specification match the machine's?	Install the specified container.	—

W

Error Message	Checkpoints	Corrective Actions	Reference Page
<i>Warning low memory.</i>	—	Job cannot be started. Try again later.	—

Responding to Send Error

Code	Error	Corrective Actions	Reference Page
1101	<i>Failed to send the e-mail.</i>	Check the host name of the SMTP server on the Command Center RX.	2-34
	<i>Failed to send via FTP.</i>	Check the host name of FTP.	6-20
	<i>Failed to send via SMB.</i>	Check the host name of SMB.	6-20
1102	<i>Failed to send via SMB.</i>	Check the SMB settings. <ul style="list-style-type: none"> • Login user name and login password  NOTE: If the sender is a domain user, specify the domain name. <ul style="list-style-type: none"> • Host name • Path 	6-20
	<i>Failed to send the e-mail.</i>	Check the followings on the Command Center RX. <ul style="list-style-type: none"> • SMTP login user name and login password • POP3 login user name and login password 	2-34
	<i>Failed to send via FTP.</i>	Check the FTP settings. <ul style="list-style-type: none"> • Login user name and login password  NOTE: If the sender is a domain user, specify the domain name. <ul style="list-style-type: none"> • Path • Folder share permissions of the recipient 	6-20
1103	<i>Failed to send via SMB.</i>	Check the SMB settings. <ul style="list-style-type: none"> • Login user name and login password  NOTE: If the sender is a domain user, specify the domain name. <ul style="list-style-type: none"> • Path • Folder share permissions of the recipient 	6-20
	<i>Failed to send via FTP.</i>	Check the FTP settings. <ul style="list-style-type: none"> • Path • Folder share permissions of the recipient 	6-20
1104	<i>Failed to send the e-mail.</i>	Check the e-mail address.  NOTE: If the address is rejected by the domain, you cannot send the e-mail.	6-17
1105	<i>Failed to send via SMB.</i>	Select [On] of the SMB settings on the Command Center RX.	2-32
	<i>Failed to send the e-mail.</i>	Select [On] of the SMTP settings on the Command Center RX.	
	<i>Failed to send via FTP.</i>	Select [On] of the FTP settings on the Command Center RX.	
1106	<i>Failed to send the e-mail.</i>	Check the sender address of SMTP on the Command Center RX.	2-34
1131	<i>Failed to send via FTP.</i>	Select [On] of the secure protocol settings on the Command Center RX.	2-32

Code	Error	Corrective Actions	Reference Page
1132	<i>Failed to send via FTP.</i>	Check the followings of the FTP server. <ul style="list-style-type: none"> • Is FTPS available? • Is the encryption available? 	2-32
2101	<i>Failed to send via SMB. Failed to send via FTP.</i>	Check the network and SMB settings. Check the network and FTP settings. <ul style="list-style-type: none"> • The network cable is connected. • The hub is not operating properly. • The server is not operating properly. • Host name and IP address • Port number 	2-32
	<i>Failed to send the e-mail.</i>	Check the network and Command Center RX. <ul style="list-style-type: none"> • The network cable is connected. • The hub is not operating properly. • POP3 server name of the POP3 user • SMTP server name 	
2102 2103	<i>Failed to send via FTP.</i>	Check the followings of the FTP server. <ul style="list-style-type: none"> • Is FTP available? • The server is not operating properly. 	—
	<i>Failed to send the e-mail.</i>	Check the network. <ul style="list-style-type: none"> • The network cable is connected. • The hub is not operating properly. • The server is not operating properly. 	
2201	<i>Failed to send the e-mail. Failed to send via FTP. Failed to send via SMB.</i>	Check the network. <ul style="list-style-type: none"> • The network cable is connected. • The hub is not operating properly. • The server is not operating properly. 	—
2202	<i>Failed to send the e-mail. Failed to send via FTP.</i>		
2203	<i>Failed to send via FTP. Failed to send via SMB.</i>		
2204	<i>Failed to send the e-mail.</i>	Check the e-mail size limit of the SMTP settings on the Command Center RX.	2-34
2231	<i>Failed to send via FTP.</i>	Check the network. <ul style="list-style-type: none"> • The network cable is connected. • The hub is not operating properly. • The server is not operating properly. 	—
3101	<i>Failed to send the e-mail.</i>	Check the authentication methods of both the sender and the recipient.	—
	<i>Failed to send via FTP.</i>	Check the network. <ul style="list-style-type: none"> • The network cable is connected. • The hub is not operating properly. • The server is not operating properly. 	
3201	<i>Failed to send the e-mail.</i>	Check the SMTP user authentication method of the recipient.	—

Code	Error	Corrective Actions	Reference Page
0007 4201 4701 5101 5102 5103 5104 7101 7102 7103 720f	—	Turn the main power switch off and back on. If this error occurs several times, make a note of the displayed error code and contact your service representative.	2-13

Clearing Paper Jams

If a paper jam occurs, the touch panel will display *Paper jam.* and the machine will stop. Refer to these procedures to remove the jammed paper.

How to read the screen



[< Back]	Returns to the previous step.
[Next >]	Advances to the next step.
[Hold]	Puts the current step on hold, and switches to the Status screen. The status of jobs can be checked. (Refer to <i>Checking Job Status on page 8-2.</i>)

Paper Jam Location

Detailed paper jam positions are as follows. Refer to the indicated page number to remove the paper jam.

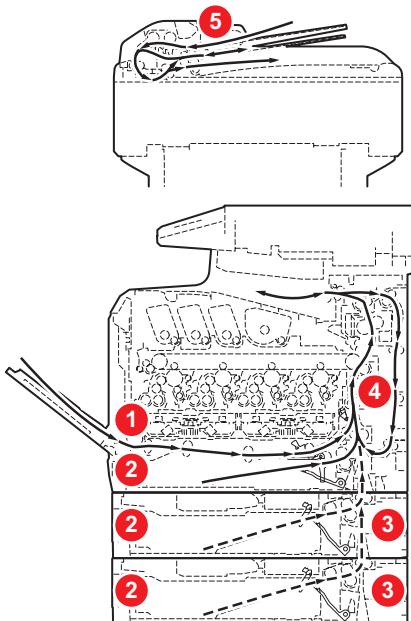

Paper Jam Location	Description	Reference Page
1	Clear the paper jammed in the multi purpose tray.	10-23
2	Clear the paper jammed in cassette.	10-23
3	Clear the paper jammed in paper feeder.	10-24
4	Clear the paper jammed inside the machine.	10-24
5	Clear the paper jammed in the document processor.	10-26

Precautions with Paper Jams

- Do not reuse jammed papers.
- If the paper tears during removal, be sure to remove any loose scraps of paper from inside the machine.
- Scraps of paper left in the machine could cause subsequent jamming.

CAUTION

The fixing unit is extremely hot. Take sufficient care when working in this area, as there is a danger of getting burned.

Multi Purpose Tray

Follow the steps below to clear paper jams in the multi purpose tray.

1

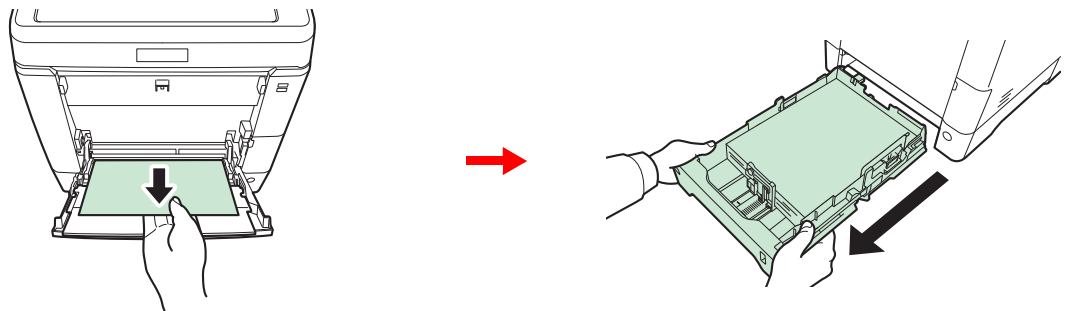

2

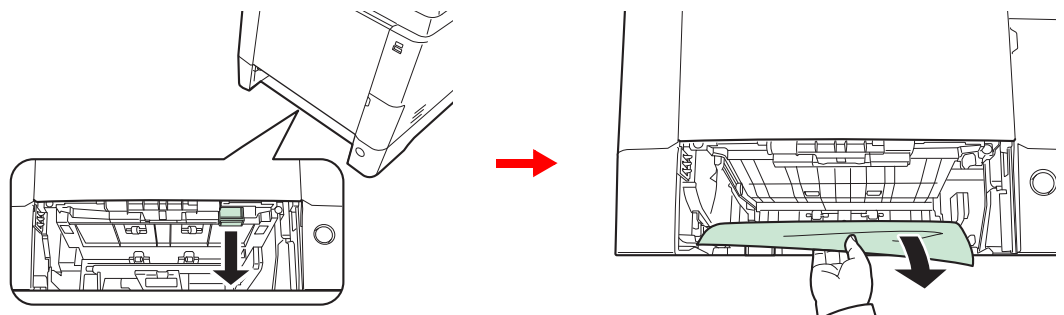

Cassette

Follow the steps below to clear paper jams in cassette.

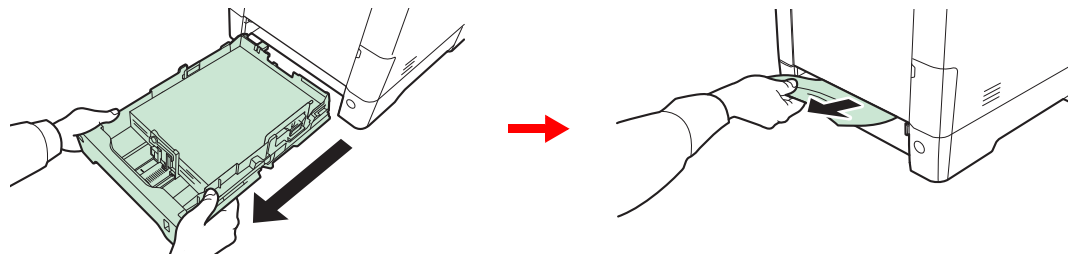

NOTE

If the paper cannot be removed, do not try to forcefully remove it. Go to paper jam *Inside the Machine* on page 10-24.

Paper Feeder

Follow the steps below to clear paper jams in the optional paper feeder.

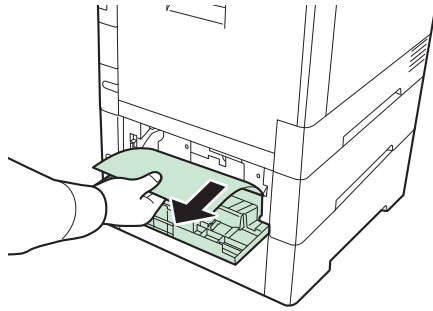

NOTE

If the paper cannot be removed, do not try to forcefully remove it. Go to paper jam *Inside the Machine* on page 10-24.

Inside the Machine

Follow the steps below to clear paper jams inside the machine.

1

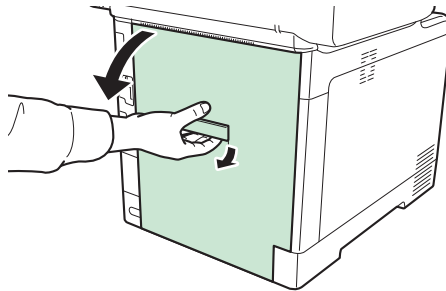

CAUTION

Some parts are very hot inside the machine. Exercise caution as there is a risk of burn injury.

2

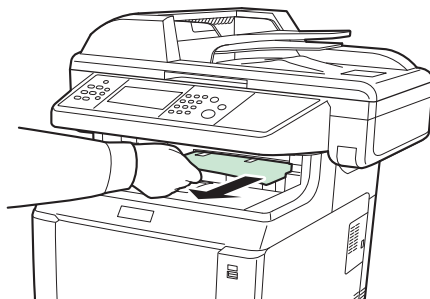

If most of the jammed paper is out in the inner tray, grasp the paper and pull it out.

3

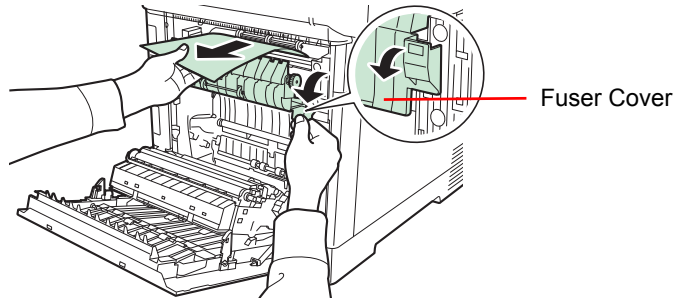

If the jammed paper reaches the fuser unit as shown, open the fuser cover, grasp the paper, and pull it out.

4

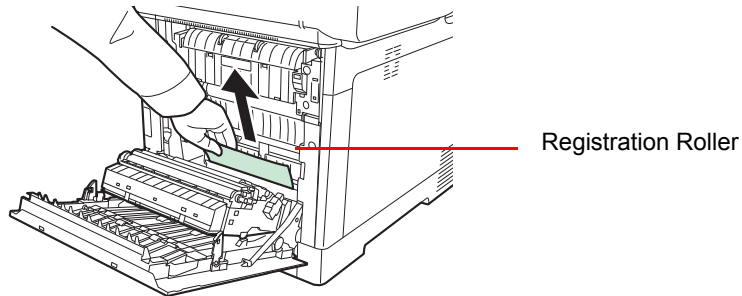

If the jammed paper does not reach the registration roller (metal) as shown, grasp the paper and pull it out.

5

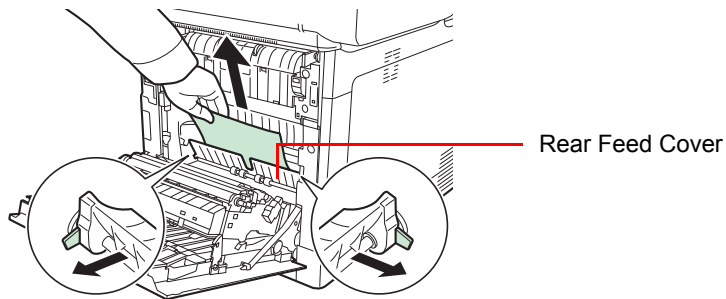

If the jammed paper is located inside the machine as shown, open the rear feed cover and pull out the paper.

6

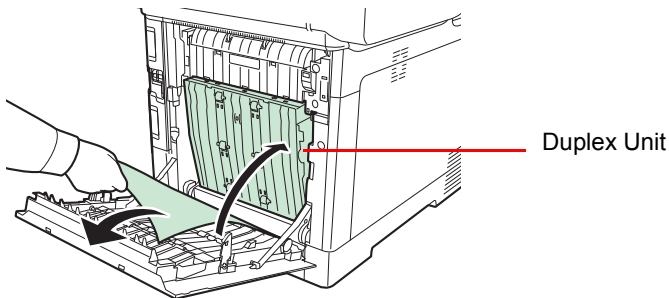

If the jammed paper reaches the Duplex Unit as shown, lift up the Duplex Unit and remove the paper.

Document Processor

Follow the steps below to clear paper jams in the document processor.

1

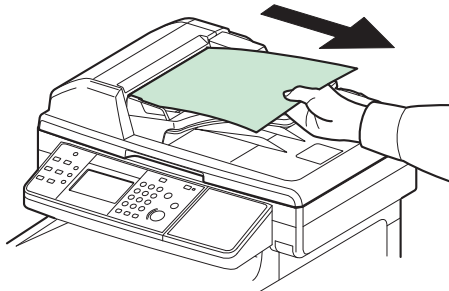

2

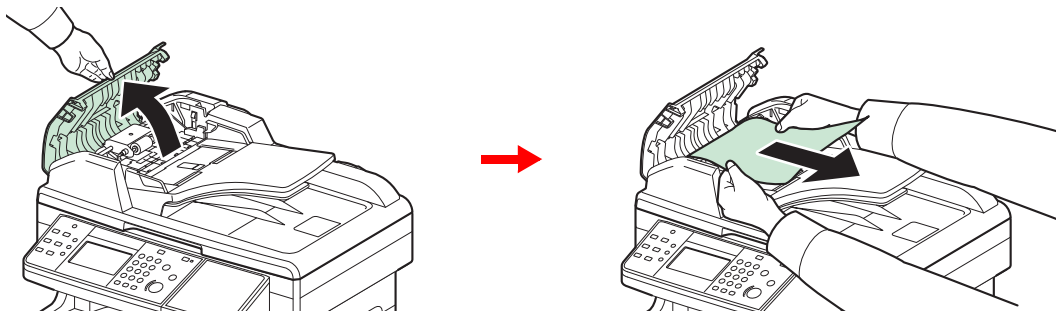

If the original is caught in the rollers or difficult to remove, proceed to the next step.

3

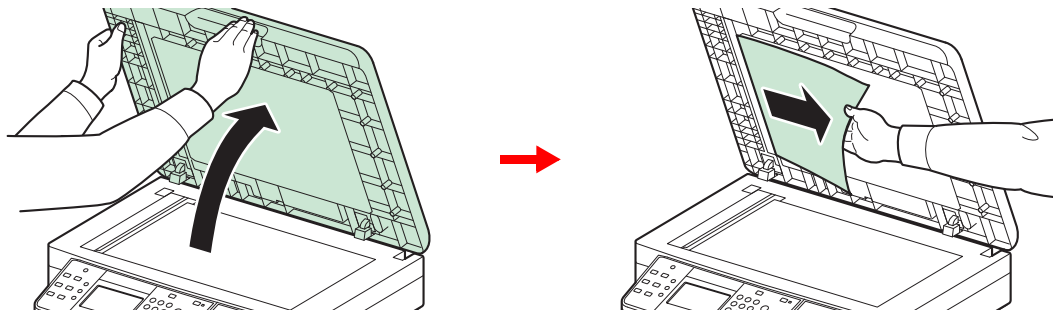

11 Appendix

This chapter explains the following topics:

Optional Equipment	11-2
Overview of Optional Equipment	11-2
Paper Feeder	11-2
Expansion Memory	11-3
Card Authentication Kit	11-4
SSD	11-4
Network Interface Kit	11-5
Wireless Network Interface Kit	11-5
USB Keyboard	11-5
ThinPrint Option	11-5
Optional Function	11-6
Character Entry Method	11-8
Entry Screens	11-8
Entering Characters	11-10
Paper	11-11
Basic Paper Specifications	11-12
Choosing the Appropriate Paper	11-12
Special Paper	11-15
Specifications	11-19
Common Functions	11-19
Copy Functions	11-20
Printer Functions	11-21
Scanner	11-21
Document Processor	11-22
Environmental Specifications	11-22
Glossary	11-23

Optional Equipment

Overview of Optional Equipment

The following optional equipment is available for the machine.

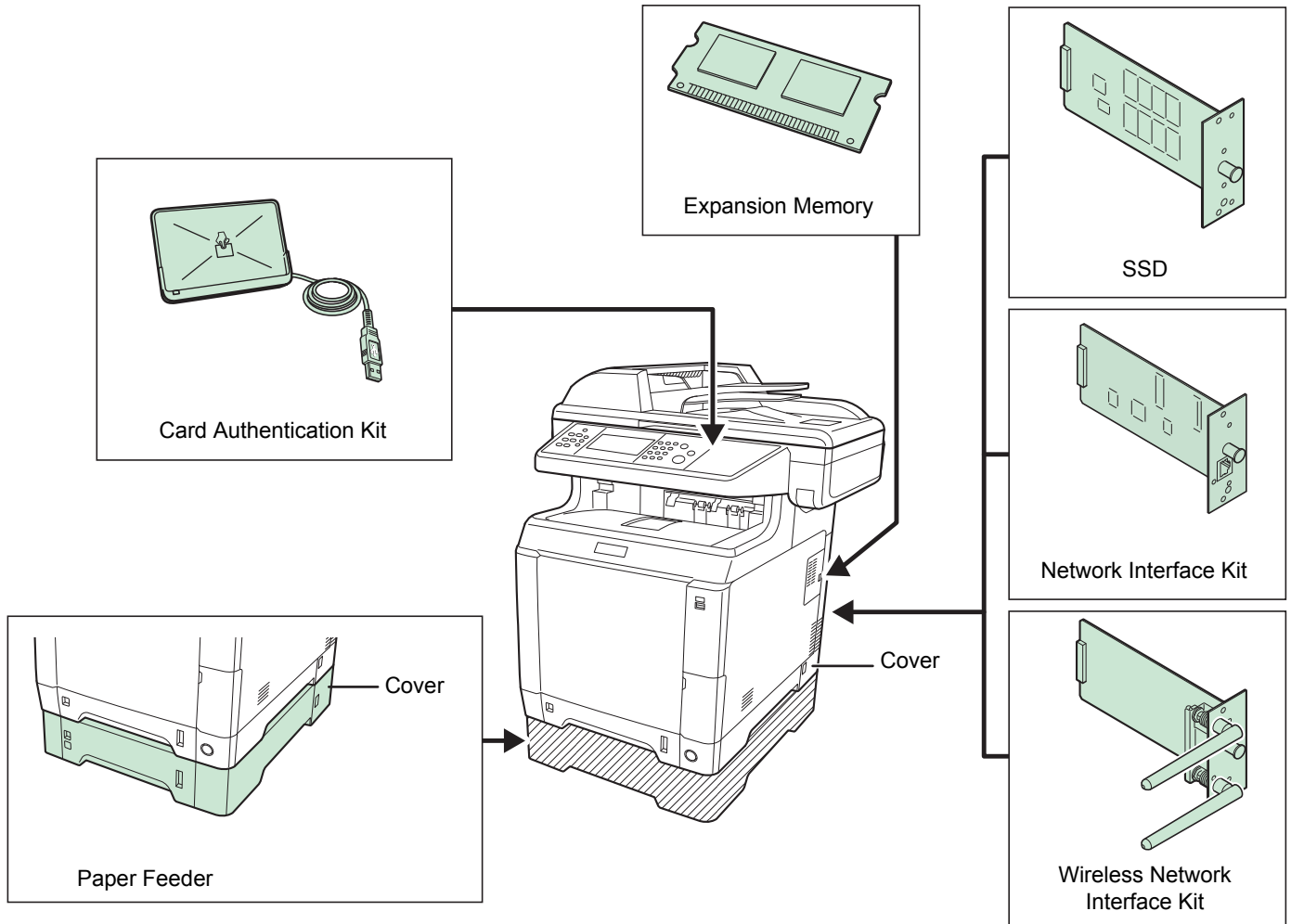

Paper Feeder

The optional paper feeder (for plain paper) and paper feeder (multi purpose) (for multiuse media) will each hold approximately 500 sheets of paper (80 g/m²). Up to 2 optional feeders can be installed in the machine. Loading method is the same as Cassettes 1.

NOTE
To allow paper to be removed when a paper jam occurs, there is a cover (rear cover) on the rear side of the paper feeder.

IMPORTANT
When using the paper feeder, be sure to replace the cover.

Expansion Memory

To expand the printer memory for more complex print jobs and faster print speed, you can plug in optional memory module (dual in line memory module) in the memory slot provided on the main controller board. You can select additional memory module from 256, 512 or 1024 MB. The maximum memory size is 2048MB.

Precautions for Handling the Memory Module

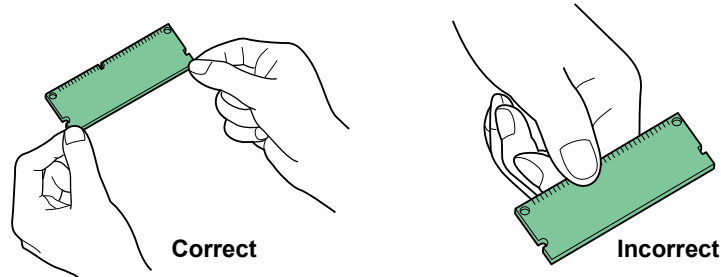

To protect electronic parts, discharge static electricity from your body by touching a water pipe (faucet) or other large metal object before handling the memory module. Or, wear an antistatic wrist strap, if possible, when you install the memory module.

Installing the Memory Module

1 Power off.

Turn off the machine and disconnect the power cord and interface cable.

2 Remove the covers.

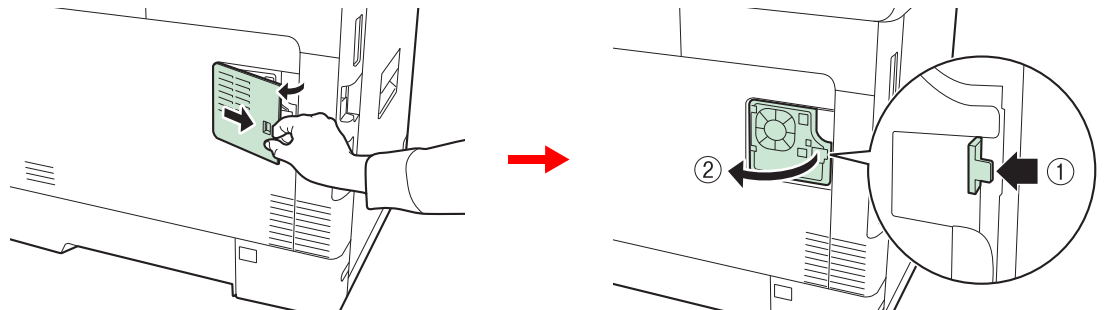

3 Install the memory module.

1 Remove the memory module from its package.

- 2 With the memory connection terminal pointing toward the socket, align the cut-out part with the socket terminal and insert directly in at an angle.

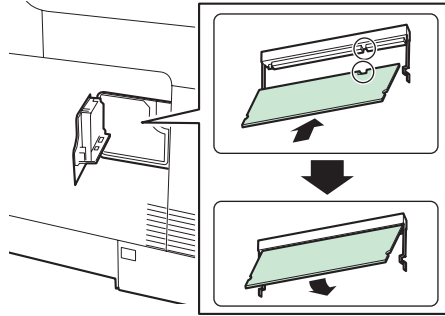

✔ IMPORTANT

Before inserting a memory module in the machine, make sure that the machine is switched off.

- 3 Carefully press the inserted memory down and into the machine.
- 4 Reinstall the covers.

Removing the Memory Module

To remove a memory module, remove the right cover and the memory slot cover from the machine. Then, carefully push out the two socket clamps. Ease the memory module out of the socket to remove.

Verifying the Expanded Memory

To verify that the memory module is working properly, test it by printing a status page.



Refer to *Report* on page 9-5.

Card Authentication Kit

User login administration can be performed using IC cards. To do so, it is necessary to register IC card information on the previously registered local user list. For more information about how to register this information, refer to the *IC Card Authentication Kit Operation Guide*.

SSD

With SSD installed in the machine, received data can be rasterized and stored on this SSD. This enables high-speed printing of multiple copies using an electric sort function. Also, you can use the Document Box functions. For details, refer to *Document Box* on page 7-1.

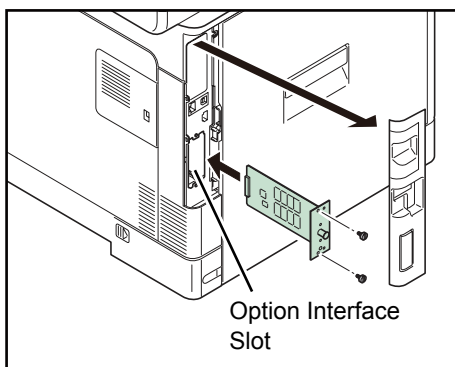

Network Interface Kit

The Network Interface Kit provides a high-speed connection for the Gigabit-per-second interface. Since the kit was designed to work with TCP/IP and NetBEUI protocols, in the same way as the main unit, it fulfills the network printing demands on Windows, Macintosh, and UNIX environments. This expansion kit is also compatible with ThinPrint.

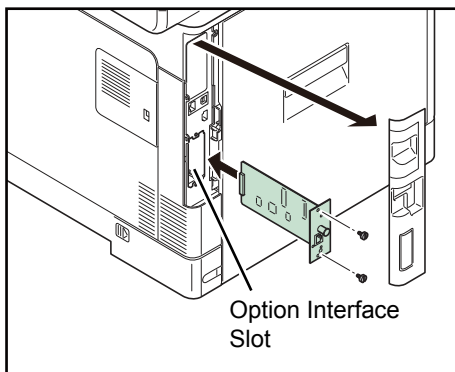

Wireless Network Interface Kit

This is a wireless network interface kit which supports the wireless network specifications IEEE802.11n (Max 300 Mbps) and 11 g/b. With the utilities supplied, settings are possible for a variety of OS and network protocols..

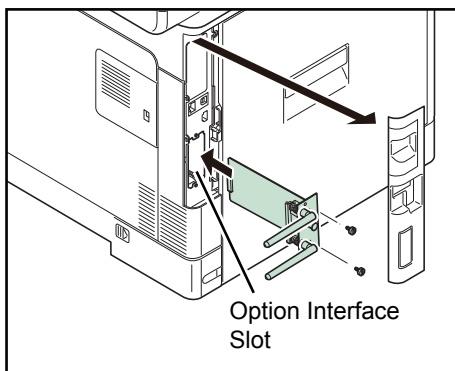

USB Keyboard

A USB keyboard can be used to enter information into the text fields on the operation panel. Please contact your dealer or service representative for information on keyboards that are compatible with your MFP before you purchase one.

ThinPrint Option

This application allows print data to be printed directly without a print driver.

Optional Function

You can use the optional applications installed on this machine.

Overview of the Applications

The applications listed below are installed on this machine. You can use these applications for a limited period on a trial basis.

UG-33 (ThinPrint) (This application can only be activated in Europe.)

This application allows print data to be printed directly without a print driver.

NOTE
Restrictions such as the number of times the application can be used during the trial period differ depending on the application.

Starting Application Use

Use the procedure below to start using an application.

NOTE
If user login administration is disabled, the user authentication screen appears. Enter your login user name and password and then press [Login]. For this, you need to login with administrator privileges. Refer to *Adding a User on page 9-40* for the default login user name and password.

1 Display the screen.

◆ System Menu / Counter



1

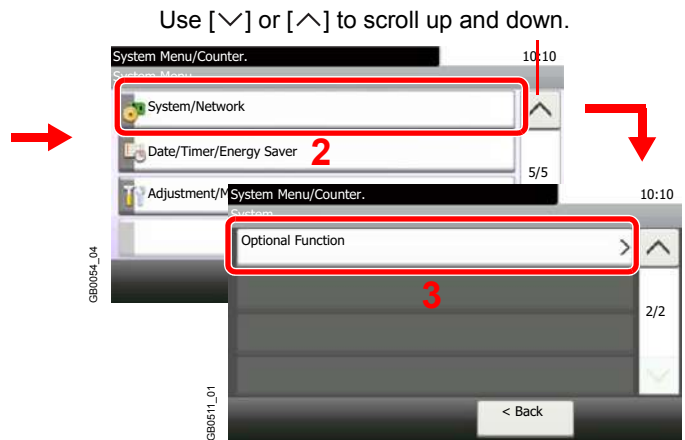

2 Start using an application.

1 Select the desired application and press [Activate].



Displays details for individual applications.

2 Select [Official] and enter the license key using the numeric keys.

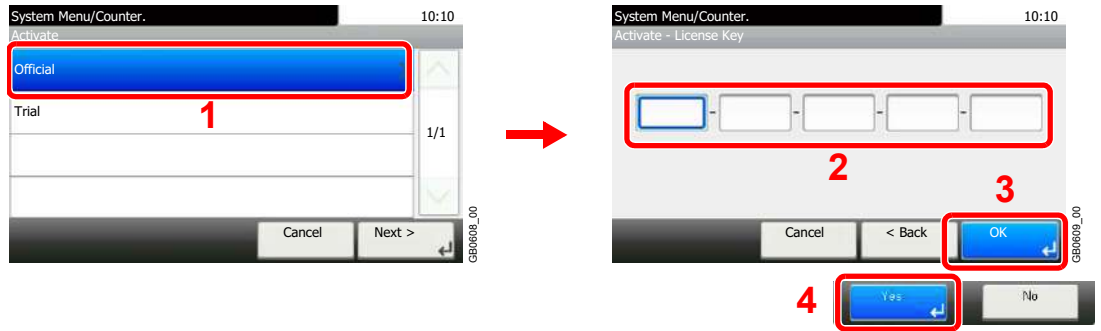

Some applications do not require you to enter a license key.

To use the application as a trial, select [Trial].



IMPORTANT

If you change the date/time while using an application, you will no longer be able to use the application

Character Entry Method

To enter characters for a name, use the on-display keyboard in the touch panel following the steps as explained below.

NOTE
 QWERTY, QWERTZ and AZERTY are available as keyboard layouts the same as a PC keyboard. Press the **System Menu/Counter** key, [Common Settings] and then [Keyboard Layout] to choose desired layout. QWERTY layout is used here as an example. You may use another layout following the same steps.

Entry Screens

Lower-case Letter Entry Screen

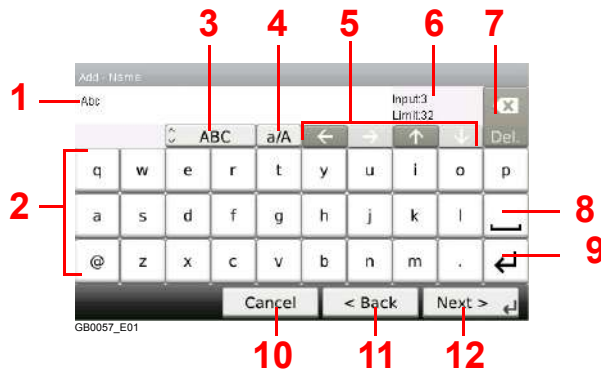

No.	Display/Key	Description
1	Display	Displays entered characters.
2	Keyboard	Press the character to enter.
3	[ABC] / [Symbol]	Select the characters that are entered. To enter symbols or numbers, select [Symbol].
4	[A/a] / [a/A]	Press to switch between upper case and lower case.
5	Cursor Key	Press to move the cursor on the display.
6	[Input] / [Limit] Display	Displays maximum number of characters and the number of characters entered.
7	Delete Key	Press to delete a character to the left of the cursor.
8	Space Key	Press to insert a space.
9	Enter Key	Press to enter a line break.
10	[Cancel]	Press to cancel entered characters and return to the screen before the entry was made.
11	[< Back]	Press to return to the previous screen.
12	[OK] / [Next >]	Press to save the entered characters and move to the next screen.

Upper-case Letter Entry Screen



Number/Symbol Entry Screen

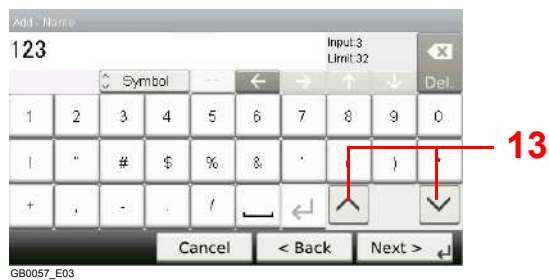

No.	Display/Key	Description
13	[▲]/[▼]	To enter a number or symbol not shown in the keyboard, press the cursor key and scroll the screen to view other numbers or symbols to enter.

Entering Characters

Follow the steps below to enter 'List A-1' for an example.

1 Enter 'List', (space).

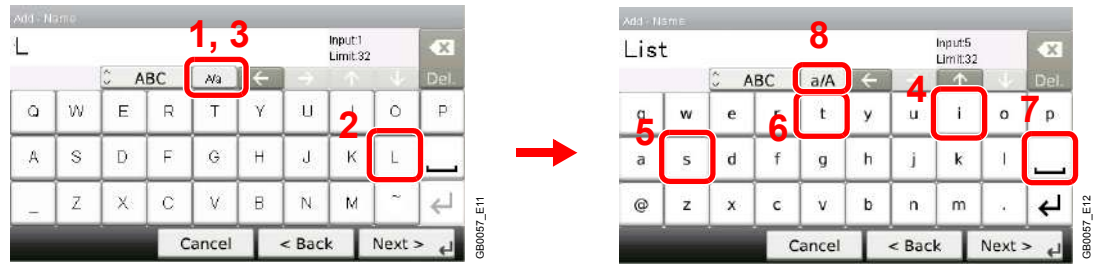

To shift from lower case to upper case letters, press [a/A]. To shift from upper case to lower case letters, press [A/a].

2 Enter 'A-1'.

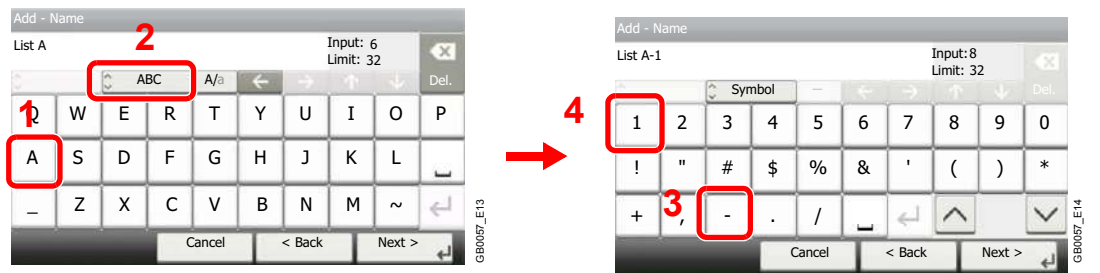

To enter numbers or symbols, press [ABC] to display [Symbol].

3 Register the characters you entered.

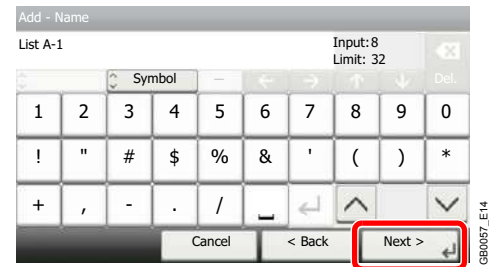

Press [Next>]. The entered characters are registered.

Paper

This section explains the paper sizes and types that can be used in the paper source.

Cassettes

Supported types	Supported paper sizes	No. of sheets
Plain (60 g/m ² to 163 g/m ²) Recycled (60 g/m ² to 163 g/m ²)	A4, B5, A5, Folio, Legal, Letter, Oficio II, Statement, Executive, A6, Envelope C5, 16K, 216 × 340 mm, Custom	250 (80 g/m ²)

Optional paper feeder

Supported types	Supported paper sizes	No. of sheets
Plain (60 g/m ² to 163 g/m ²) Recycled (60 g/m ² to 163 g/m ²) Color (60 g/m ² to 163 g/m ²)	Letter, Legal, Statement, Executive, Oficio II, A4, A5, B5, Folio, 16K, 216 × 340 mm, ISO B5, Envelope #6, Envelope C5, Youkei 2, Envelope #10, Envelope DL, Envelope #9, Envelope Monarch, Youkei 4, Oufuku Hagaki, Custom	500 (80 g/m ²)

Optional paper feeder (multi purpose)

Supported types	Supported paper sizes	No. of sheets
Plain (60 g/m ² to 220 g/m ²) Recycled (60 g/m ² to 220 g/m ²) Color (60 g/m ² to 220 g/m ²)	Letter, Legal, Statement, Executive, Oficio II, A4, A5, B5, Folio, 16K, 216 × 340 mm, Custom	500 (80 g/m ²)
Envelopes	ISO B5, Envelope #6, Envelope C5, Youkei 2, Envelope #10, Envelope DL, Envelope #9, Envelope Monarch, Youkei 4, Oufuku Hagaki	Loading height: 40 mm

Multi Purpose tray

Supported types	Supported paper sizes	No. of sheets
Plain, Preprinted, Labels, Bond, Recycled, Rough, Vellum, Letterhead, Color, Prepunched, Coated, High Quality, Custom 1 to 8	Letter, Legal, Statement, Executive, Oficio II, A4, A5, A6, B5, B6, Folio, 16K, 216 × 340 mm Other sizes: Portrait-2.76 to 8.50" or 70 to 216 mm Landscape-5.83 to 14.02" or 148 to 356 mm	50 (80 g/m ²)
Thick paper	A4, JIS B5, A5, Folio, Legal, Letter, Oficio II, Statement, Executive, A6, B6, ISO B5, 16K Other sizes: Portrait-2.76 to 8.50" or 70 to 216 mm Landscape-5.83 to 14.02" or 148 to 356 mm	1
Postcards Oufuku Hagaki (return postcard)	Postcards (100 × 148 mm) Return postcard (148 × 200 mm)	15
Envelopes	ISO B5, Envelope #10, Envelope #9, Envelope #6, Envelope Monarch, Envelope DL, Envelope C5, Youkei 4, Youkei 2 Other sizes: Portrait-2.76 to 8.50" or 70 to 216 mm Landscape-5.83 to 14.02" or 148 to 356 mm	5
Transparency (OHP film)	Letter, A4	1

Basic Paper Specifications

This machine is designed to print on standard copy paper as used in regular ('dry') copiers and page printers such as laser printers. It also supports a variety of other types of paper that conform to the specifications given in this appendix.

Be careful when choosing paper. Paper unsuitable for the machine may cause jams or may be wrinkled.

Supported Paper

Use standard copy paper for regular copiers or laser printers. The printing quality will be affected by the quality of paper. Poor quality paper may result in unsatisfactory output.

Basic Paper Specifications

The following table lists the specifications of paper that is supported with this machine. Refer to the subsequent sections for further details.

Criteria	Specifications
Weight	Cassettes: 60 to 163 g/m ²
	Multi purpose tray: 60 to 220 g/m ²
Thickness	0.086 to 0.230 mm
Dimensional accuracy	±0.7 mm
Squareness of corners	90°±0.2°
Moisture content	4 to 6%
Grain direction	Long grain (paper supply direction)
Pulp content	80% or more



NOTE

Some recycled paper does not meet requirements for use with this machine as listed in the Basic Paper Specifications shown below, such as moisture or pulp content. For this reason, we recommend purchasing a small amount of recycled paper as a sample for testing prior to use. Choose recycled paper that gives the best printing results and contains low levels of paper dust.

We are not responsible for the problems occurred from the use of paper that does not conform to our specifications.

Choosing the Appropriate Paper

This section describes guidelines for choosing paper.

Condition

Avoid using paper with bent corners or that is curled, dirty, or torn. Do not use paper that has a rough surface or paper fiber lint, or that is especially delicate. Use of paper in any of these conditions will not only deliver poor copies but may also cause jams and shorten the useful life of the machine. Choose paper with a smooth and even surface; however, avoid coated paper or paper with a treated surface as it may damage the drum or fusing unit.

Ingredient

Do not use paper such as paper that has been coated or surface-treated or paper that contains plastic or carbon. These paper may produce harmful fumes from the heat of printing and may damage the drum.

Be sure to use the standard paper that contains at least 80% pulp, i.e., not more than 20% of the total paper content consists of cotton or other fibers.

Supported Paper Sizes

Paper of the following sizes is supported by the machine.

Measurements in the table take into account a ± 0.7 mm dimensional accuracy for length and width. Corner angles must be $90^\circ \pm 0.2^\circ$.

Multi Purpose Tray	Cassette or Multi Purpose Tray
B6 (186 × 128 mm)	A4 (297 × 210 mm)
Envelope #10 (Commercial #10) (4-1/8 × 9-1/2")*	A5 (210 × 148 mm)
Envelope #9 (Commercial #9) (3-7/8 × 8-7/8")*	A6 (148 × 105 mm)**
Envelope #6 (Commercial #6 3/4) (3-5/8 × 6-1/2")*	B5 (257 × 182 mm)
Envelope Monarch (3-7/8 × 7-1/2")*	Folio (210 × 330 mm)
Envelope DL (110 × 220 mm)*	Letter
Hagaki (100 × 148mm)	Legal
Oufukuhagaki (148 × 200 mm)*	Statement
Youkei 4 (105 × 235 mm)*	Executive (7-1/4 × 10-1/2")
Youkei 2 (114 × 162 mm)*	Oficio II
	16K (273 × 197 mm)
	ISO B5 (176 × 250 mm)
	Envelope C5 (162 × 229 mm)
	216 × 340 mm
	Size Entry (70 × 148 to 216 × 352 mm)

* These paper sizes can be loaded into the optional paper feeder.

** Except for the optional paper feeder.

Smoothness

The paper surface should be smooth, but it must be uncoated. With paper that is too smooth and slippery, several sheets may accidentally be supplied at once, causing jams.

Basis Weight

In countries that use the metric system, basis weight is the weight in grams of one sheet of paper one square meter in area. In the United States, basis weight is the weight in pounds of one ream (500 sheets) of paper cut to the standard size (or trade size) for a specific grade of paper. Paper that is too heavy or too light may be supplied incorrectly or cause paper jams, which may cause excessive wear of the machine. Mixed paper weight (i.e., thickness) may cause several sheets to be supplied at once accidentally and may also cause blurring or other printing problems if the toner fails to adhere correctly.

Thickness

Avoid using paper that is too thick or thin. Signs that paper may be thin include frequent problems with paper jams or with several sheets being supplied at once. Paper jams may also indicate that the paper is too thick. The proper thickness is between 0.086 and 0.110 mm.

Moisture Content

Paper moisture content is the ratio of moisture to dryness expressed as a percentage. Moisture affects how the paper is supplied, the electrostatic changeability of the paper, and how the toner adheres.

Paper moisture content varies depending on the relative humidity in the room. High relative humidity causes paper to become damp, making the edges expand so it appears wavy. Low relative humidity causes paper to lose moisture, making the edges tighten and weakening print contrast.

Wavy or tight edges may cause the paper to slip when it is supplied. Try to keep the moisture content between 4 to 6%.

To maintain the right level of moisture content, bear in mind the following considerations.

- Store paper in a cool, well-ventilated place.
- Store paper flat and unopened in the package. Once the package is opened, reseal it if the paper is not to be used for a while.
- Store paper sealed in the original package and box. Put a pallet under the carton to keep it raised above the floor. Especially during rainy seasons keep the paper a sufficient distance away from wooden or concrete floors.
- Before using paper that has been stored, keep it at the proper moisture level for at least 48 hours.
- Do not store paper where it is exposed to heat, sunlight, or dampness.

Other Paper Specifications

Porosity: The density of the paper fibers

Stiffness: Paper must be stiff enough or it may buckle in the machine, causing jams.

Curl: Most paper naturally tends to curl after the package is opened. When paper passes through the fixing unit, it curls upward slightly. To deliver flat printouts, load the paper so that the curl faces towards the bottom of the paper tray.

Static electricity: During printing, paper is electrostatically charged so that the toner adheres. Choose paper that can be discharged quickly so that copies do not cling together.

Whiteness: Paper whiteness affects print contrast. Use whiter paper for sharper, brighter copies.

Quality: Machine problems may occur if sheet sizes are not uniform or if corners are not square, edges are rough, sheets are uncut, or edges or corners are crushed. In order to prevent these problems, be especially careful when you cut the paper yourself.

Packaging: Choose paper that is properly packaged and stacked in boxes. Ideally, the packaging itself should have been treated with a coating to inhibit moisture.

Specially treated paper: We do not recommend printing onto the following types of paper, even if it conforms to the basic specifications. When you use these kinds of paper, purchase a small amount first as a sample to test.

- Glossy paper
- Watermarked paper
- Paper with an uneven surface
- Perforated paper

Special Paper

This section describes printing onto special paper and print media.

The following paper and media can be used.

- Transparencies
- Preprinted paper
- Bond paper
- Recycled paper
- Thin paper (from 60 g/m² to 64 g/m² or less)
- Letterhead
- Colored paper
- Prepunched paper
- Envelopes
- Cardstocks (Hagaki)
- Thick paper (from 106 g/m² to 220 g/m² or less)
- Labels
- Coated paper
- High-quality paper

When using these paper and media, choose that are designed specifically for copiers or page printers (such as laser printers). Use the multi purpose tray for transparencies, thick paper, envelopes, cardstocks, and labels.

Choosing Special Paper

Although special paper that meets the following requirements can be used with the machine, print quality will vary considerably due to differences in the construction and quality of special paper. Thus, special paper is more likely than regular paper to cause printing problems. Before purchasing special paper in volume, try testing a sample to ensure the print quality is satisfactory. General precautions when printing onto special paper are given below. Note that we are not responsible for any harm to the user or damage to the machine caused by moisture or specifications of special paper.

Select a cassette or multi purpose tray for special paper.

Transparencies

Transparencies must be able to withstand the heat of printing. Transparencies must meet the following conditions.

Heat resistance	Must withstand at least 190°C
Thickness	0.100 to 0.110 mm
Material	Polyester
Dimensional accuracy	±0.7 mm
Squareness of corners	90° ±0.2°

To avoid problems, use the multi purpose tray for transparencies and load transparencies with the long side facing the machine.

If transparencies jam frequently at output, try pulling the leading edge of sheets gently as they are ejected.

Label

Be sure to feed labels from the multi purpose tray or paper feeder (multi purpose).

For selecting labels, use extreme care so that the adhesive may not come in direct contact with any part of the machine and that the labels are not easily peeled from the carrier sheet. Adhesives that stick to the drum or rollers and peeled labels remaining in the machine may cause a failure.

When printing onto labels, you must be liable for the print quality and possible trouble.

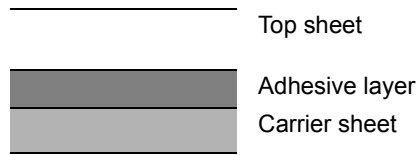

Labels consist of three layers as shown in the illustration. The adhesive layer contains materials that are easily affected by the force applied in the machine. The carrier sheet bears the top sheet until the label is used. This composition of labels may cause more problems.

The label surface must be covered completely with the top sheet. Gaps between labels may cause peeling of labels, resulting in a serious failure.

Some label paper has large margins on the top sheet. When using such paper, do not peel these margins from the carrier sheet before completing output.

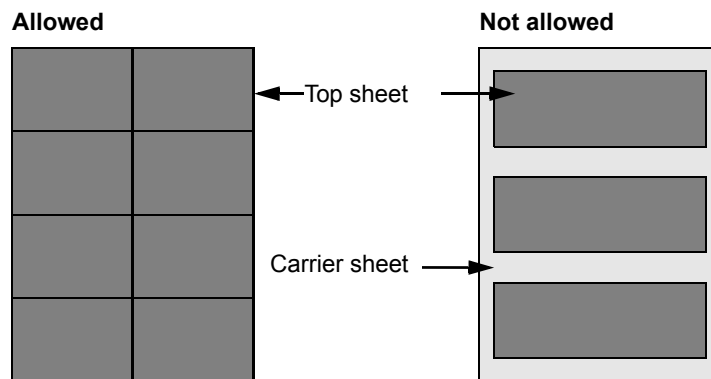

Use label paper that conforms to the following specifications.

Top sheet weight	44 to 74 g/m ²
Basis weight (overall paper weight)	104 to 151 g/m ²
Top sheet thickness	0.086 to 0.107 mm
Overall paper thickness	0.115 to 0.160 mm
Moisture content	4 to 6 % (composite)

Hagaki

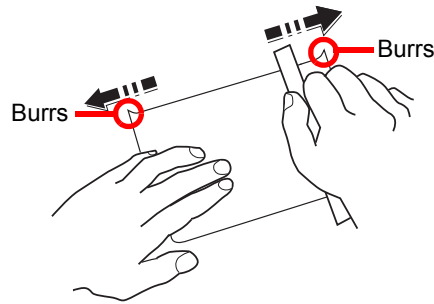

Before loading Hagaki into the multi purpose tray, fan them and align the edges. If the Hagaki paper is curled, straighten it before loading. Printing onto curled Hagaki may cause jams.

Use unfolded Oufukuhagaki (available at post offices). Some Hagaki may still have rough edges developed by a paper cutter on the back side. Remove any such rough edges by placing the Hagaki on a flat surface and rubbing the edges gently a few times with a ruler.

Envelopes

Envelopes should always be fed from the multi purpose tray or paper feeder (multi purpose), with the print-side up. If you use envelopes quite often, we recommend to use the paper feeder (multi purpose).

Due to the structure of envelopes, printing evenly over the entire surface may not be possible in some cases. Thin envelopes in particular may be wrinkled by the machine in some cases as they pass through. Before purchasing envelopes in volume, try testing a sample to ensure the print quality.

Storing envelopes for a long period may cause them to become wrinkled. Thus, keep the package sealed until you are ready to use them.

Keep the following points in mind.

- Do not use envelopes with exposed adhesive. In addition, do not use the type of envelope in which the adhesive is exposed after the top layer is peeled off. Serious damage may be caused if the paper covering the adhesive comes off in the machine.
- Do not use envelopes with certain special features. For example, do not use envelopes with a grommet for winding a string to close the flap or envelopes with an open or film-covered window.
- If paper jams occur, load fewer envelopes at once.

Thick Paper

Before loading thick paper in the multi purpose tray, fan it and align the edges. Some thick paper may still have rough edges developed by a paper cutter on the back side. Remove any such rough edges just as with Hagaki by placing the paper on a flat surface and rubbing the edges gently a few times with a ruler. Printing onto paper with rough edges may cause jams



NOTE

If the paper is not supplied correctly even after it is smoothed, load the paper in the multi purpose tray with the leading edge raised a few millimeters.

Colored Paper

Colored paper must conform to the specifications listed on the page 11-12. In addition, the pigments in the paper must be able to withstand the heat of printing (up to 200°C or 392°F).

Preprinted Paper

Preprinted paper must conform to the specifications listed on the page 11-12. The colored ink must be able to withstand the heat of printing. It must be resistant to silicone oil as well. Do not use paper with a treated surface such as glossy paper used for calendars.

Recycled Paper

Recycled paper must conform to the specifications listed on the page 11-12; however, its whiteness may be considered separately.



NOTE

Before purchasing recycled paper in volume, try testing a sample to ensure that the print quality.

Coated Paper

Coated paper is created by treating the surface of the base paper with a coating that provides higher printing quality than plain paper. Coated paper is used for particularly high quality printing.

The surface of high-quality or medium-quality paper is coated with special agents that improve ink adhesion by making the paper surface smoother. These agents are used either to coat both sides of the paper or just one side. The coated side appears slightly glossy.



IMPORTANT

When printing on coated paper in very humid environments, ensure that the paper is kept dry as moisture may cause sheets to stick together when they are fed into the machine. If printing in very humid environments, set coated paper for one sheet each.

Paper Type Indicators

If you are going to load non-standard paper in the paper feeder (multi purpose), fold the provided paper type indicator sheet into thirds so that the appropriate paper type symbol faces out and is at the top, and insert it into the cassette's display folder.

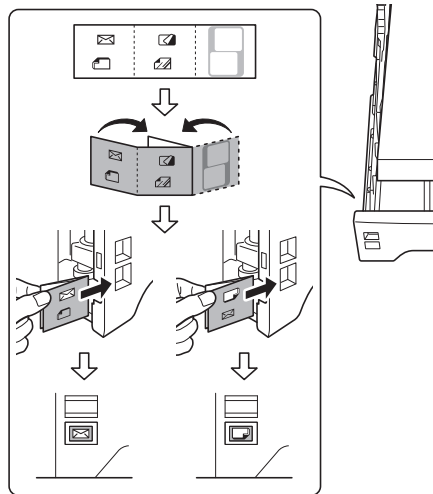

 :Envelopes

 :Thick paper

 :Labels

 :Coated paper



The blank sheet can be used to write in any name or symbol. When writing in a name or symbol on the bottom part of the sheet, invert it with respect to the top part.

Specifications



IMPORTANT

Specifications are subject to change without notice.

Common Functions

Item		Description	
		ECOSYS M6026cidn	ECOSYS M6526cidn
Type		Desktop	
Printing Method		Electrophotography by semiconductor laser	
Image Write System		Semiconductor laser	
Paper Weight	Cassette	60 to 163 g/m ² (Duplex: 60 to 163 g/m ²)	
	Multi Purpose Tray	60 to 220 g/m ² , 230 μm (Cardstock)	
Media Type	Cassette	Plain, Rough, Recycled, Preprinted, Bond, Color, Prepunched, Letterhead, Thick, High Quality, Custom 1 to 8 (Duplex: Same as Simplex)	
	Multi Purpose Tray	Plain, Transparency (OHP film), Rough, Vellum, Labels, Recycled, Preprinted, Bond, Cardstock, Color, Prepunched, Letterhead, Thick, Envelope, Coated, High Quality, Custom 1 to 8	
Paper Size	Cassette	Maximum: 8-1/2 × 14"/Legal (Duplex: 8-1/2 × 14"/Legal) Minimum: 5-1/2 × 8-1/2"/A6 (Duplex: 7-1/4 × 10-1/2"/A5)	
	Multi Purpose Tray	Maximum: 8-1/2 × 14"/Legal Minimum: 3-5/8 × 6-1/2"/A6	
Paper Capacity	Cassette	250 sheets (80 g/m ²)	
	Multi Purpose Tray	50 sheets (80 g/m ² , plain paper)	
Output Tray Capacity		150 sheets (80 g/m ²)	
Main Memory	Standard	1024 MB	
	Maximum	2048 MB	
Interface	Standard	USB Hi-Speed Interface: 1 (Print, Scan (WIA)) USB memory slot: 2 (Print from USB, Scan to USB, Card Authentication Kit) Network interface (10 BASE-T/100 BASE-TX/1000 BASE-T (TCP/IP, NetBEUI)): 1 (Print, Scan (TWAIN/WIA), Send to Folder (SMB/FTP), Send as E-mail)	
	Option	eKUIO slot: 1	
Operating Environment	Temperature	10 to 32.5°C/50 to 90.5°F	
	Humidity	15 to 80 %	
	Altitude	8,200 feet/2,500 m or less	
	Brightness	1,500 lux or less	
Warm-up Time (22°C/71.6°F, 60%)	Power on	29 seconds or less	
	Low Power Mode	11 seconds or less	
	Sleep	20 seconds or less	

Item	Description	
	ECOSYS M6026cidn	ECOSYS M6526cidn
Dimension (W × D × H)	20-15/64 × 21-42/64 × 23-3/4" 514 × 550 × 603 mm	
Weight (with toner container)	84.92 lb/38.6 kg	85.14 lb/38.7 kg
Space Required (W × D)	20-15/64 × 29-1/2" 514 × 750 mm (with Multi Purpose Tray expanded)	
Power Source	120V Specification Model: 120V AC, 60Hz more than 9.0A 230V Specification Model: 220 - 240V AC, 50/60Hz more than 4.8A	
Options	Paper feeder (up to 2 units), Expansion memory, Card Authentication Kit, SSD, Network Interface Kit, Wireless Network Interface Kit	

Copy Functions

Item		Description
Max. Copy Speed		A4: 26 sheets/min Letter: 28 sheets/min A5/B5/A6 (until 15th image): 28 sheets/min A5/B5/A6 (from 16th image): 14 sheets/min Legal: 23 sheets/min
First Print Time (A4, feed from Cassette)	When using the document processor	Color: 13 seconds or less, Black & White: 11 seconds or less
	When the document processor is not used	Color: 12 seconds or less, Black & White: 10 seconds or less
Zoom Level		Manual mode: 25 to 400%, 1% increments Fixed magnifications: 400%, 200%, 141%, 129%, 115%, 90%, 86%, 78%, 70%, 64%, 50%, 25%
Continuous Copying		1 to 999 sheets (can be set in one sheet increments)
Resolution		600 × 600 dpi
Supported Original Types		Sheet, Book, 3-dimensional objects (maximum original size: Folio/Legal)
Original Feed System		Fixed

Printer Functions

Item		Description	
Printing Speed (60 to 105 g/m ²)	Simplex	A4: 26 sheets/min Letter: 28 sheets/min Legal: 23 sheets/min	A5/B5/A6 (until 15th image): 28 sheets/min A5/B5/A6 (from 16th image): 14 sheets/min
	Duplex	A4: 13 sheets/min Legal: 12 sheets/min	Letter: 13 sheets/min
First Print Time (A4, feed from Cassette)		Black & White: 9.0 seconds or less Color: 10.5 seconds or less	
Resolution		600 dpi	
Operating System		Windows XP, Windows Server 2003, Windows Vista, Windows 7, Windows Server 2008, Windows Server 2012, Windows 8, Apple Macintosh OS X (10.5 or later)	
Page Description Language		PRESCRIBE	
Emulations		PCL6 (PCL5c, PCL-XL), KPDL3 (PostScript 3 compatible), PDF Direct Print Ver.1.7, XPS	

Scanner

Item		Description	
Resolution		600 dpi, 400 dpi, 300 dpi, 200 dpi, 200 × 400 dpi, 200 × 100 dpi (Resolution in FAX mode included)	
File Format		TIFF, JPEG, PDF, XPS, PDF/A, High Comp. PDF	
Scanning Speed		1-sided: B/W 35 Images/min Color 25 Images/min 2-sided: B/W 18 Images/min Color 13 Images/min (A4 landscape, 300 dpi, Image quality: Text/Photo original)	
Network Protocol		TCP/IP	
Transmission System		PC transmission	SMB: Scan to SMB
			FTP: Scan to FTP, FTP over SSL
		E-mail transmission	SMTP: Scan to E-mail
		TWAIN scan*	
		WIA scan**	

* Available Operating System: Windows XP, Windows Server 2003, Windows Vista, Windows 7, Windows Server 2008, Windows Server 2008 R2, Windows Server 2012, Windows 8

** Available Operating System: Windows Vista, Windows 7, Windows Server 2008, Windows Server 2008 R2, Windows Server 2012, Windows 8

Document Processor

Item	Description
Original Feed Method	Automatic feed
Supported Original Types	Sheet originals
Paper Size	Maximum: Legal/A4 Minimum: Statement/A5
Paper Weight	50 to 120 g/m ² (Duplex: 50 to 110 g/m ²)
Loading Capacity	50 sheets (50 to 80 g/m ²) maximum
Dimensions (W) × (D) × (H)	19-19/64 × 21 × 4-3/32" 490 × 338 × 104 mm
Weight	3 kg or less

Environmental Specifications

Item	Description
Time to Low Power mode (default setting)	1 minute
Recovery time from Low Power mode	11 seconds or less
Time to Sleep mode (default setting)	15 minutes
Recovery time from Sleep mode	20 seconds or less
Duplexing	Standard
Paper supply capability	100% recycled paper may be used.



NOTE

Consult your dealer or service representative for recommended paper types.

EN ISO 7779

Der höchste Schalldruckpegel beträgt 70 dB (A) oder weniger gemäß EN ISO 7779.

EK1-ITB 2000

Das Gerät ist nicht für die Benutzung im unmittelbaren Gesichtsfeld am Bildschirmarbeitsplatz vorgesehen. Um störende Reflexionen am Bildschirmarbeitsplatz zu vermeiden, darf dieses Produkt nicht im unmittelbaren Gesichtsfeld platziert werden.

Glossary

Auto Form Feed Timeout

During data transmission, the machine may sometimes have to wait until receiving the next data. This is the auto form feed timeout. When the preset timeout passes, the machine automatically put paper out. However, no output is performed if the last page has no data to be printed.

Auto-IP

Auto-IP is a module that enables dynamic IPv4 addresses to be assigned to a device on startup. However, DHCP requires a DHCP server. Auto-IP is a server-less method of choosing an IP address. IP addresses between 169.254.0.0 to 169.254.255.255 are reserved for Auto-IP and assigned automatically.

Auto Paper Selection

A function to automatically select paper in the same size as original at printing

Auto Sleep

A mode designed for electrical power saving, activated when the machine is left unused or data transfer for a specific period. In Sleep mode, power consumption is kept to a minimum.

Bonjour

Bonjour, also known as zero-configuration networking, is a service that automatically detects computers, devices and services on an IP network. Bonjour, because an industry-standard IP protocol is used, allows devices to automatically recognize each other without an IP address being specified or DNS server being set. Bonjour also sends and receives network packets by UDP port 5353. If a firewall is enabled, the user must check that UDP port 5353 is left open so that Bonjour will run correctly. Some firewalls are set up so as to reject only certain Bonjour packets. If Bonjour does not run stably, check the firewall settings and ensure that Bonjour is registered on the exceptions list and that Bonjour packets are accepted. If you install Bonjour on Windows XP Service Pack 2 or later, the Windows firewall will be set up correctly for Bonjour.

Default Gateway

This indicates the device, such as a computer or router, that serves as the entrance/exit (gateway) for accessing computers outside the network that you are on, When no specific gateway is designated for a destination IP address, data is sent to the host designated as the Default Gateway.

DHCP (Dynamic Host Configuration Protocol)

Dynamic Host Configuration Protocol (DHCP) that automatically resolves IP addresses, subnet masks, and gateway addresses on a TCP/IP network. DHCP minimizes the load of network management employing a large number of client computers because it relieves individual clients including printers from the IP address being assigned.

DHCP (IPv6)

DHCP (IPv6) is the next-generation of the Internet's Dynamic Host Configuration Protocol and supports IPv6. It extends the BOOTP startup protocol that defines the protocols used for transferring configuration information to hosts on the network. DHCP (IPv6) permits the DHCP server to use its expanded functionality to send configuration parameters to an IPv6 node. Because the network addresses that can be used are allocated automatically, the IPv6 node management workload is reduced in systems where the administrator has to exercise close control over IP address allocation.

dpi (dots per inch)

A unit for resolution, representing the number of dots printed per inch (25.4 mm).

EcoPrint Mode

A printing mode that helps save toner. Copies made in this mode are thus lighter than normal.

Enhanced WSD

Kyocera's proprietary web services.

Emulation

The function to interpret and execute other printers' page description languages. The machine emulates operation of PCL6 and KPDL3 (PostScript 3 compatible).

FTP (File Transfer Protocol)

A protocol to transfer files on the TCP/IP network, whether the Internet or an intranet. Along with HTTP and SMTP/POP, FTP is now frequently used on the Internet.

Grayscale

A computer color expression. Displayed images of this sort are typically composed of shades of gray, varying from black at the weakest intensity to white at the strongest, without any other colors. Gray levels are displayed in numerical levels: that is, white and black only for 1 bit; 256 gray levels (including white and black) for 8 bits; and 65,536 gray levels for 16 bits.

Help

A ? (Help) key is provided on this machine's operation panel. If you are unsure of how to operate the machine, would like more information on its functions or are having problems getting the machine to work properly, press the ? (Help) key to view a detailed explanation on the touch panel.

IP Address

An Internet protocol address is a unique number that represents a specific computer or related device on the network. The format of an IP address is four sets of numbers separated by dots, e.g. 192.168.110.171. Each number should be between 0 and 255.

IPP

IPP (Internet Printing Protocol) is a standard that uses TCP/IP networks such as the Internet to enable print jobs to be sent between remote computers and printers. IPP is an extension of the HTTP protocol used to view websites and enables printing to be carried out via routers on printers in remote locations. It also supports the HTTP authentication mechanisms along with SSL server and client authentication as well as encryption.

KPDL (Kyocera Page Description Language)

Kyocera's PostScript page description language compatible with Adobe PostScript Level 3.

Multi Purpose (MP) Tray

The paper supply tray on the right side of the machine. Use this tray instead of the cassettes when printing onto envelopes, Hagaki, transparencies, or labels.

NetBEUI (NetBIOS Extended User Interface)

An interface, developed by IBM in 1985, as an update from NetBIOS. It enables more advanced functions on smaller networks than other protocols such as TCP/IP, etc. It is not suitable for larger networks due to lack of routing capabilities to choose the most appropriate routes. NetBEUI has been adopted by IBM for its OS/2 and Microsoft for its Windows as a standard protocol for file sharing and printing services.

PDF/A

This is "ISO 19005-1. Document management - Electronic document file format for long-term preservation - Part 1: Use of PDF (PDF/A)", and is a file format based on PDF 1.4. It has been standardized as ISO 19005-1, and is a specialization of PDF, which has been mainly used for printing, for long-term storage. A new part, ISO 19005-2 (PDF/A-2), is currently being prepared.

POP3 (Post Office Protocol 3)

A standard protocol to receive E-mail from the server in which the mail is stored on the Internet or an intranet.

PostScript

A page description language developed by Adobe Systems. It enables flexible font functions and highly-functional graphics, allowing higher quality printing. The first version called Level 1 was launched in 1985, followed by Level 2 that enabled color printing and two-byte languages (e.g. Japanese) in 1990. In 1996, Level 3 was released as an update for the Internet access and PDF format as well as gradual improvements in implementation technologies.

PPM (prints per minute)

This indicates the number of A4 size printouts made in one minute.

Printer Driver

The software to enable you to print data created on any application software. The printer driver for the machine is contained in the DVD enclosed in the package. Install the printer driver on the computer connected to the machine.

RA (Stateless)

The IPv6 router communicates (transmits) information such as the global address prefix using ICMPv6. This information is the Router Advertisement (RA). ICMPv6 stands for Internet Control Message Protocol, and is a IPv6 standard defined in the RFC 2463 "Internet Control Message Protocol (ICMPv6) for the Internet Protocol Version 6 (IPv6) Specification".

Send as E-mail

A function to send the image data stored in the machine as an E-mail attachment. E-mail addresses can be selected from the list or entered at each time.

SMTP (Simple Mail Transfer Protocol)

A protocol for E-mail transmission over the Internet or an intranet. It is used for transferring mail between mail servers as well as for sending mail from clients to their servers.

Status Page

The page lists machine conditions, such as the memory capacity, total number of prints and scans, and paper source settings.

Subnet Mask

The subnet mask is a way of augmenting the network address section of an IP address. A subnet mask represents all network address sections as 1 and all host address sections as 0. The number of bits in the prefix indicates the length of the network address. The term "prefix" refers to something added to the beginning and, in this context, indicates the first section of the IP address. When an IP address is written, the length of the network address is indicated by the prefix length after a forward slash (/). For example, "24" in the address "133.210.2.0/24". In this way, "133.210.2.0/24" denotes the IP address "133.210.2.0" with a 24-bit prefix (network section). This new network address section (originally part of the host address) made possible by the subnet mask is referred to as the subnet address. When you enter the subnet mask, be sure to set the *DHCP* setting to *Off*.

TCP/IP (Transmission Control Protocol/Internet Protocol)

TCP/IP is a suite of protocols designed to define the way computers and other devices communicate with each other over a network.

TCP/IP (IPv6)

TCP/IP (IPv6) is based on the current Internet protocol, TCP/IP (IPv4). IPv6 is the next-generation Internet protocol and expands the available address space, which resolves the problem of the lack of addresses under IPv4, while also introducing other improvements such as additional security functionality and the capacity to prioritize data transmission.

TWAIN (Technology Without Any Interested Name)

A technical specification for connecting scanners, digital cameras, and other image equipment to the computers. The TWAIN compatible devices enable you to process image data on any relevant application software. TWAIN is adopted on a large amount of graphic software (e.g. Adobe Photoshop) and OCR software.

USB (Universal Serial Bus)2.0

A USB interface standard for Hi-Speed USB 2.0. The maximum transfer rate is 480 Mbps. This machine is equipped with USB 2.0 for high-speed data transfer.

WIA (Windows Imaging Acquisition)

A function to import images supported after Windows Me/XP from digital cameras and other peripheral devices. This function replaces what TWAIN used to do; the feature is provided as a part of Windows functions and improves ease of operation, so that you import images directly to My Computer without using any application.

Index

A

- Address Book
 - Adding a Contact [6-24](#)
 - Adding a Group [6-28](#)
 - Editing and Deleting [6-31](#)
- Adjustment/Maintenance
 - Auto Color Correction [9-28](#)
 - Background Density Adj. [9-28](#)
 - Calibration [9-29](#)
 - Color Registration [9-28](#)
 - Correcting Black Line [9-28](#)
 - Density Adjustment [9-28](#)
 - Display Brightness [9-28](#)
 - Drum Refresh [9-29](#)
 - Laser Scanner Cleaning [9-29](#)
- Application [9-16](#)
- Auto Form Feed Timeout [11-23](#)
- Auto-IP [11-23](#)
 - Setup [9-19](#)
- Automatic 2-Sided Copy Function [1-12](#)
- Auto Paper Selection [11-23](#)
- Auto Sleep [2-28](#), [11-23](#)

B

- Background Density Adjust [3-48](#)
- Bonjour [11-23](#)
 - Setup [9-20](#)

C

- Card Authentication Kit [11-4](#)
- Cassette
 - Loading Paper [3-3](#)
 - Paper Size and Media Type [3-29](#), [9-7](#)
- Cassette 1 [2-2](#)
- Character Entry Method [11-8](#)
- Checking the Counter [3-14](#)
- Cleaning
 - Document Processor [10-6](#)
 - Glass Platen [10-6](#)
 - Paper Transfer Unit [10-7](#)
- Coated Paper [11-18](#)
- Collate [3-42](#)
- Color Balance [4-14](#)
- Colored Paper [11-17](#)
- Color Registration [9-28](#)
- Color Selection [3-53](#)
- Combine [4-10](#)
 - 2 in 1 [4-10](#)
 - 4 in 1 [4-10](#)
 - Border Line [4-10](#)
- Command Center RX [2-30](#)
- Connecting
 - LAN Cable [2-10](#)
 - Power Cable [2-11](#)
 - USB Cable [2-11](#)
- Connection Method [2-8](#)

- Continuous Scan [3-39](#)
- Conventions in This Guide [1-13](#)
- Copying [4-1](#)
- Copying Settings
 - Auto % Priority [9-14](#)
 - Auto Paper Selection [9-14](#)
 - DP Read Action [9-14](#)
 - Reserve Next Priority [9-14](#)
- Copy Speed [11-20](#)
- Custom Box
 - Creating a New Box [7-3](#)

D

- Date/Time [2-29](#)
- Date/Timer/Energy Saver [9-27](#)
 - Auto Error Clear [9-27](#)
 - Auto Panel Reset [9-27](#)
 - Date/Time [9-27](#)
 - Date Format [9-27](#)
 - Low Power Timer [9-27](#)
 - Panel Reset Timer [9-27](#)
 - Sleep Level [9-27](#)
 - Sleep Rules [9-27](#)
 - Sleep Timer [9-27](#)
 - Time Zone [9-27](#)
 - Unusable Time [9-28](#)
- Default
 - Background Density Adj. (Copy) [9-12](#)
 - Background Density Adj. (Send/Store) [9-12](#)
 - Collate [9-11](#)
 - Color Selection (Copy) [9-11](#)
 - Color Selection (Send/Store) [9-12](#)
 - Continuous Scan (Except FAX) [9-12](#)
 - EcoPrint [9-12](#)
 - E-mail Subject/Body [9-12](#)
 - File Format [9-11](#)
 - File Name Entry [9-12](#)
 - File Separation [9-11](#)
 - FTP Encrypted TX [9-12](#)
 - Image Quality [9-13](#)
 - JPEG/TIFF Print [9-12](#)
 - Original Image(Copy) [9-12](#)
 - Original Image(Send/Store) [9-12](#)
 - Original Orientation [9-11](#)
 - PDF/A Setting [9-13](#)
 - Scan Resolution [9-11](#)
 - XPS Fit to Page [9-12](#)
 - Zoom [9-12](#)
- Default Gateway [11-23](#)
 - Setup [9-19](#)
- Default Screen [9-9](#)
- Density [3-43](#)

- Destination [6-14](#)
 - Checking and Editing [6-22](#)
 - Choosing by One Touch Key [6-16](#)
 - Choosing from the Address Book [6-14](#)
 - Dest. Check before Send [9-15](#)
 - Entering a New E-mail Address [6-17](#)
 - Entry Check for New Dest. [9-15](#)
 - Multi Sending [6-23](#)
 - Specifying a New PC Folder [6-18](#)
 - Device Status [8-13](#)
 - Connection Status [8-14](#)
 - FAX [8-14](#)
 - Printer [8-14](#)
 - Removable Memory [8-14](#)
 - Scanner [8-13](#)
 - SSD [8-15](#)
 - DHCP [11-23](#)
 - Setup [9-19](#)
 - DHCP (IPv6) [11-23](#)
 - Setup [9-20](#)
 - Display Status/Log [9-14](#)
 - Document Box
 - Job Box [7-2](#)
 - Document Processor [2-2](#)
 - Document Processor Cover [2-5](#)
 - Document Processor Open/Close Handle [2-5](#)
 - dpi [11-24](#)
 - Duplex [3-37](#), [4-7](#)
 - Duplex Unit [2-3](#)
- E**
- EcoPrint [3-46](#), [11-24](#)
 - Copy [3-46](#)
 - Printer [9-17](#)
 - E-mail Subject/Body [6-40](#)
 - Emulation [11-24](#)
 - Selection [9-17](#)
 - Encrypted PDF Password [7-27](#)
 - Energy Saving Control Function [1-12](#)
 - Energy Star Program [1-12](#)
 - Enhanced WSD [9-22](#), [11-24](#)
 - Envelopes [11-17](#)
 - Environment [1-3](#)
 - Error Handling [9-13](#)
 - Error Messages [10-13](#)
 - Expansion Memory [11-3](#)
- F**
- Favorites [3-17](#)
 - Editing and Deleting [3-21](#)
 - Registering [3-17](#)
 - Using [3-23](#)
 - Favorites/Application
 - Application [9-16](#)
 - Default Screen [9-16](#)
 - File Format [3-50](#)
 - File Name Entry [3-56](#)
 - File Separation [6-39](#)
 - First Print Time [11-21](#)
 - Format SSD [9-14](#)
 - FTP [11-24](#)
 - FTP Client (Transmission)
 - Protocol Detail [9-21](#)
 - FTP Encrypted TX [6-41](#)
 - FTP Server (Reception)
 - Protocol Detail [9-21](#)
 - Fuser Cover [2-3](#)
- G**
- Glossary [11-23](#)
 - GPL/LGPL [1-9](#)
 - Grayscale [3-53](#), [11-24](#)
- H**
- Hagaki [11-17](#)
 - Handholds [2-5](#)
 - Help [11-24](#)
 - Help Screen [3-31](#)
 - Host Name [9-19](#)
 - HTTP
 - Protocol Detail [9-21](#)
 - HTTPS
 - Protocol Detail [9-21](#)
 - HTTP Security [9-22](#)
 - Hue Adjustment [4-13](#)
- I**
- Inner Tray [2-2](#)
 - Install
 - Macintosh [2-21](#)
 - Software [2-15](#)
 - Windows [2-16](#)
 - Interface Block [9-26](#)
 - Internet
 - Proxy [9-16](#)
 - IP Address [11-24](#)
 - Setup [9-19](#)
 - IPP
 - Protocol Detail [9-21](#)
 - IPP over SSL
 - Protocol Detail [9-21](#)
 - IPP Security [9-22](#)
 - IPSec
 - Setup [9-22](#)
- J**
- Job
 - Canceling [3-32](#)
 - Checking History [8-7](#)
 - Checking Status [8-2](#)
 - Details of the Status Screens [8-3](#)
 - Pause and Resumption [8-3](#)
 - Sending the Log History [8-8](#)

- Job Accounting [9-63](#)
 - Adding an Account [9-69](#)
 - Counting the Number of Pages Printed [9-75](#)
 - Default Setting [9-78](#)
 - Editing and Deleting [9-71](#)
 - Enabling/Disabling [9-66](#)
 - Login [9-67](#)
 - Logout [9-67](#)
 - Printing an Accounting Report [9-77](#)
 - Restricting the Use of the Machine [9-73](#)
- Job Box [5-6](#)
 - Automatic Delete Setting for Temporary Documents [5-11](#)
 - Private Print/Stored Job [5-6](#)
 - Quick Copy/Proof and Hold [5-8](#)
- Job Finish Notice [3-54](#)
- JPEG/TIFF Print [7-28](#)

K

- Keyboard Layout [9-14](#)
- KPDL [11-24](#)

L

- Label [11-16](#)
- Language [9-5](#)
- LAN Interface [9-23](#)
- LDAP
 - Protocol Detail [9-21](#)
- LDAP Security [9-23](#)
- Legal Information [1-9](#)
- Legal Restriction on Copying [1-8](#)
- Legal Restriction on Scanning [1-8](#)
- LINE connector [2-4](#)
- Login [3-15](#), [9-67](#)
- Logout [3-16](#), [9-67](#)
- Lower Feed Cover [2-2](#)
- Low Power Mode [2-27](#)
- Low Toner Alert Level [9-13](#)
- LPD
 - Protocol Detail [9-21](#)

M

- Machine Setup Wizard [2-29](#)
- Main Power Switch [2-2](#)
- Manual Setting (IPv6) [9-20](#)
- Measurement [9-13](#)
- Monotype Imaging License Agreement [1-11](#)
- Multi Purpose Tray [2-2](#), [11-25](#)
 - Loading Paper [3-6](#)
 - Paper Size and Media Type [3-29](#), [9-8](#)
- Multi Sending [6-23](#)

N

- NetBEUI [11-25](#)
 - Protocol Detail [9-21](#)
- Network
 - Preparing [2-8](#)
 - Setup [2-29](#), [9-19](#)

- Network Cable
 - Connecting [2-10](#)
- Network Indicators [2-4](#)
- Network Interface [2-9](#)
- Network Interface (Send) [9-25](#)
- Network Interface Connector [2-4](#)

O

- One Touch Key [6-33](#)
 - Adding a Destination [6-33](#)
 - Editing and Deleting [6-35](#)
- Open SSL License [1-9](#)
- Operation Panel [2-2](#), [2-6](#)
- Option
 - Card Authentication Kit [11-4](#)
 - Expansion Memory [11-3](#)
 - Network Interface Kit [11-5](#)
 - Overview [11-2](#)
 - Paper Feeder [11-2](#)
 - SSD [11-4](#)
 - ThinPrint Option [11-5](#)
 - Wireless Network Interface Kit [11-5](#)
- Optional Function [11-6](#)
- Optional Memory [9-26](#)
- Optional Network
 - Basic [9-25](#)
 - Wireless Network [9-24](#)
- Option Interface Slot 1 [2-4](#)
- Option Interface Slot 2 [2-4](#)
- Original Eject Table [2-5](#)
- Original Image [3-45](#)
- Original Orientation [3-36](#)
- Originals
 - Custom Original Size [9-9](#)
 - Default Original Size [9-9](#)
 - Loading Originals [3-10](#)
 - Original Size [3-35](#)
- Original Size [3-35](#)
- Original SSLeay License [1-10](#)
- Original Stopper [2-5](#)
- Original Table [2-5](#)
- Original Width Guides [2-5](#)

P

- Paper 11-11
 - Appropriate Paper 11-12
 - Before Loading 3-2
 - Cassette 9-7
 - Checking the Remaining Amount of Paper 8-16
 - Custom Paper Size 9-10
 - Default Paper Source 9-10
 - Loading Envelopes 3-8
 - Loading in the Cassettes 3-3
 - Loading in the Multi Purpose Tray 3-6
 - Media for Auto 9-10
 - Media Type Setting 9-10
 - Multi Purpose Tray 9-8
 - Setup 9-10
 - Size and Media 3-29, 9-7
 - Special Paper 11-15
 - Special Paper Action 9-10
 - Specifications 11-12
- Paper Feeder 11-2
- Paper Feed Mode 9-18
- Paper Gauge 2-2, 3-5
- Paper Jam 10-22
 - Cassette 10-23
 - Document Processor 10-26
 - Inside the Machine 10-24
 - Multi Purpose Tray 10-23
 - Paper Feeder 10-24
 - Paper Jam Location 10-22
- Paper Length Guide 2-5
- Paper Ramp 2-3
- Paper Selection 3-41
- Paper Size Dial 2-5, 3-4
- Paper Stopper 2-2, 3-5
- Paper Transfer Unit 2-3
- Paper Type Indicators 11-18
- Paper Width Guides 2-5
- Part Names 2-2
- PDF/A 11-25
- Platen 2-5
- POP3 11-25
- POP3 (E-mail RX)
 - Protocol Detail 9-21
- PostScript 11-25
- Power Cable
 - Connecting 2-11
- Power Cord Connector 2-4
- Power Off 2-13
- Power On 2-13
- PPM 11-25
- Precautions for Use 1-3
- Preparing Cables 2-9
- Preprinted Paper 11-17
- Preset Limit 9-13
- Printer Driver 11-25

Printer Settings

- Auto cassette Change 9-18
- Color Setting 9-17
- Copies 9-17
- CR Action 9-17
- Duplex 9-17
- EcoPrint 9-17
- Emulation 9-17
- Form Feed TimeOut 9-17
- Gloss Mode 9-18
- Job Name 9-17
- LF Action 9-17
- Orientation 9-17
- Override A4/Letter 9-17
- Paper Feed Mode 9-18
- User Name 9-17
- Wide A4 9-17

Printing 5-1

Printing Speed 11-21

Priority Override 3-57

Q

- Quick Setup Wizard 3-29

R

- RA (Stateless) 11-25
 - Setup 9-20
- RAW Port
 - Protocol Detail 9-21
- Rear Cover 2-4
- Rear Cover Lever 2-4
- Recycled Paper 1-12, 11-18
- Regarding Trade Names 1-9
- Report Print 9-5
 - Accounting Report 9-6
 - Font List 9-5
 - Network Status 9-5
 - Service Status 9-6
 - Status Page 9-5
- Resolution 11-20, 11-21
- Restart 9-4
- Restart Network 9-23
- Result Report Settings 9-6
- Right Cover 2-4

S

- Safety Conventions in This Guide 1-2
- Saturation 4-15
- Scan Resolution 3-44
- Secure Protocol 9-22
- Send as E-mail 6-2, 11-25
 - E-mail Subject/Body 6-40
- Sending 6-1
 - Preparation for Sending a Document to a PC 6-5
 - Send as E-mail 6-2
 - Send to Folder (SMB/FTP) 6-2
- Sending Size 6-37

- Send Settings
 - Color TIFF Compression [9-15](#)
 - Default Screen [9-15](#)
 - Dest. Check before Send [9-15](#)
 - Entry Check for New Dest. [9-15](#)
 - Send and Forward [9-15](#)
 - Serial Number [3-13](#)
 - Sharpness [3-47](#)
 - Shortcuts
 - Editing and Deleting [3-27](#)
 - Registering [3-25](#)
 - Using [3-28](#)
 - Simple Login [3-16](#)
 - Sleep [2-28](#)
 - Sleep Level (Energy Saver) (models except for Europe) [2-28](#)
 - Sleep Rules (models for Europe) [2-28](#)
 - Slit Glass [2-5](#)
 - SMB Client (Transmission)
 - Protocol Detail [9-21](#)
 - SMTP [11-26](#)
 - SMTP (E-mail TX)
 - Protocol Detail [9-21](#)
 - SNMP
 - Protocol Detail [9-21](#)
 - SNMPv3
 - Protocol Detail [9-21](#)
 - Solving Malfunctions [10-8](#)
 - Sound [9-9](#)
 - Specifications
 - Common Functions [11-19](#)
 - Copy Functions [11-20](#)
 - Document Processor [11-22](#)
 - Environmental Specifications [11-22](#)
 - Printer Functions [11-21](#)
 - Scanner [11-21](#)
 - Status/Job Cancel [8-1](#)
 - Status Page [11-26](#)
 - Storing Size [7-30](#)
 - Subnet Mask [11-26](#)
 - Setup [9-19](#)
 - Symbols [1-2](#)
 - System/Network
 - Network Interface (Send) [9-25](#)
 - Optional Network [9-24](#)
 - System Menu [9-2](#)
- T**
- TCP/IP [11-26](#)
 - TCP/IP (IPv4)
 - Setup [9-19](#)
 - TCP/IP (IPv6) [11-26](#)
 - Setup [9-20](#)
 - TEL connector [2-4](#)
 - Thick Paper [11-17](#)
 - ThinPrint
 - Protocol Detail [9-21](#)
 - ThinPrintOverSSL
 - Protocol Detail [9-21](#)
- Toner Container [2-3](#)
 - Checking the Remaining Amount of Toner [8-16](#)
 - Replacement [10-2](#)
 - Top Cover [2-3](#)
 - Top Cover Lever [2-5](#)
 - Touch Panel [2-7](#)
 - Transparencies [11-15](#)
 - TWAIN [11-26](#)
 - Setting TWAIN Driver [2-24](#)
- U**
- Unknown Login User Name Job [9-79](#)
 - USB [11-26](#)
 - USB Cable
 - Connecting [2-11](#)
 - USB Interface [2-9](#)
 - USB Interface Connector [2-4](#)
 - USB Keyboard Type [9-14](#)
 - USB Memory
 - Printing Documents [7-17](#)
 - Removing [7-22](#)
 - Saving Documents [7-20](#)
 - USB Memory Slot [2-2](#)
 - User Login Administration [9-36](#)
 - Adding a User [9-40](#)
 - Editing and Deleting [9-47](#)
 - Enabling/Disabling [9-38](#)
 - Group Authorization [9-57](#)
 - Local User Authorization [9-45](#)
 - My Panel [9-46](#)
 - Obtain Network User Property [9-61](#)
 - Simple Login [9-51](#)
 - User Property [9-7](#)
- W**
- Waste Toner Box [2-3](#)
 - Replacement [10-4](#)
 - Waste Toner Cover [2-3](#)
 - WIA [11-26](#)
 - Setting WIA Driver [2-26](#)
 - WSD Print
 - Setup [9-22](#)
 - WSD Scan [6-42](#)
 - Setup [9-22](#)
- X**
- XPS Fit to Page [7-29](#)
- Z**
- Zoom
 - Copy [4-5](#)
 - Send/Store [3-49](#)



**QUALITY
CERTIFICATE**

This machine has passed
all quality controls and
final inspection.

KYOCERA Document Solutions America, Inc.**Headquarters**

225 Sand Road,
Fairfield, New Jersey 07004-0008, USA
Phone: +1-973-808-8444
Fax: +1-973-882-6000

Latin America

8240 NW 52nd Terrace Dawson Building, Suite 100
Miami, Florida 33166, USA
Phone: +1-305-421-6640
Fax: +1-305-421-6666

KYOCERA Document Solutions Canada, Ltd.

6120 Kestrel Rd., Mississauga, ON L5T 1S8,
Canada
Phone: +1-905-670-4425
Fax: +1-905-670-8116

**KYOCERA Document Solutions
Mexico, S.A. de C.V.**

Calle Arquimedes No. 130, 4 Piso, Colonia Polanco
Chapultepec, Delegacion Miguel Hidalgo,
Distrito Federal, C.P. 11560, México
Phone: +52-555-383-2741
Fax: +52-555-383-7804

KYOCERA Document Solutions Brazil, Ltda.

Av. Tambore, 1180 Mod. B-09 CEP 06460-000
Tambore-Barueri-SP, Brazil
Phone: +55-11-4195-8496
Fax: +55-11-4195-6167

**KYOCERA Document Solutions
Australia Pty. Ltd.**

Level 3, 6-10 Talavera Road North Ryde N.S.W, 2113,
Australia
Phone: +61-2-9888-9999
Fax: +61-2-9888-9588

**KYOCERA Document Solutions
New Zealand Ltd.**

Ground Floor, 19 Byron Avenue, Takapuna, Auckland,
New Zealand
Phone: +64-9-415-4517
Fax: +64-9-415-4597

KYOCERA Document Solutions Asia Limited

16/F., Mita Centre, 552-566, Castle Peak Road
Tsuenwan, NT, Hong Kong
Phone: +852-2610-2181
Fax: +852-2610-2063

**KYOCERA Document Solutions
(China) Corporation**

8F, No. 288 Nanjing Road West, Huangpu District,
Shanghai, 200003, China
Phone: +86-21-5301-1777
Fax: +86-21-5302-8300

**KYOCERA Document Solutions
(Thailand) Corp., Ltd.**

335 Ratchadapisek Road, Bangsue, Bangkok 10800,
Thailand
Phone: +66-2-586-0333
Fax: +66-2-586-0278

**KYOCERA Document Solutions
Singapore Pte. Ltd.**

12 Tai Seng Street #04-01A,
Luxasia Building, Singapore 534118
Phone: +65-6741-8733
Fax: +65-6748-3788

**KYOCERA Document Solutions
Hong Kong Limited**

16/F., Mita Centre, 552-566, Castle Peak Road
Tsuenwan, NT, Hong Kong
Phone: +852-3582-4000
Fax: +852-3185-1399

**KYOCERA Document Solutions
Taiwan Corporation**

6F., No. 37, Sec. 3, Minquan E. Rd.,
Zhongshan Dist., Taipei 104, Taiwan R.O.C.
Phone: +886-2-2507-6709
Fax: +886-2-2507-8432

KYOCERA Document Solutions Korea Co., Ltd.

18F, Kangnam bldg, 1321-1,
Seocho-Dong, Seocho-Gu, Seoul, Korea
Phone: +822-6933-4050
Fax: +822-747-0084

**KYOCERA Document Solutions
India Private Limited**

First Floor, ORCHID CENTRE
Sector-53, Golf Course Road, Gurgaon 122 002,
India
Phone: +91-0124-4671000
Fax: +91-0124-4671001

KYOCERA Document Solutions Europe B.V.

Bloemlaan 4, 2132 NP Hoofddorp,
The Netherlands
Phone: +31-20-654-0000
Fax: +31-20-653-1256

KYOCERA Document Solutions Nederland B.V.

Beechavenue 25, 1119 RA Schiphol-Rijk,
The Netherlands
Phone: +31-20-5877200
Fax: +31-20-5877260

KYOCERA Document Solutions (U.K.) Limited

Eldon Court, 75-77 London Road,
Reading, Berkshire RG1 5BS,
United Kingdom
Phone: +44-118-931-1500
Fax: +44-118-931-1108

KYOCERA Document Solutions Italia S.p.A.

Via Verdi, 89/91 20063 Cernusco s/N.(MI),
Italy
Phone: +39-02-921791
Fax: +39-02-92179-600

KYOCERA Document Solutions Belgium N.V.

Sint-Martinusweg 199-201 1930 Zaventem,
Belgium
Phone: +32-2-7209270
Fax: +32-2-7208748

KYOCERA Document Solutions France S.A.S.

Espace Technologique de St Aubin
Route de l'Orme 91195 Gif-sur-Yvette CEDEX,
France
Phone: +33-1-69852600
Fax: +33-1-69853409

KYOCERA Document Solutions Espana, S.A.

Edificio Kyocera, Avda. de Manacor No.2,
28290 Las Matas (Madrid), Spain
Phone: +34-91-6318392
Fax: +34-91-6318219

KYOCERA Document Solutions Finland Oy

Atomitie 5C, 00370 Helsinki,
Finland
Phone: +358-9-47805200
Fax: +358-9-47805390

**KYOCERA Document Solutions
Europe B.V., Amsterdam (NL) Zürich Branch**

Hohlstrasse 614, 8048 Zürich,
Switzerland
Phone: +41-44-9084949
Fax: +41-44-9084950

**KYOCERA Document Solutions
Deutschland GmbH**

Otto-Hahn-Strasse 12, 40670 Meerbusch,
Germany
Phone: +49-2159-9180
Fax: +49-2159-918100

KYOCERA Document Solutions Austria GmbH

Eduard-Kittenberger-Gasse 95, 1230 Vienna,
Austria
Phone: +43-1-863380
Fax: +43-1-86338-400

KYOCERA Document Solutions Nordic AB

Esbogatan 16B 164 75 Kista, Sweden
Phone: +46-8-546-550-00
Fax: +46-8-546-550-10

KYOCERA Document Solutions Norge Nuf

Postboks 150 Oppsal, 0619 Oslo,
Norway
Phone: +47-22-62-73-00
Fax: +47-22-62-72-00

KYOCERA Document Solutions Danmark A/S

Ejby Industrivej 60, DK-2600 Glostrup,
Denmark
Phone: +45-70223880
Fax: +45-45765850

KYOCERA Document Solutions Portugal Lda.

Rua do Centro Cultural, 41 (Alvalade) 1700-106 Lisboa,
Portugal
Phone: +351-21-843-6780
Fax: +351-21-849-3312

**KYOCERA Document Solutions
South Africa (Pty) Ltd.**

KYOCERA House, Hertford Office Park,
90 Bekker Road (Cnr. Allandale), Midrand, South Africa.
Phone: +27-11-540-2600
Fax: +27-11-466-3050

KYOCERA Document Solutions Russia LLC

Botanichesky pereulok 5, Moscow, 129090,
Russia
Phone: +7(495)741-0004
Fax: +7(495)741-0018

KYOCERA Document Solutions Middle East

Dubai Internet City, Bldg. 17,
Office 157 P.O. Box 500817, Dubai,
United Arab Emirates
Phone: +971-04-433-0412

KYOCERA Document Solutions Inc.

2-28, 1-chome, Tamatsukuri, Chuo-ku
Osaka 540-8585, Japan
Phone: +81-6-6764-3555
<http://www.kyoceradocumentsolutions.com>

